



Application Guide

wet Area Construction

INTERIORS

Australia March 2022

Make sure your information is up to date.

When specifying or installing James Hardie™ products, ensure you have the current installation guide. If in doubt, or you need more information, visit www.jameshardie.com.au or Ask James Hardie™ on 13 11 03.

1 INTRODUCTION

James Hardie manufactures a wide range of building products ideally suited for use in wet areas such as bathrooms, toilets and laundries.

Repairs to wet areas such as bathrooms are a nightmare for both homeowner and builder alike. They can be extremely costly, lengthy and disruptive. For this reason it is important to ensure reputable, qualified and skilful tradespeople do the job and suitable and durable building products are used.

When it comes to building product performance, James Hardie leads the industry with durable wall linings, structural flooring sheets and ceramic tile underlays.

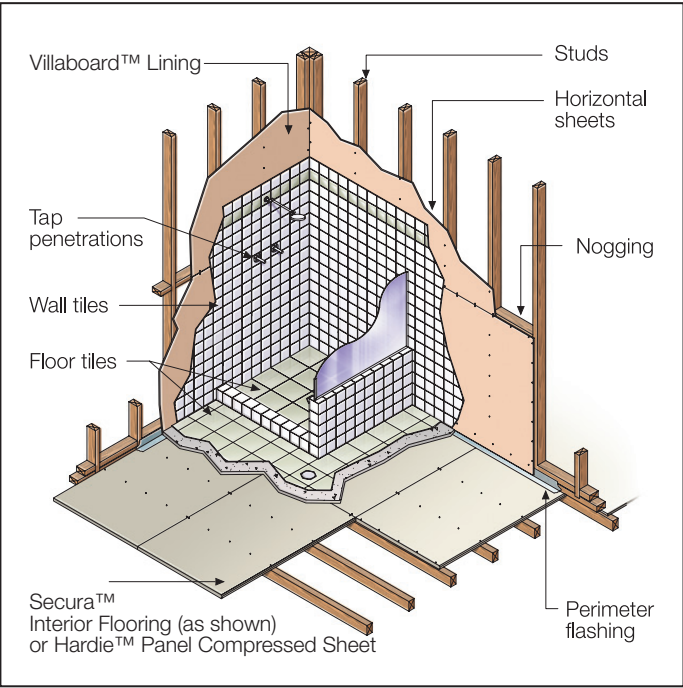

Hardie™ building products offer superior durability and are resistant to moisture, rotting, cracking, fire and termites when installed and maintained correctly.

This manual covers the use of Hardie™ building products in wet areas. For information relating to the installation, accessories, tools and safe work practices of any Hardie™ products refer to the current installation manual and current building code of Australia and AS 3740.

The specifier or other responsible party for the project must ensure the information and details in this guide are appropriate for the intended application and specific design and detailing is undertaken for areas which fall outside the scope of this documentation.

Make sure your information is up to date

When specifying or installing Hardie™ products, ensure you have the current manual. Additional installation information, warranties and warnings are available at www.jameshardie.com.au or Ask James Hardie™ on 13 11 03.

CONTENTS

- 1 INTRODUCTION 2**
- 2 SUITABLE WET AREA SUBSTRATES 3**
 - Wall and ceiling linings 3
 - Structural flooring sheets 3
 - Tile underlays 3
- 3 COMPLIANCE REQUIREMENTS 4**
 - Building Code of Australia 4
 - Australian Standard AS 3740 4
 - Scope of this manual 4
 - Definitions 4
 - Waterproofing requirements 5
 - Benefits of Hardie™ building products 5
- 4 FRAMING 6**
- 5 WALL FLASHING 7**
 - Floor/wall junction 7
 - External flashing 7
 - Internal flashing 8
 - Doorway flashing 8
 - Vertical corner flashing 9
- 6 ENCLOSED SHOWERS 10**
 - General 10
 - External membranes 10
 - Preformed trays and bases 11
 - Internal membranes 12
 - Shower over baths 12
 - Shower edge details 13
- 7 UNENCLOSED SHOWERS 14**
- 8 BATHS, BASINS AND TUBS 15**
 - Baths 15
 - Basins and tubs 15
- 9 PENETRATIONS 16**
 - Wall penetrations 16
 - Floor penetrations 16
- 10 APPENDIX A 17**

2 SUITABLE WET AREA SUBSTRATES

WALL AND CEILING LININGS

Villaboard™ Lining

A durable wet area wall and ceiling lining sheet which is a suitable surface for tiled or painted finishes. Available in 6mm and 9mm thickness, Villaboard™ Lining has its long edges recessed for easy flush-jointing.

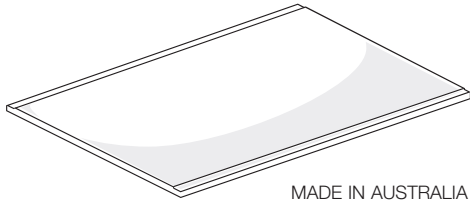

TILE UNDERLAYS

Hardie™ Ceramic Tile Underlay

A larger underlay sheet with pre-marked nailing pattern on the face. The larger board size makes it ideal for bigger bathrooms and large floor areas.

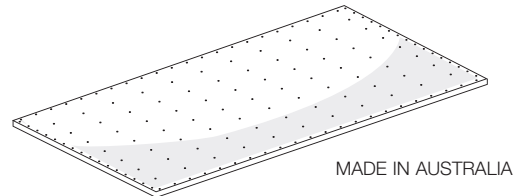

STRUCTURAL FLOORING SHEETS

Secura™ Interior Flooring

It is based on Scyon™ technology. It is a 19mm thick structural flooring tongue and grooved alternate to timber, particle board or plywood flooring. It is lighter than traditional compressed fibre cement and durable with the installation ease of particle board.

Secura™ Interior Flooring has been approved by CSIRO (Technical Assessment 318, July 2005) as satisfying the relevant requirements for use in wet areas.

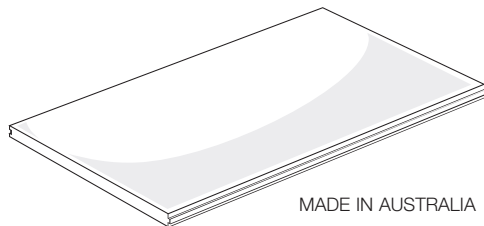

Hardie™ Panel Compressed Sheet

As a structural flooring alternative to timber, particle board or plywood flooring, Hardie™ Panel Compressed Sheet provide an excellent substrate for ceramic tiles in wet areas.

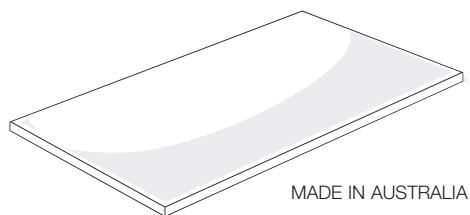

3 COMPLIANCE REQUIREMENTS

BUILDING CODE OF AUSTRALIA

There are two parts to the Building Code of Australia 2006 (BCA).

Volume one - Class 2 – 9 Buildings

Volume two - Class 1 and Class 10 Buildings – Housing Provisions.

In relation to the waterproofing of wet areas, BCA 2006 Volume one references Australian Standard AS 3740 - 'Waterproofing of wet areas in residential buildings' as meeting the minimum performance requirements for construction of wet areas in Class 2, 3 and 4 buildings.

Referencing AS 3740, BCA 2012, Volume two provides specific waterproofing requirements for various applications. These specific requirements are for all intents and purposes the same as those provided in AS 3740.

AUSTRALIAN STANDARD AS 3740 - 2010

AS 3740 specifies the requirements for the physical elements of construction including floors, walls, junctions and penetrations. The specific areas where these criteria apply include showers, areas adjacent to baths and spas, general wet areas and areas adjoining other vessels such as sinks, basins or tubs.

The requirements outlined in Appendix A - Table 1 are identical to those provided in Australian Standard AS 3740 (Table 2.1). Additional information relating to the extent of waterproofing required for various applications are provided in Appendix A - Table 2 (this is a copy of Table 4.1 of AS 3740).

SCOPE OF THIS MANUAL

This manual is intended to be used as a guide to assist designers, specifiers, waterproofers, builders and installers achieve construction compliance when using Hardie™ building products. It must be read in conjunction with the BCA, AS 3740: 2010 and other relevant regulations relating to wet area construction.

Installation of Hardie™ building products must be carried out in accordance with the relevant product installation manual current at the time of application.

DEFINITIONS

Various terminology is used within the regulations and this manual. AS 3740 provides the following definitions:

Enclosed shower - A shower designed and installed to control the spread of water from the shower enclosure.

Flashing, perimeter - A flashing used at the floor-wall junction.

Flashing, vertical - A flashing used at wall junctions within shower areas.

Floor waste - A grated inlet within a graded floor intended to drain the floor surface.

Maximum retained water level - The point where surface water will start to overflow out of the shower area.

Membrane - A barrier impervious to moisture.

Membrane, external (external flashing) - A membrane that is installed behind the wall sheeting or render. Usually external membranes are preformed trays or sheet material systems.

Membrane, internal (internal flashing) - A membrane that is installed to the face of the wall sheeting or render. Usually internal membranes are liquid systems applied in situ.

Shower area - The area affected by water from a shower, including a shower over a bath.

Shower area, enclosed - The area enclosed by walls or screens including hinged or sliding doors that control the spread of water to within the enclosure.

Shower area, unenclosed - The area that is open on one or more sides, extending in an arc on the open sides, 1500mm from the shower connection at the wall.

Shower tray - An internal or external liquid or sheet membrane system used to waterproof the floor and the wall/floor junctions of a shower area.

Waterproof (WP) - The property of a material that does not allow moisture to penetrate through it when tested in accordance with AS/NZS 4858.

Water resistant (WR) - The property of a system or material that restricts moisture movement and will not degrade under conditions of moisture.

Wet area - An area within a building supplied with water from a water supply system and includes bathrooms, showers, laundries and sanitary compartments. Excludes kitchens, bar areas, kitchenettes or domestic food and beverage preparation areas.

WATERPROOFING REQUIREMENTS

Different waterproofing requirements are applicable to different wet area applications. Some of those typical applications are shown in Figure 1.

The various requirements for each application is covered in the following sections of this manual.

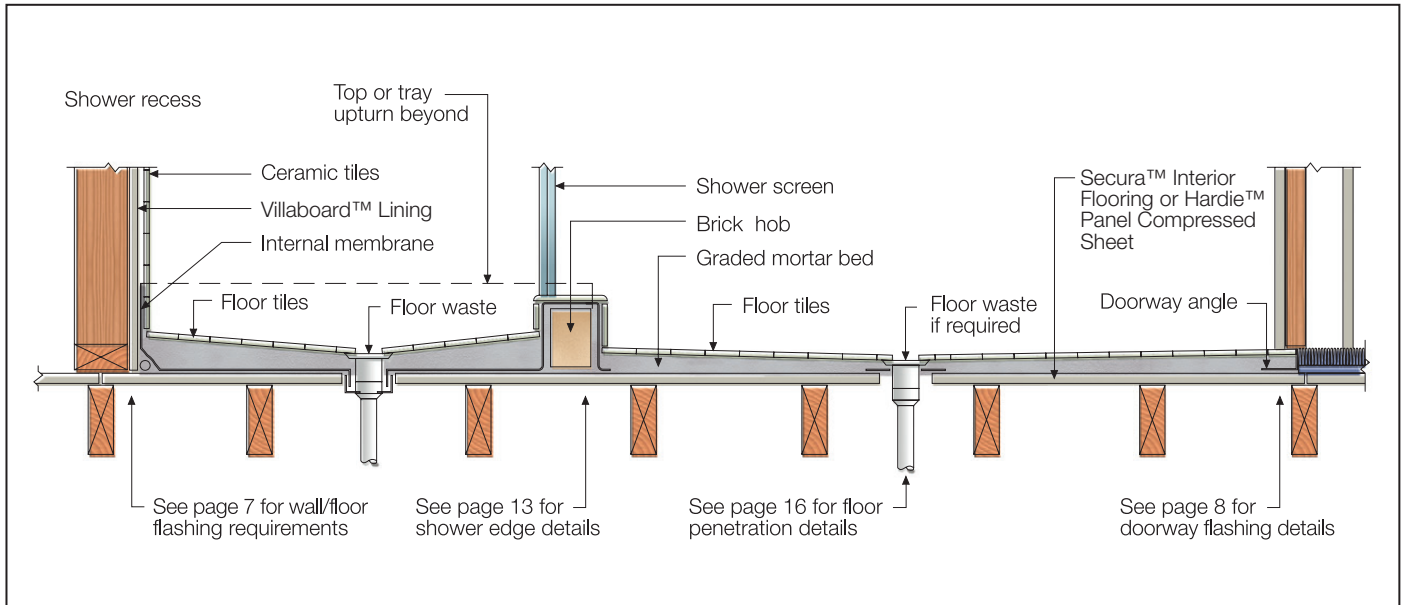

FIGURE 1 TYPICAL BATHROOM CROSS-SECTION

BENEFITS OF HARDIE™ BUILDING PRODUCTS

Hardie™ building products are resistant to moisture damage, rotting, fire, and termites when installed and maintained as directed. In addition to these benefits, when using Secura™ Interior Flooring or Hardie™ Panel Compressed Sheet, full floor waterproofing is not required outside the enclosed shower area (unless a floor waste is specified by the BCA).

Secura™ Interior Flooring has been approved by CSIRO (Technical Assessment 318, July 2005) as satisfying the relevant requirements for use in wet areas.

For walling applications, Villaboard™ Lining covered with tiles is ideal as they meet the water resistant requirements in shower areas.

4 FRAMING

Corner studs must be blocked to prevent corner cracking, see Figure 2. Where this is not possible, use a corrosion resistant non-ferrous angle minimum 35x35mm and with a bmt between 0.8 and 1.5mm, see Figure 3.

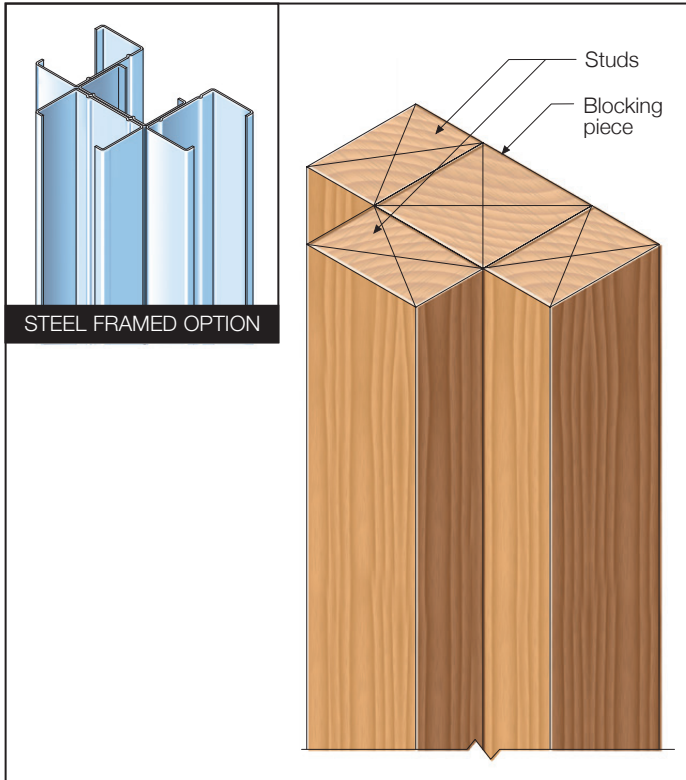

FIGURE 2 BLOCKED CORNER

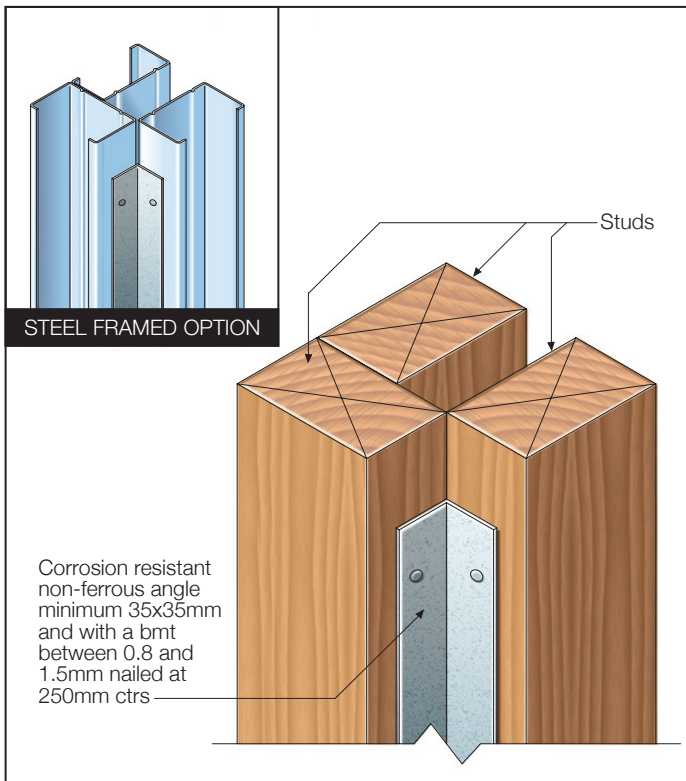

FIGURE 3 ANGLE REINFORCED CORNER - NON SHOWER AREA

NOTE

Plasterer's angle must not be used.

For vertical corner flashing requirements in shower areas, see page 9. For internal and external tiled corners located in areas not waterproofed, refer to Figures 4 and 5.

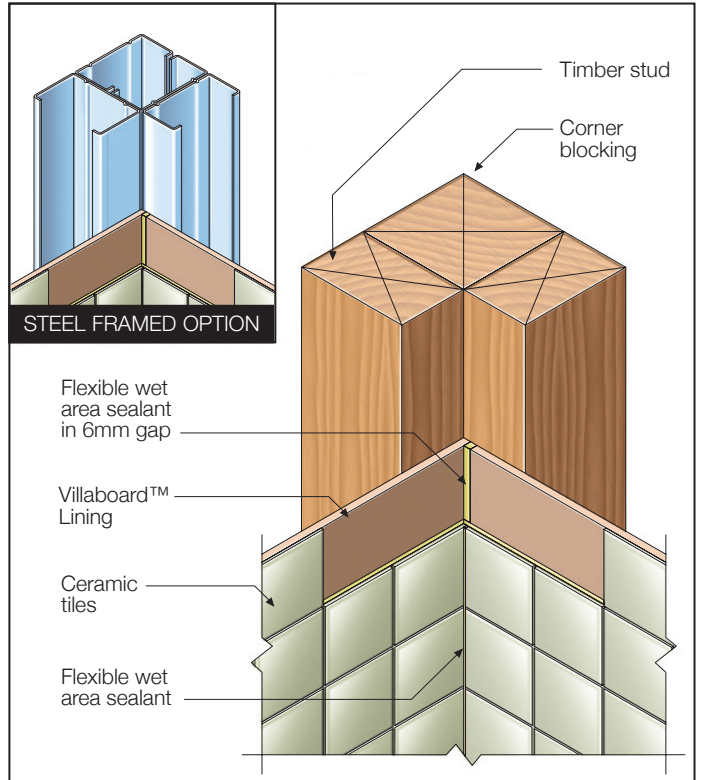

FIGURE 4 INTERNAL TILED CORNER - NON SHOWER AREA

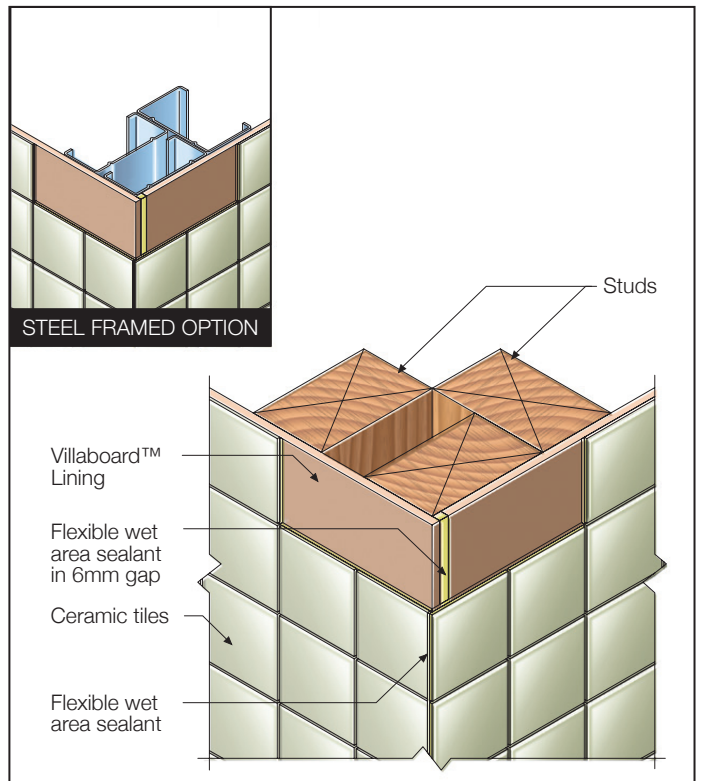

FIGURE 5 EXTERNAL TILED CORNER - NON SHOWER AREA

NOTES

1. Vertical corner flashing is required in shower recess areas.
2. External corners must not be set and plasterer's angles must not be used.

5 WALL FLASHING

FLOOR/WALL JUNCTION

The floor/wall junction requires flashing which can be either an external or internal flashing. In shower recesses, the floor/wall junction must be waterproofed to a height of 150mm above finished tile level of the floor or 25mm minimum above the maximum retained water level, whichever is the greater. This affects the required sealing of the floor to wall junctions.

All junctions in the general wet areas beyond the shower, including bathrooms, toilets and laundries (except kitchens), must be sealed with a flashing or skirting. We recommended this area is sealed with an external flashing.

The horizontal leg of perimeter flashing must be 50mm minimum, and the vertical leg must project 25mm minimum above the highest point of the finished floor surface, except at doorways. Across a doorway, the perimeter flashing angle must finish flush with the top surface of the finished floor. Adhere flashing to floor only. The floor surface must be clean of all waste and dust. Clean down the surfaces to be bonded with a damp cloth and allow to dry.

In high risk areas such as showers, do not penetrate the corner flashings.

EXTERNAL FLASHING

When using external flashing with Villaboard™ Lining, use a 75 x 50mm or 100 x 50mm PVC preformed angle flashing, in conjunction with Fulaprene 303 adhesive, see Figure 6 for Villaboard™ Lining.

NOTE

Do not fix PVC angles with HydrEpoxy 501.

NOTES

1. Where wall/floor junctions are flashed with an external angle (or when an external membrane or base is used), Villaboard™ Lining to be finished with tiles must not be fixed to bottom plates. In these cases, provide an extra row of noggings above top of the flashing/membrane for fixing Villaboard™ Lining. See Figure 13.
2. External flashings (or shower bases) must be fitted before the sheets are installed.
3. External flashing must be fixed to the floor only.
4. Ensure all elements are compatible to resist corrosion between elements.

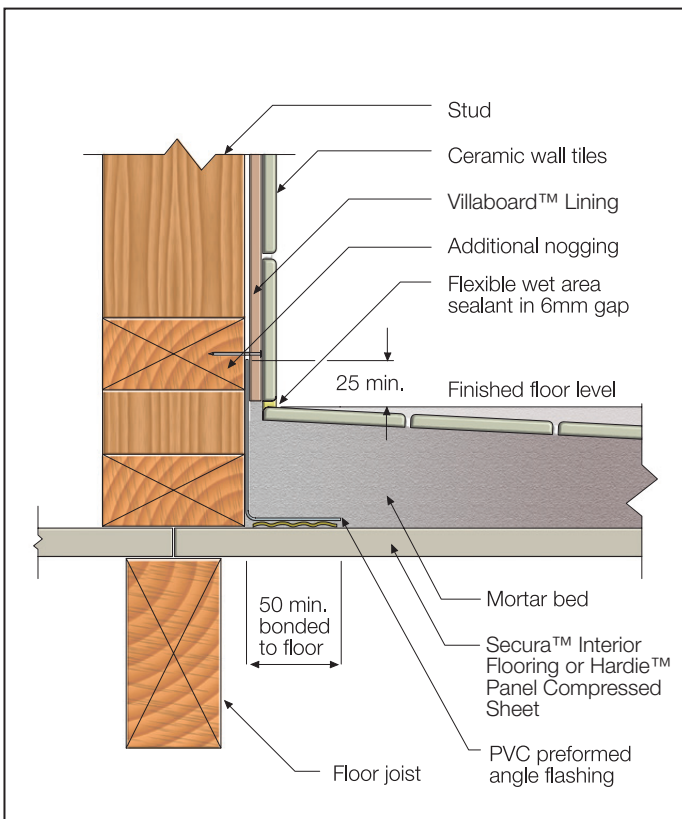

FIGURE 6 EXTERNAL PERIMETER FLASHING - VILLABOARD™ LININGS FINISHED WITH TILES

INTERNAL FLASHING

Alternatively the wall/floor junction can be flashed internally. Internal flashings are formed in-situ with fibreglass reinforced plastic, epoxy resin or acrylic emulsion, see Figure 7.

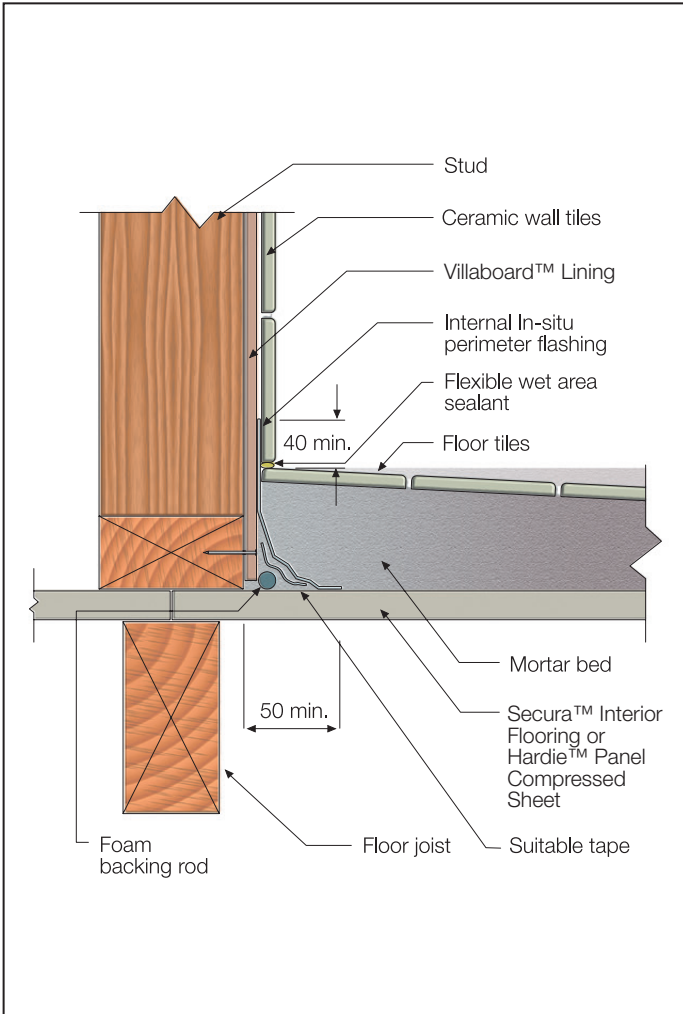

FIGURE 7 INTERNAL FLASHING

NOTE

The foam backing rod and covering masking tape form the required in-situ perimeter flashing bond breaker.

DOORWAY FLASHING

The flashing should be extended from the floor to wall flashing and remain continuous across the doorway, where it should be trimmed down to the finished height of the tiles. Where architraves and door jambs extend below the finished tiled level the waterproofing is to extend over the architraves and doorjambes to protect them from damage. At doorways provide a brass or aluminium angle to both support the perimeter flashing and protect the edges of the floor tiles, see Figure 8.

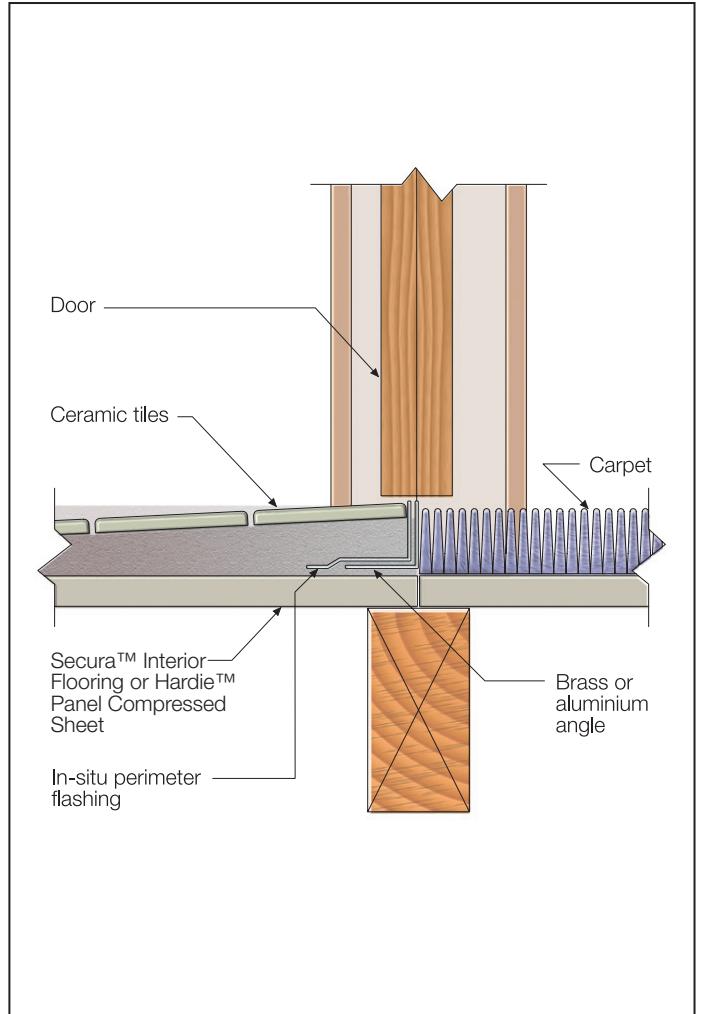

FIGURE 8 DOORWAY FLASHING

NOTE

Vertical leg angle is to be trimmed smooth to finish flush with the top surface of floor finishes.

VERTICAL CORNER FLASHING

Vertical corner flashing must be used in shower areas and extended to 1800mm above the finished floor level or base of the bath (where a shower is over the bath).

External vertical corner flashing angles can be used with external membranes only. They must have legs of sufficient width to overlap the wall lining by a minimum of 30mm for external flashing, see Figure 9. The wall lining must be sealed at the flashing with a flexible wet area sealant. At the base of the wall lining there must be an effective drainage gap to allow water on the flashing to drain into the membrane. Vertical corner flashings must overlap the top edge of external membranes by 20mm minimum.

Internal corner flashing angles can be used for both external and internal membranes. They are formed in-situ with fibreglass reinforced plastic, epoxy resin or acrylic emulsion. They must have a minimum overlap onto the wall sheeting of 40mm each side; for internal lining see Figure 10. Internal vertical corner flashings must extend vertically from the top of the membrane upturn.

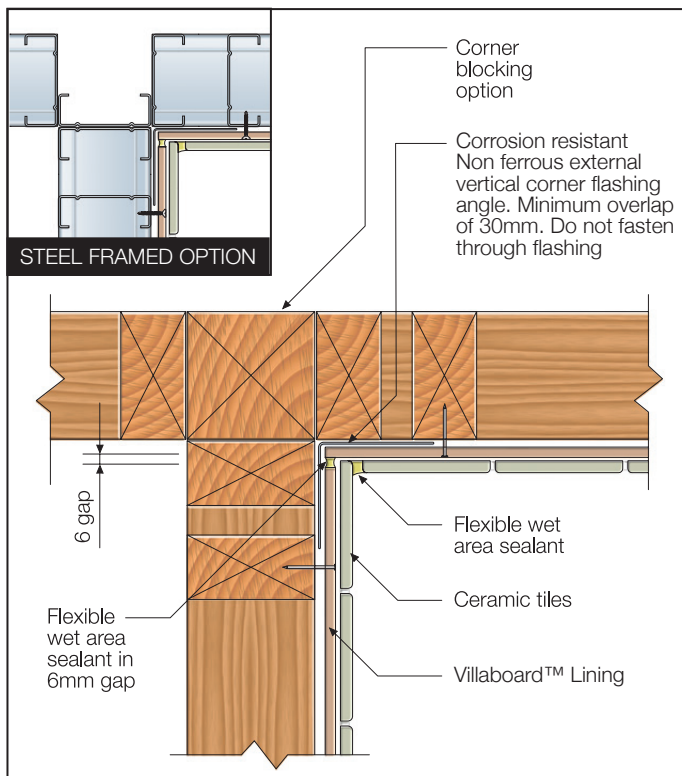

FIGURE 9 VERTICAL CORNER FLASHING FOR EXTERNAL MEMBRANE - SHOWER RECESS

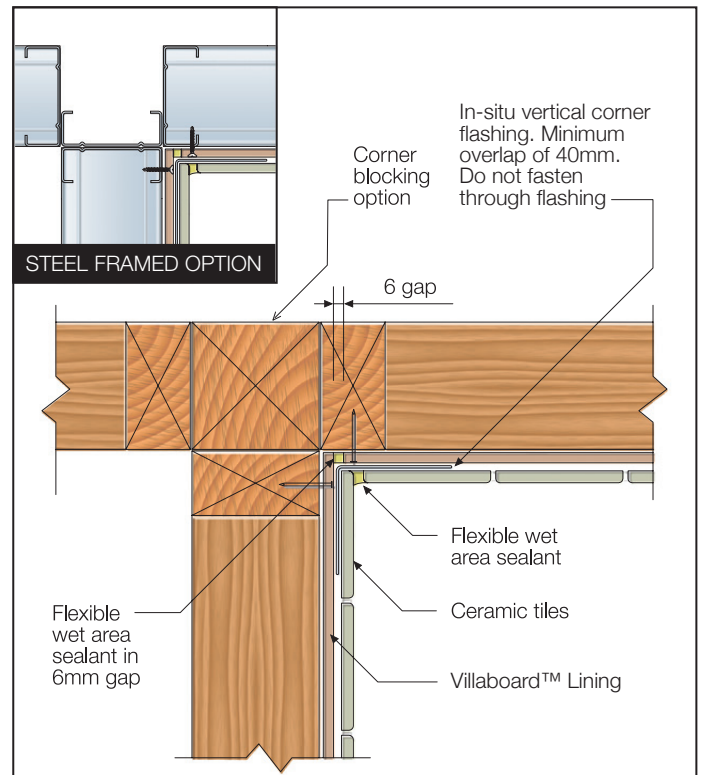

FIGURE 10 VERTICAL CORNER FLASHING FOR INTERNAL MEMBRANE - SHOWER RECESS

NOTE

This detail also applies for a shower over a bath.

6 ENCLOSED SHOWERS

GENERAL

The height of the sides of the shower tray above the highest point of the finished tiled floor surface must be 150mm high or 25mm above the maximum possible water level in the shower compartment, whichever is higher, see Figure 11. Shower trays can be external, preformed or internal.

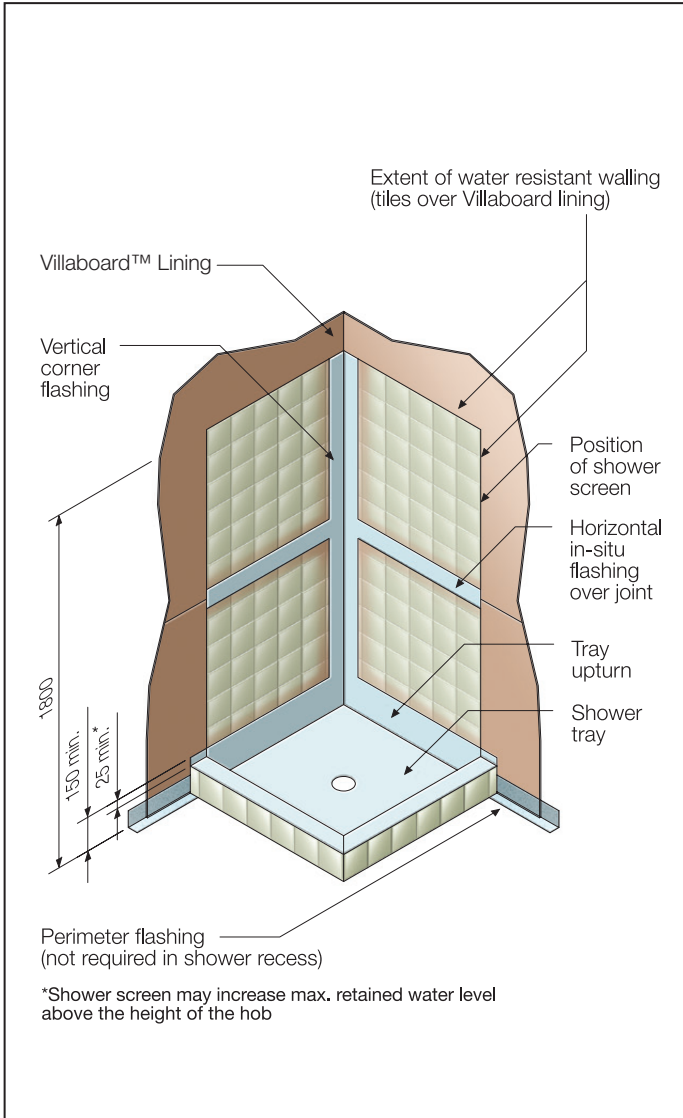

FIGURE 11 INTERNAL MEMBRANE

NOTE

The diagram above shows an internal membrane scenario. Alternatively, external membranes can also be used.

EXTERNAL MEMBRANES

These are constructed by installing a prefabricated tray manufactured from plastic, other flexible waterproofing membrane material, stainless steel or copper prior to fixing wall lining, ie the tray is on the outside of the wall lining, see Figure 12.

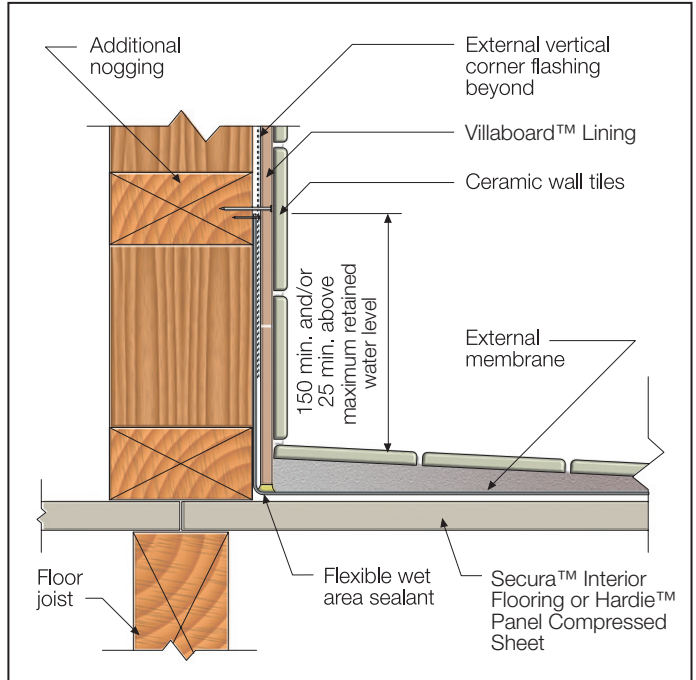

FIGURE 12 EXTERNAL MEMBRANE - VILLABOARD™ LINING

An alternative method of constructing an external tray is to use prefabricated fibreglass reinforced plastic angles, which are placed around the perimeter of the shower compartment prior to fixing the wall lining. In-situ fibreglass reinforced plastic is then applied to the remainder of the floor. Care must be taken not to glue the vertical leg of the angle to the wall framing. Membranes should be either supplied with floor wastes factory fitted or be capable of being dressed down into the waste pipe.

PREFORMED TRAYS AND BASES

With Villaboard™ Lining that will be tiled, sealing is required around preformed trays and bases, see Figure 13 respectively. These trays and bases are usually manufactured from plastic, fibreglass or stainless steel, in a variety of sizes and configurations. Preformed trays and bases must be installed to manufacturer's instructions.

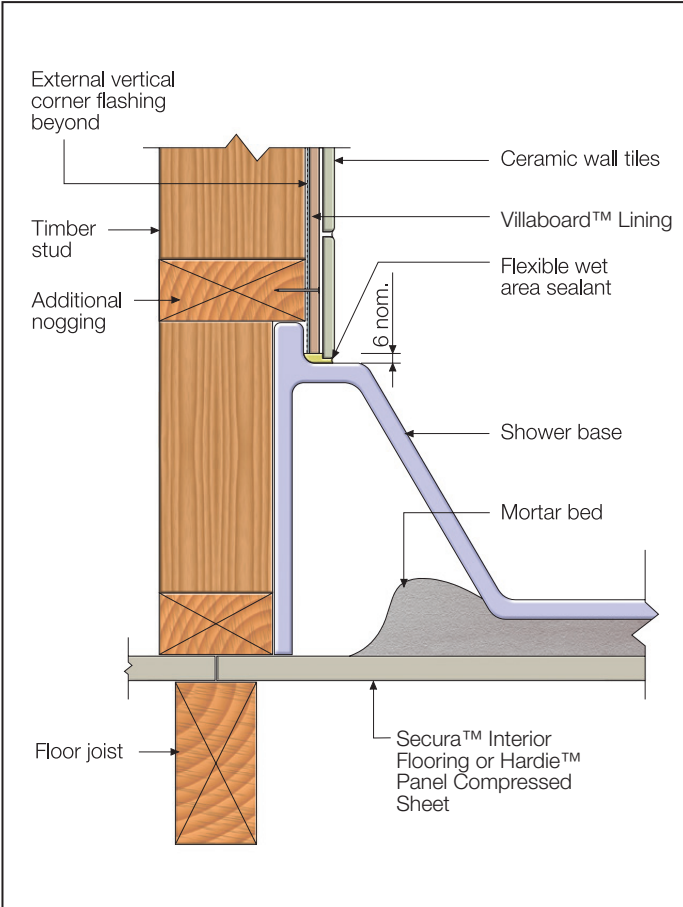

FIGURE 13A PREFORMED TRAY DETAIL FOR VILLABOARD™ LINING TO BE TILED - TIMBER FRAME

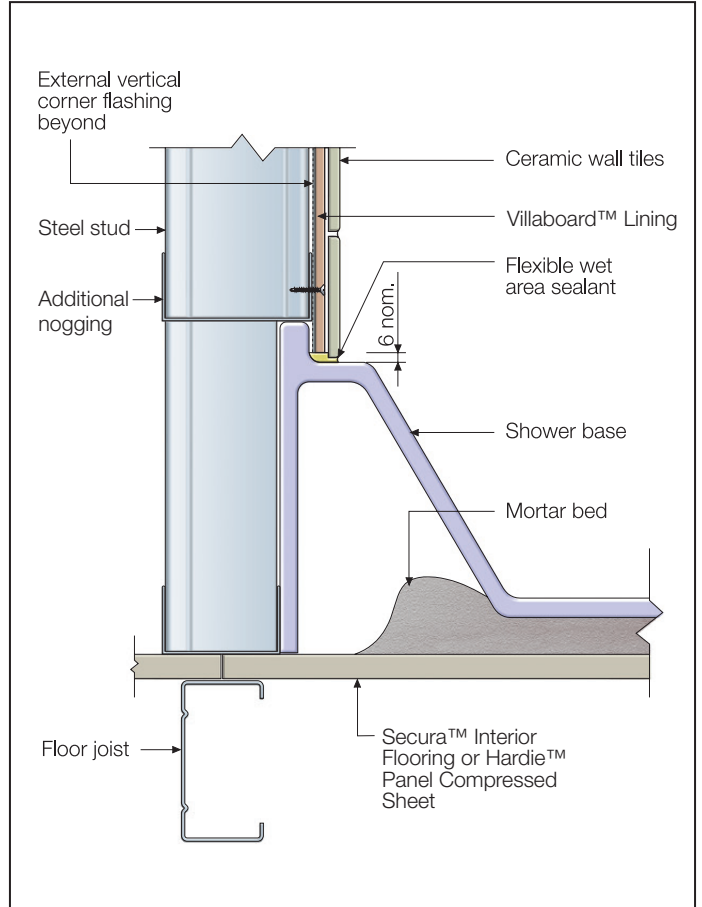

FIGURE 13B PREFORMED TRAY DETAIL FOR VILLABOARD™ LINING TO BE TILED - STEEL FRAME

INTERNAL MEMBRANES

Internal in-situ systems are applied to the face of the Villaboard™ Lining, ie the membrane is on the inside face of the wall lining. Materials commonly used include liquid compounds of rubber, acrylic or epoxy usually reinforced with fibreglass, or sheet products of rubber, plastic or other waterproofing material.

As well as having waterproofing properties, the membrane must be compatible with tile adhesives. Because internal membranes are fixed to the Villaboard™ Lining, you must allow for frame movement and a bond breaker must be incorporated in the perimeter wall/floor junction before the membrane is installed, see Figures 14 and 15.

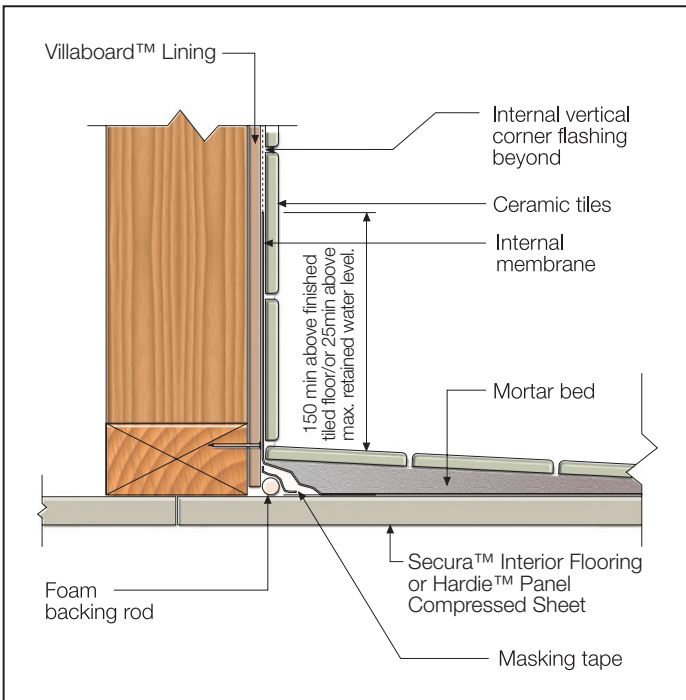

FIGURE 14 IN-SITU APPLIED INTERNAL MEMBRANE

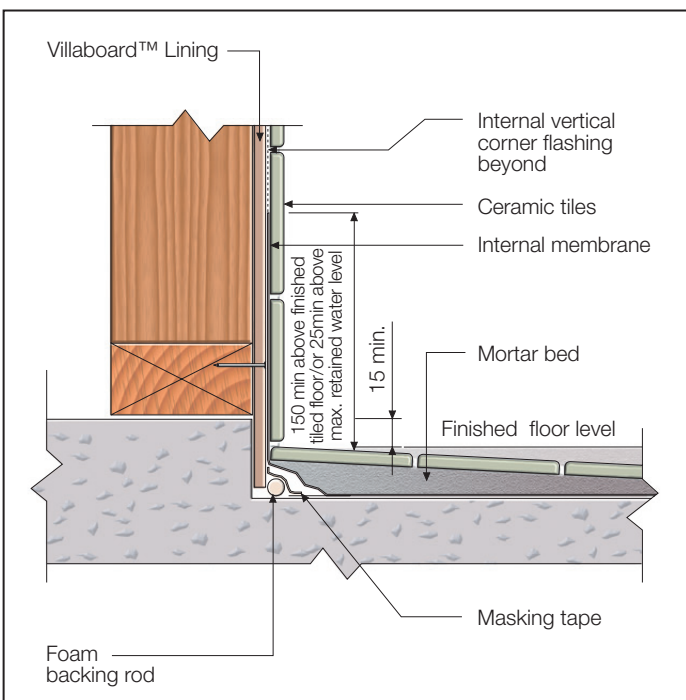

FIGURE 15A IN-SITU APPLIED INTERNAL MEMBRANE AT STEP-DOWN - TIMBER FRAME OPTION

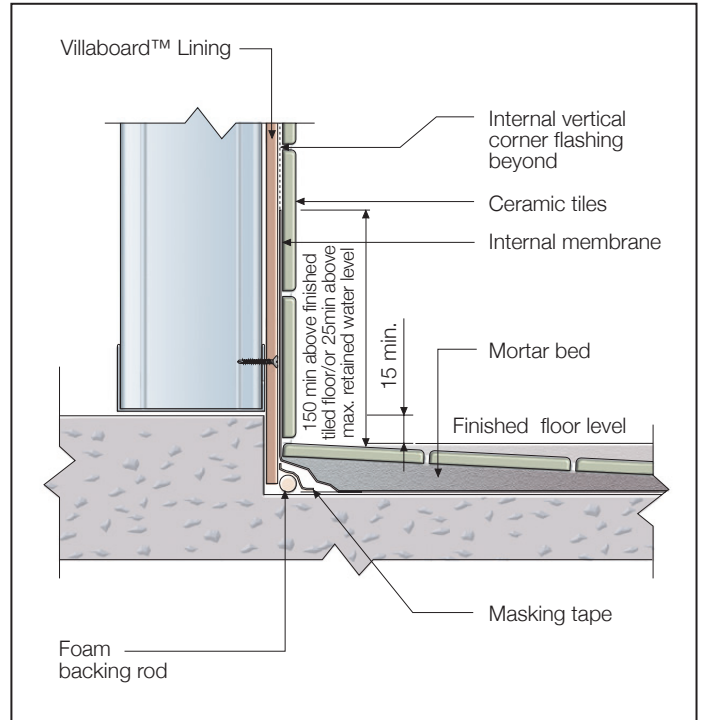

FIGURE 15B IN-SITU APPLIED INTERNAL MEMBRANE AT STEP-DOWN - STEEL FRAME OPTION

SHOWER OVER BATHS

Where an enclosed shower is positioned over a bath, it needs to be protected by a shower screen. Waterproofing of the floor or walls beyond the bath is not required, see Figure 16.

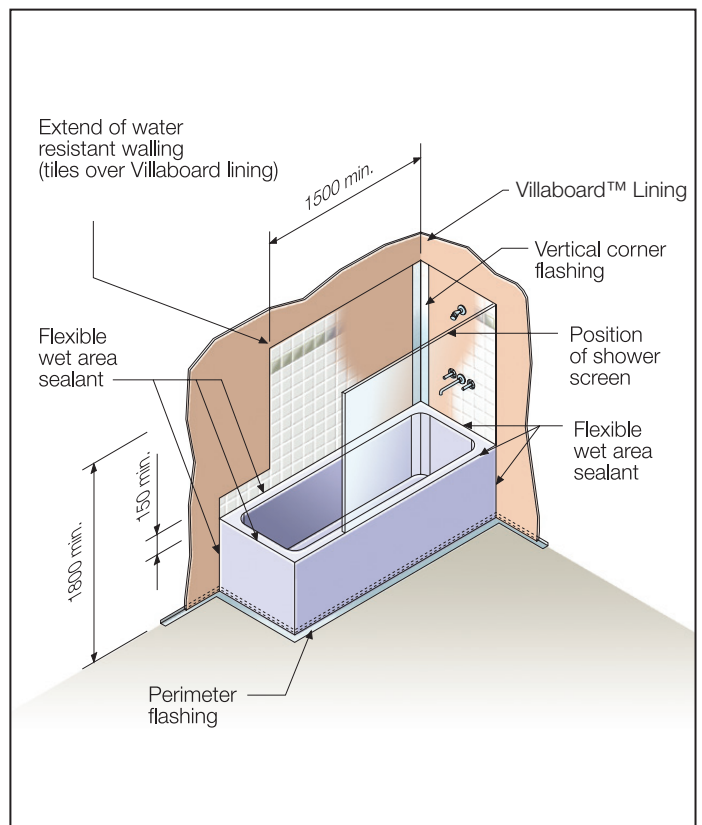

FIGURE 16 SHOWER OVER BATH - WITH SHOWER SCREEN

SHOWER EDGE DETAILS

Showers can be built with or without hobs. The hob across the entry side of a shower recess can be located either outside an internal membrane or inside an external membrane, see Figures 17 and 18 respectively.

NOTES

1. Shower screens must be on the inside edge of the hob.
2. Timber must not be used to form the hob.

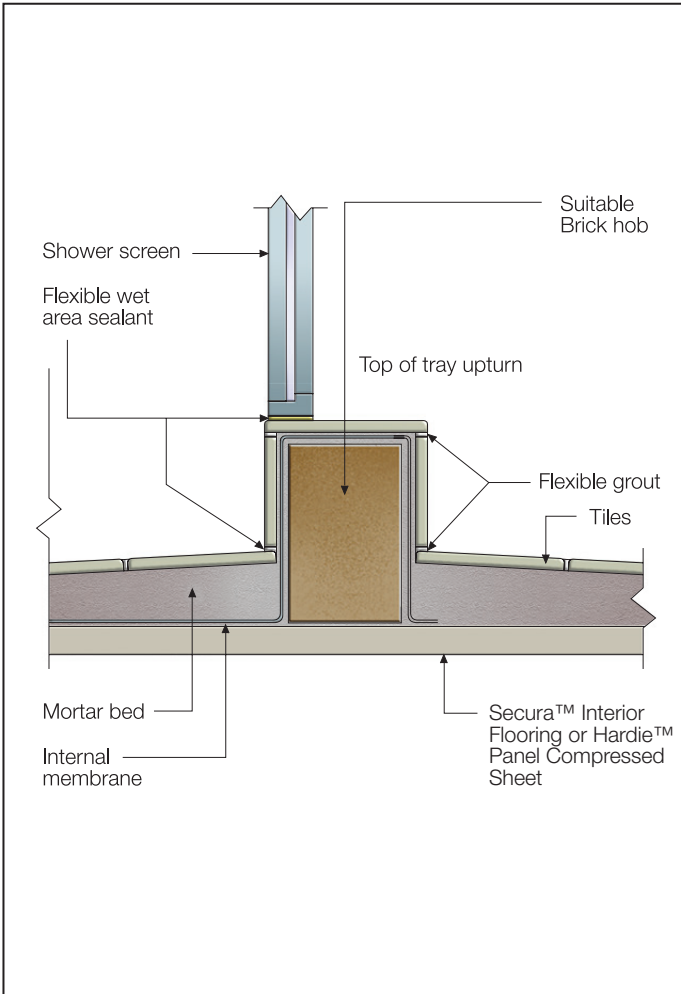

FIGURE 17 BRICK HOB - INTERNAL MEMBRANE

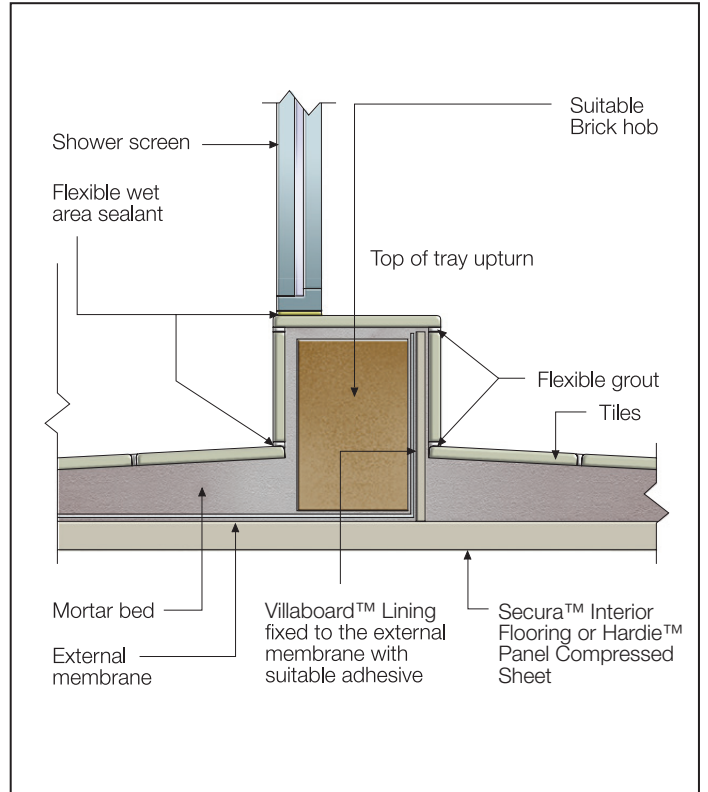

FIGURE 18 BRICK HOB - EXTERNAL MEMBRANE

Where the shower recess is hobless, the tray (either internal or external) must be terminated on an angle with its vertical leg projected a minimum of 5mm above the finished tile surface which is then covered by the shower screen base channel, see Figure 19.

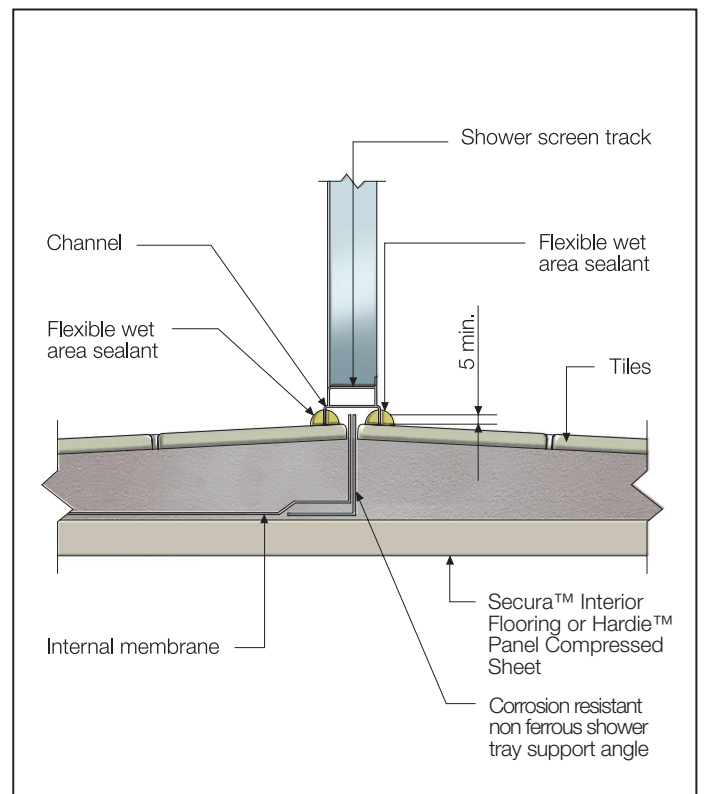

FIGURE 19 HOBLESS SHOWER

7 UNENCLOSED SHOWERS

Unenclosed showers are those where the shower fitting(s) are not contained within an enclosure.

Where the shower is unenclosed, you must have waterproof flooring for a distance extending 1500mm from the shower rose, projecting onto the floor, see Figure 20.

Water resistant walling (Villaboard™ Lining finished with tiles) must also extend 1500mm from the shower rose.

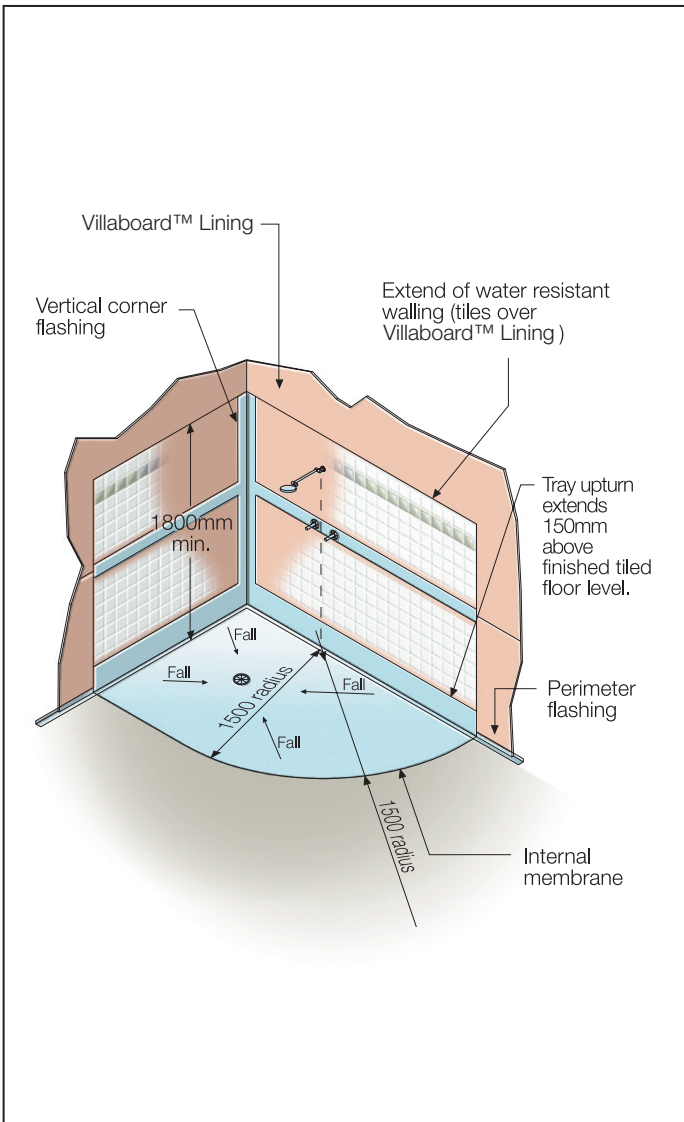

FIGURE 20 UNENCLOSED SHOWERS

Where a shower over a bath is not contained by a shower screen, you must waterproof the floor beyond the bath a distance extending 1500mm from the shower rose projected onto the floor, see Figure 21.

Although the perimeter flashing shown against wall and bath beyond 1500mm of the shower rose is not required, it is shown here because it is often installed for practical reasons.

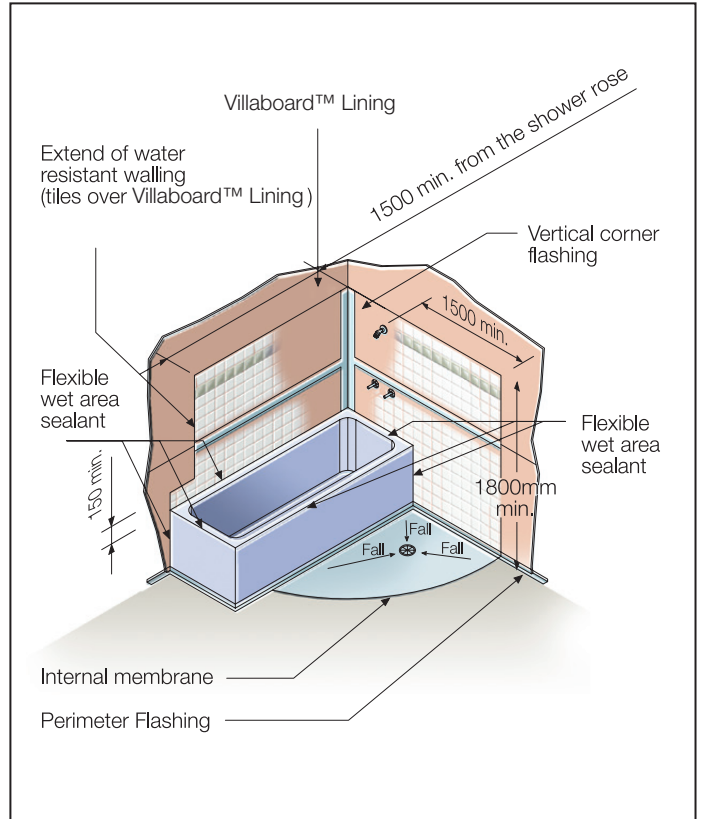

FIGURE 21 SHOWER OVER BATH - NO SHOWER SCREEN

The shower tray (either internal or external membrane) or the waterproofing beyond the bath must be terminated on an angle with its vertical leg finished flush with the tiled surface. The angle would normally be located in the floor tile jointing, see Figure 22.

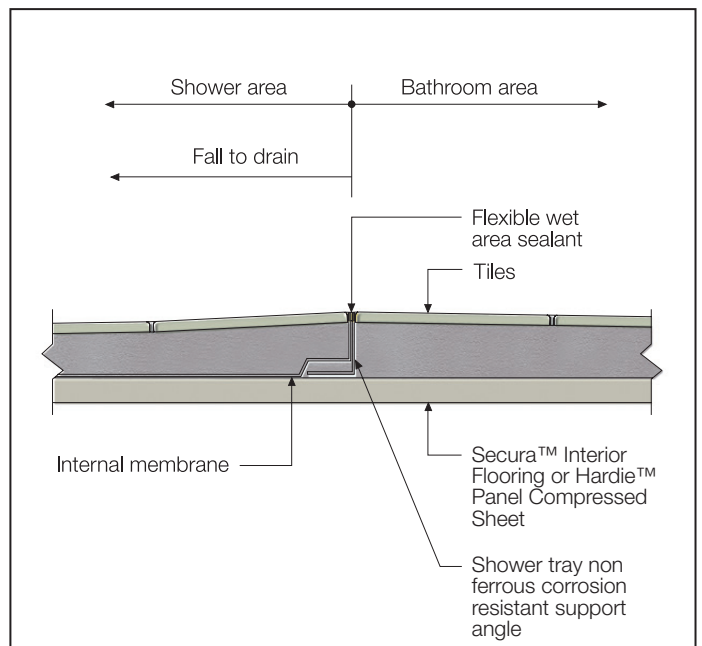

FIGURE 22 UNENCLOSED SHOWER - EDGE FINISHING DETAIL

NOTE

Internal membrane to shower area to extend 1500mm in horizontal distance from the furthest extension of the shower rose.

8 BATHS, BASINS AND TUBS

BATHS

Baths and spas must be sufficiently bedded to prevent cracking and must be recessed into the wall framing to allow the finished wall lining to pass down over the perimeter rim rebate. For the extent of sealing of junctions to a bath enclosure without a shower, see Figure 23.

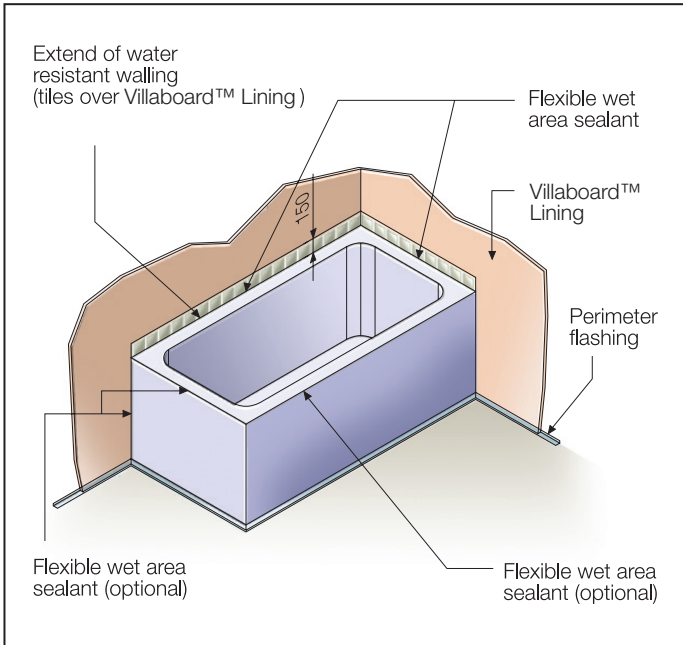

FIGURE 23 BATH WITHOUT SHOWER

NOTE

Where an enclosed or unenclosed shower is located over a bath, refer Figures 16 and 21 respectively for further information.

Where Villaboard™ Lining will be finished with tiles you must seal around the bath edge, see Figure 24.

BASINS AND TUBS

You must seal vessels such as hand basins and tubs that abut walls, see Figure 30.

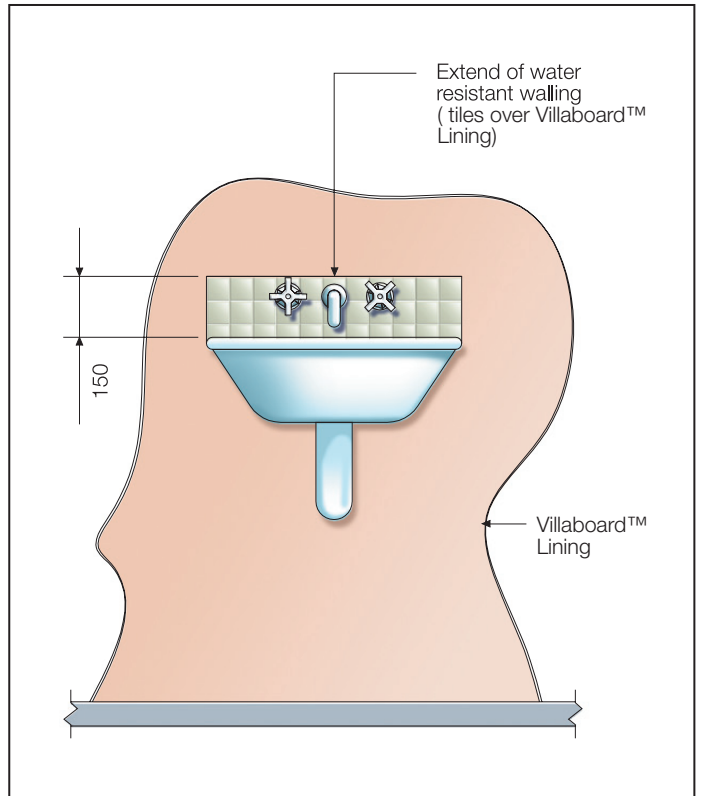

FIGURE 25 WATERPROOFING VESSELS ABUTTING WALLS

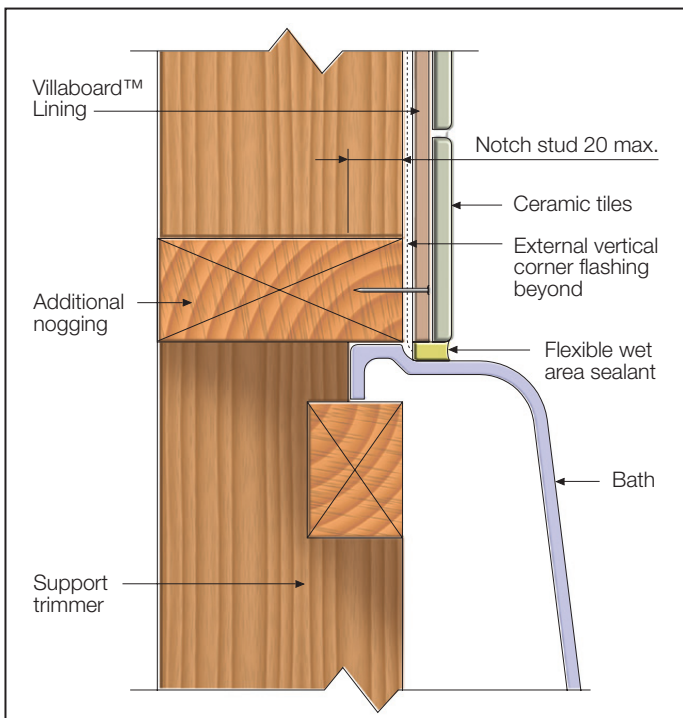

FIGURE 24A BATH EDGE DETAIL - VILLABOARD™ LINING TO BE FINISHED WITH TILES - TIMBER FRAME

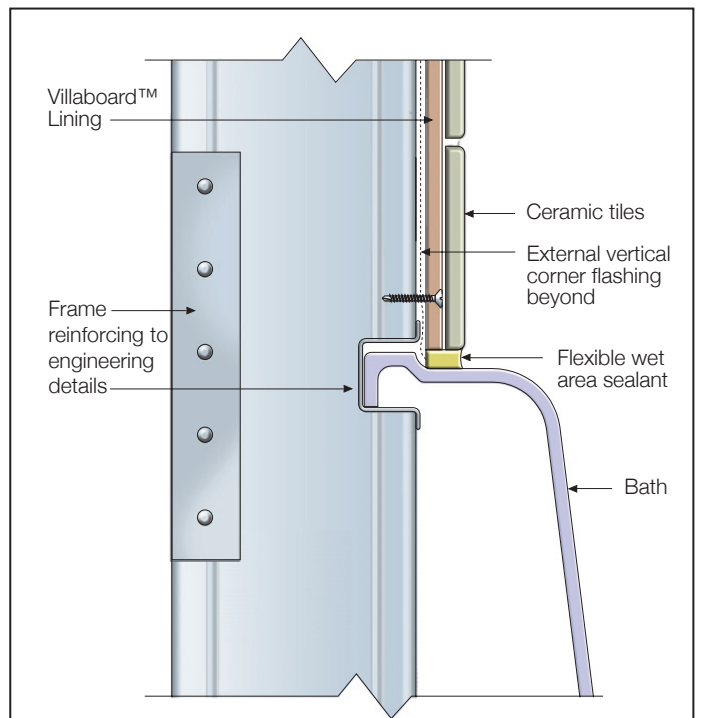

FIGURE 24B BATH EDGE DETAIL - VILLABOARD™ LINING TO BE FINISHED WITH TILES - STEEL FRAME

9 PENETRATIONS

WALL PENETRATIONS

Use a hole saw to form a neat cut for plumbing fixtures in Villaboard™ Lining. Taps should be adequately sealed to maintain the waterproof integrity of the wall, see Figure 26.

For information relating to taps penetrating fire or acoustically rated walls refer to the commercial or residential James Hardie fire and acoustically rated walls literature.

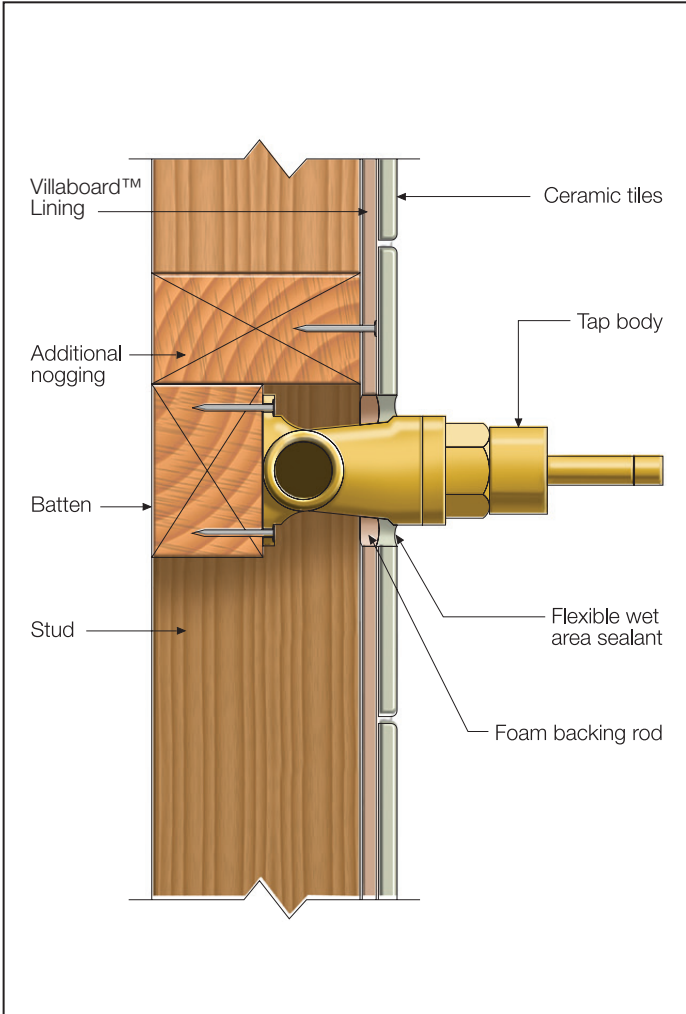

FIGURE 26 TAP PENETRATIONS TO SHOWER WALL

FLOOR PENETRATIONS

You must consider the provision of floor wastes and pipes penetrating the floor. When installing PVC pipes and fittings, a PVC flange must be bonded to the flooring and the waste pipe before grates and other fixtures are fitted. Perimeter holes should preferably be routed out so that the flange surface finishes flush with the sheet surface. This will provide a smooth surface for the turning in of the membrane into the body of the waste in shower recesses.

In practice however, this requirement is rarely carried out, because the flange is sealed to the normal surface, see Figure 27.

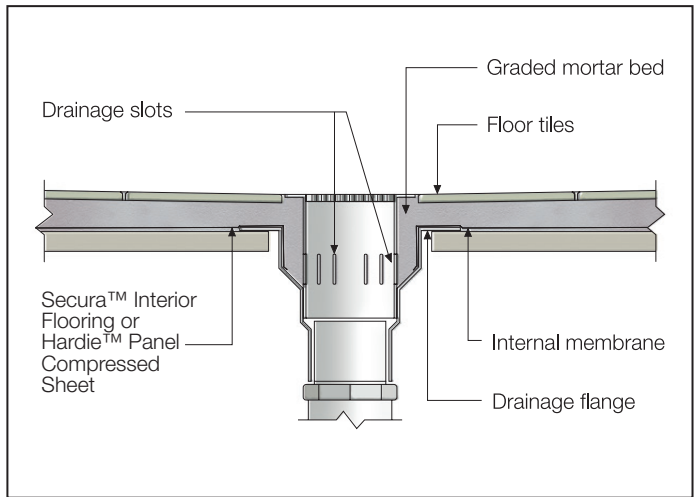

FIGURE 27 PRINCIPLE OF LEAK CONTROL WASTE

NOTES

1. Shower tray to be dressed over drainage flange.
2. Leak control drainage flange supports sanitary drainage plumbing.
3. Waste accepts water from both floor tile surface and shower tray surface.

10 APPENDIX A

TABLE 1

DESIGN AND INSTALLATION CRITERIA FOR WET AREA WATERPROOFING (Table 2.1 AS3740-2004)

VESSELS OR AREA WHERE THE FIXTURE IS INSTALLED	LEVEL OF RISK	DESIGN AND INSTALLATION CRITERIA			
		Floor	Walls	Junctions	Penetrations
Shower area	High	Waterproofed and drained.	Water-resistant	Waterproof	Waterproof*
Bathrooms	Medium	Concrete and compressed fibre cement sheet flooring. Water resistant †	N/A	Waterproof †	N/A
		Timber floors including particleboard plywood and other materials. Waterproof	N/A	Waterproof †	N/A
Areas adjacent to baths and spas § (applies to all rooms in which a bath or spa is installed).	Medium	Concrete and compressed fibre cement sheet flooring. Water resistant †	Water-resistant §	Waterproof	Horizontal surface waterproof* Vertical surface water-resistant.
		Timber floors including particleboard, plywood and other materials. Waterproof	Water-resistant §	Waterproof	Horizontal surface waterproof* Vertical surface water-resistant.
Walls adjoining other vessels (e.g. sink, basin or laundry tubs).	Low	N/A	Water-resistant	Waterproof	Horizontal surface waterproof* Vertical surface water-resistant.
Laundries and WCs	Low	Water resistant †	N/A	Water-resistant †	N/A
Bathrooms and laundries requiring a floor waste in accordance with Volume one of the BCA.	High	Waterproofed and drained.	N/A	Waterproof †	Waterproof where through the floor, otherwise, N/A.

LEGEND:

N/A = Not applicable

* Including mechanical fixings or fastenings through surface materials.

† Wall/floor junctions only.

‡ Where a floor waste is provided the floor shall be graded to the waste.

§ If a shower is included in a bath, include the requirements for shower area walls.

TABLE 2

GENERAL REQUIREMENTS FOR EXTENT OF APPLICATION (Table 4.1 AS3740-2004)

VESSELS OR AREA WHERE THE FIXTURE IS INSTALLED	REQUIREMENTS FOR ELEMENTS			
	Floors and horizontal surfaces	Walls	Wall junctions and joints	Penetrations
Shower area Enclosed and hobbled	Waterproof entire enclosed shower area, including hob (see Figure 4.3 (a), AS 3740)	Waterproof to 150mm min. above the shower floor finished tiled floor level or 25mm min. above the maximum retained water level and the remainder to be water resistant to a height of 1800mm min. from finished floor level.	Waterproof internal and external corners and horizontal joints within a minimum height of 1800mm above the floor level width of 40mm either side of junction.	Waterproof penetrations
Enclosed and hobless	Waterproof entire enclosed shower area including water stop.	Waterproof to 150mm min. above the shower finished tiled floor level and the remainder to be water resistant to a height of 1800mm min. from finished floor level.		
Enclosed and stepped down	Waterproof entire enclosed shower area including the stepdown.	Waterproof to 150mm min. above the shower finished tiled floor level or 25mm min. above the maximum retained water resistant to a height of 1800mm min. from finished floor level.		
Enclosed and preformed shower base	N/A	Water resistant to a height of 1800mm min. from finished floor level.	Waterproof internal and external corners and horizontal joints to a minimum height of 1800mm above the floor level with a minimum width of 40mm either side of junction.	Waterproof penetrations
Unenclosed	Waterproof entire shower area.	Waterproof to 150mm min. above the shower finished tiled floor level or 25mm min. above the maximum retained water level and the remainder to be water resistant to a height of 1800mm min. from finished floor level.	Waterproof internal and external corners and horizontal joints to a minimum height of 1800mm above the floor level with a minimum width of 40mm either side of junction.	Waterproof penetrations
Areas outside the shower area for concrete and compressed fibre cement sheet flooring.	Water resistant to entire floor.	N/A	Waterproof all wall to floor junctions, where a flashing is used the horizontal leg shall be a minimum of 50mm.	N/A
Areas outside the shower area for timber floors including particleboard, plywood and other flooring materials.	Waterproof entire floor.	N/A	Waterproof all wall to floor junctions, where a flashing is used the horizontal leg shall be a minimum of 50mm.	N/A
Areas adjacent to baths and spas *† for concrete and compressed fibre cement sheet flooring.	Water resistant to entire floor.	Water resistant to a height of 150mm min. above vessel and exposed surfaces below vessel lip to floor level*	Seal edges for extent of vessel and junction of bath enclosure with floor. Where the lip of the bath is supported by a horizontal surface this area shall be waterproof for showers over bath and water resistant for all other cases.	Waterproof tap and spout penetrations where they occur in a horizontal surface.
Areas adjacent to baths and spas *† for timber floors including particleboard, plywood and other flooring materials	Waterproof entire floor	Water resistant to a height of 150mm min. above vessel and exposed surfaces below vessel lip to floor level*	Seal edges for extent of vessel and junction of bath enclosure with floor. Where the lip of the bath is supported by a horizontal surface this area shall be waterproof for showers over bath and water resistant for all other cases.	Waterproof tap and spout penetrations where they occur in a horizontal surface.

TABLE 2 CONTINUED

GENERAL REQUIREMENTS FOR EXTENT OF APPLICATION (Table 4.1 AS3740)				
VESSELS OR AREA WHERE THE FIXTURE IS INSTALLED	REQUIREMENTS FOR ELEMENTS			
	Floor and horizontal surfaces	Walls	Wall junctions and joints	Penetrations
Insert baths	N/A for floor under the bath. Waterproof entire shelf area, incorporating a waterstop under the bath lip and project a minimum of 5mm above the tile surface.	N/A for wall under the bath. Waterproof to 150mm min. above the lip of the bath*.	N/A for wall under the bath*.	Waterproof tap and spout penetrations where they occur in a horizontal surface.
Walls adjoining other vessels (e.g. sink, basin or laundry tub)	N/A	Water resistant to a height of 150mm min. above vessel if the vessel is within 75mm min. of the wall	Where the vessel is fixed to a wall, seal edges for extent of vessel.	Waterproof tap and spout penetrations where they occur in a horizontal surface.
Laundries and WCs	Water resistant to entire floor.	Seal all wall to floor junctions with a skirting or flashing to 25mm min. above the finished floor level, sealed to the floor.	Waterproof all wall to floor junctions, where a flashing is used the horizontal leg shall be a minimum of 50mm.	N/A
Bathrooms and laundries requiring a floor waste in accordance with Volume one of the BCA.	Waterproof and drain entire floor.	N/A	Seal all wall to floor junctions with a skirting or flashing to 25mm min. above the finished floor level, sealed to the floor.	Waterproof penetrations where they occur through the floor.

LEGEND:

N/A = Not applicable

* If a shower is included in a bath refer to the requirements for shower area walls and penetrations.

† Does not apply to joinery fittings such as vanities.





**For information and advice
call 13 11 03 | [jameshardie.com.au](https://www.jameshardie.com.au)**

Australia March 2022



© 2022 James Hardie Australia Pty Ltd ABN 12 084 635 558
™ and ® denote a trademark or registered mark owned by James Hardie Technology Limited.