

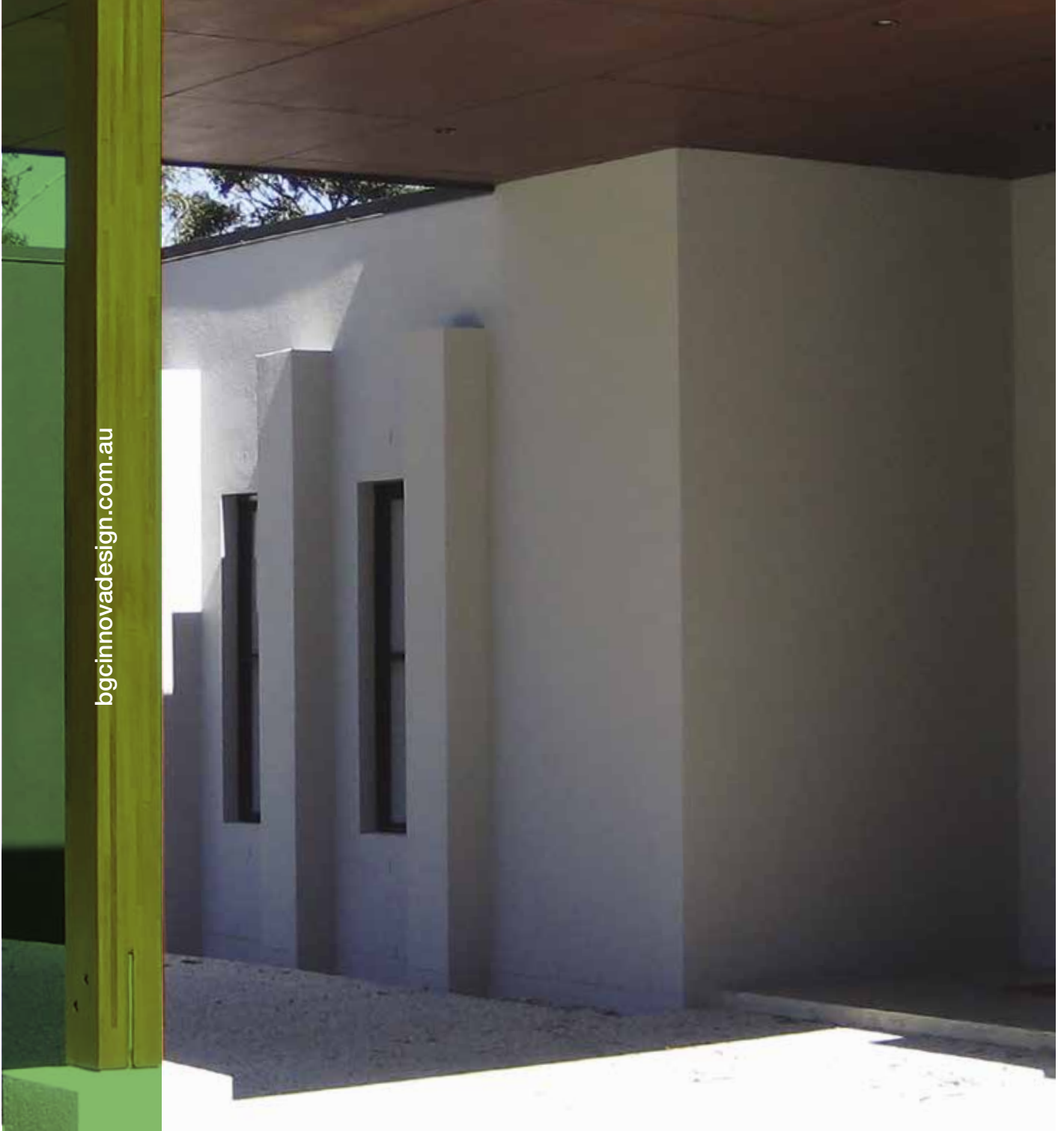

DURASCAPE™
FACADE SYSTEM



bgcinnovadesign.com.au

BGC's stunning InnovaTM range of facade, lining and flooring products will move you to reassess your concept of excellence in facades and flooring systems. Durable and dynamic, fresh and contemporary, InnovaTM is already turning industry heads. Now let the InnovaTM range of cladding and flooring products breathe new life into your creativity and project specification.

Contents

- 7 // Applications
- 7 // Advantages
- 7 // Energy Efficiency Considerations
- 7 // Product Information
- 7 // Fire Resistance
- 7 // Durability
- 7 // Thermal Conductivity
- 7 // Sheet Sizes and Weight
- 7 // Sheet Tolerances
- 8 // Cutting and Drilling
- 8 // Handling and Storage
- 8 // Coastal Areas
- 9 // Accessories available from BGC
- 9 // Fasteners
- 10 // Construction Details
- 11-21 // Installation Details
- 22 // Thermal Breaks – Steel Frame
- 23 // Bushfire and Boundary Wall Areas – Timber Frame
- 24 // Painting
- 24 // Maintenance
- 24 // Deemed to Comply
- 24 // Warranty

DURASCAPE™ FACADE SYSTEM

Durascape™ is a 9mm-thick base sheet. Excellent for covering large areas, its 5mm wide shiplap joint gives the sheet a subtle vertical shadow line.

To create an appealingly ‘rendered’ look, try finishing Durascape™ onsite with a roll-on textured paint.

Durascape™ Facade System

- / Lightweight and durable
- / Ideal for single-storey and medium height installations where you want large panels
- / Quick installation – no need for taped and filled joints
- / Panels unaffected by termites, air, steam, salt and sunlight
- / Can be finished in a range of decorative coatings

Specify Durascape™ with confidence



bgcinnoovadesign.com.au/fire-resistant



Fibre Cement



Innova™ deemed to comply external facade systems.

- / Compressed Fibre Cement range
- / Architectural designed weatherboard range
- / Grooved and profiled cladding range

BGC's products have superior fire performance against four key indicies.



Ignition index = 0

Fibre cement does not ignite



Spread of flame index = 0

There is no spread of fire with fibre cement



Heat evolved index = 0

Heat does not evolve from fibre cement



Smoke developed index = 0-1

Smoke is not emitted from fibre cement



Up to **BAL 40**
as per AS3959:2009



Tested in Australia by accredited Australian authorities **CSIRO** and **Exova Warrington**

Case Study 01.



Project: The Gap Location: Queensland
Builder: HG Homes



Applications

Durascape™ is a strong and durable base sheet which has a subtle shiplap vertical joint that is suitable for finishing with a range of decorative coatings.

Durascape™ is suitable for low to medium rise buildings and can be used on both timber and steel framed buildings. It is also ideal for renovations and alterations to existing dwellings.

Advantages

- / Gives a subtle 5mm vertical shadow line
- / Has a shiplap join for ease of installation
- / Is lightweight and durable
- / Quick to install because it eliminates the need for taped and filled joints
- / Panels are not affected by termites, air, steam, salt or sunlight

Energy Efficiency Considerations

Energy efficiency requirements have been introduced into the National Construction Code (NCC) for both commercial and residential buildings. Thermal heat transfer into and out of the building envelope will affect the running cost of the building and careful consideration of thermal heat transfer needs to be addressed by the architects, engineers and building designers. Thermal bridging through steel framing will diminish the total R-Value; thermal conductance of the wall. Thermal breaks are required for steel framed buildings and should be installed between the steel frame and the Durascape™ panels. Thermal break tapes should have a minimum R-Value of 0.2.

Product Information

Durascape™ panels are manufactured from Portland cement, finely ground silica, cellulose fibres and water. Panels are cured in a high-pressure steam autoclave to create a durable, dimensionally stable product.

Durascape™ panels are manufactured to the Australian / New Zealand Standard AS/NZS 2908.2-2000 Cellulose-Cement Products, Part 2: Flat sheets and Durascape™ is classified as Type A-Category 2.

Fire Resistance

BGC Fibre Cement products have been tested in accordance with Australian Standard AS1530.3.

These tests deemed the following Early Fire Hazard Indices:

- / Ignition Index 0
- / Spread of Flame Index 0
- / Heat Evolved Index 0
- / Smoke Developed Index 0-1

Durability

Durascape™ physical properties make it a very durable product.

- / Durascape™ panels are immune to permanent water damage in both short and long-term exposure.
- / Durascape™ panels will not rot or burn and are unaffected by termites, air, steam, salt and sunlight.
- / Durascape™ panels are not adversely affected over a temperature range of 0°C to 95°C.

A Vapour permeable moisture barrier must be installed in accordance with the AS/NZS 4200.2 – ‘Pliable building membranes and underlays – Installation’ and the vapour permeable moisture barriers manufacturer’s guidelines. The vapour permeable moisture barrier should have the following properties:

- / Vapour barrier – low or medium
- / Water barrier – high

A Vapour permeable moisture barrier is used to prevent moisture ingress by acting as a drainage plane whilst enabling water vapour build up from inside the frame to escape.

Thermal Conductivity

Durascape™ panels have relatively low thermal conductivity: thermal conductivity. At Equilibrium Moisture content the approximate thermal conductivity of Durascape™ is;- 0.55 W/m°C.

Weather Resistance / Freeze Thaw

Durascape™ conforms to the National Construction Code (NCC) requirements for external wall applications. Durascape™ facade system has been tested to AS/NZS 4284 Testing of Building Facades.

Durascape™ subject to freeze/thaw conditions must be painted. Durascape™ should not be used in situations where it will be in direct contact with snow or ice for prolonged periods.

Sheet Sizes and Weight - Table 1

THICKNESS mm	WEIGHT kg/m ²	WIDTH mm	LENGTH mm	
			2450	3000
9	13.5	900	✓	✓
		1200	✓	✓

Weight is based on Equilibrium Moisture Content

Sheet Tolerances

Durascape™ complies with the requirements of AS 2908.2.

DURASCAPE™

FACADE SYSTEM

Health and Safety

Durascape™ is manufactured from cellulose fibre, finely ground sand, Portland cement and additives. As manufactured, the product will not release airborne dust, but during drilling, cutting and sanding operations cellulose fibres, silica and calcium silicate dust may be released.

Breathing in fine silica dust is hazardous and prolonged exposure (usually over several years) may cause bronchitis, silicosis or cancer.

Avoid Inhaling Dust

When cutting sheets, work in a well ventilated area and use the methods recommended in this literature to minimise dust generation. If using power tools wear an approved (P1 or P2) dust mask and safety glasses.

These precautions are not necessary when stacking, unloading or handling fibre cement products.

For further information or a Material Safety Data Sheet contact the nearest BGC Sales Office or go to www.bgcinnovadesign.com.au

Cutting and Drilling

The most suitable cutting methods are:

/ DURABLADE

180mm Diameter.
This unique cutting blade is ideal for cutting fibre cement. Can be fitted to a 185mm circular saw, ie Makita or similar. Please ensure safe working practices when using.



/ NOTCHING

Notches can be made by cutting the two sides of the notch. Score along the back edge then snap upwards to remove the notch.

/ DRILLING

Use normal high-speed masonry drill bits. Do not use the drill's hammer function. For small round holes, the use of a hole-saw is recommended. For small rectangular or circular penetrations, drill a series of small holes around the perimeter of the cut out. Tap out the waste piece from the sheet face while supporting the underside of the opening to avoid damage. Clean rough edges with a rasp.

Large rectangular openings are formed by deeply scoring the perimeter of the opening. Next, form a hole in the centre of the opening (refer method above) then saw cut from the hole to the corners of the opening. Snap out the four triangular segments. Clean rough edges with a rasp.

Handling and Storage

Durascape™ must be stacked flat, up off the ground and supported on equally spaced (max 400mm) level gluts.

Care should be taken to avoid damage to the ends, edges and surfaces.

Sheets must be kept dry. When stored outdoors it must be protected from the weather. Sheets must be dry prior to fixing, jointing or finishing.

EXTRA CARE MUST BE TAKEN AT THE SHEET EDGES TO PREVENT CRACKING OF THE SHIPLAP JOIN.

Coastal Areas

The durability of galvanised nails and screws used for exterior cladding in coastal or similar corrosive environments can be as low as 10 years.

For this reason BGC recommend the use of stainless steel fasteners within 1km of the coast or other large expanses of salt water.

Durascape™ accessories available from BGC

EPDM FOAM GASKET (Used to prevent moisture ingress at sheet joints).	25m	BGC PRODUCT CODE 845	
ALUMINIUM INTERNAL CORNER	3000mm	BGC PRODUCT CODE INTCNR12	
ALUMINIUM EXTERNAL CORNER	3000mm	BGC PRODUCT CODE EXTCNR12	
ALUMINIUM HORIZONTAL FLASHING	3000mm	BGC PRODUCT CODE HORIZ9	

Fasteners - Supplied by others

Durascape™ to timber frame

2.8 x 30mm Fibre Cement Nail
(minimum Class 3 corrosion resistant)



2.8 x 40mm Gun Nail
(minimum Class 3 corrosion resistant)



50mm ND Brads
(suitable up to N3 Wind Zone only)



- / Do not overdrive gun nails. Gun nails should be round head nails, and driven either slightly proud of the surface, and hand finished or driven flush with the face.
- / Screws should be countersunk 2mm and filled with BGC Exterior Finishing Compound or epoxy sealer such as Megapoxy P1, Hilti CA125 or Hilti CA273 and sanded flush to provide a flat surface for finish coating.
- / Nails must be driven flush to the panel surface.

Fasteners - Supplied by others

Durascape™ to steel frame

To Steel – 0.75BMT
No 8 x 30mm Countersunk Self Drilling
(minimum Class 3 corrosion resistant)



To Steel - 0.8-1.6BMT
8 x 40mm Wingtek Self Embedding Head Screw
(minimum Class 3 corrosion resistant)



PRE COUNTERSINK

When using screws to fasten Durascape™, pre-countersinking is suggested so that the fastener is 2mm under the sheet surface for filling with epoxy filler and BGC Exterior Finishing Compounds.

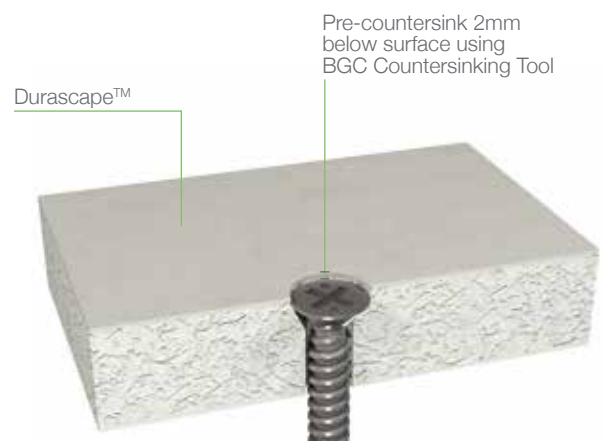

Construction Details

Framing

Durascape™ panels can be installed to both timber and lightweight steel frames.

Ensure that the frame is square and work from a central datum line. The frame must be straight and true to provide a flush face to receive the panels.

BGC recommend a maximum tolerance of 3mm-4mm in any 3000mm length of frame.

Durascape™ will not straighten excessively warped or distorted frames and any warping may still be visible after Durascape™ is applied. Warped framing will require remedial action.



Figure 1
Frame Straightness

Timber Frames

Use of a timber frame must be in accordance with AS1684 – Residential timber-framed construction and the framing manufacturers' specifications.

Use only seasoned timber. Do not use unseasoned timber as it is prone to shrinkage and can cause sheets and frames to move and twist.

“Timber used for house construction must have the level of durability appropriate for the relevant climate and expected service life conditions including exposure to insect attacks or to moisture which could cause decay” – Reference AS 1684.2

THE FRAMING WIDTH AT SHEET JOINTS MUST BE A MINIMUM OF 45MM. THE INTERMEDIATE SUPPORT STUDS SHOULD BE A MINIMUM WIDTH OF 35MM.

Lightweight Steel Frames

Use of steel frame must be in accordance with AS3623 – Domestic metal framing and the framing manufacturers' specifications.

Framing members must have a Base Metal Thickness (BMT) between 0.50 to 1.6mm. The steel framing must have the appropriate level of durability required to prevent corrosion.

Maximum Stud and Fastener Spacing - Table 2

Wind Classification AS4055	General Areas of Walls		Within 1200mm of Buildings Edges	
	Stud Spacing (mm)	Fastener Spacing (mm)	Stud Spacing (mm)	Fastener Spacing (mm)
All Fasteners except Brad Nails				
N1, N2, N3, N4	600	200	600	200
N5	400	200	300	150
N6	400	150	300	125
C1, C2	600	200	600	200
C3	400	200	300	150
C4	400	150	300	125
50mm ND Brad Nails				
N1, N2, N3	400	75	400	75

Installation Details

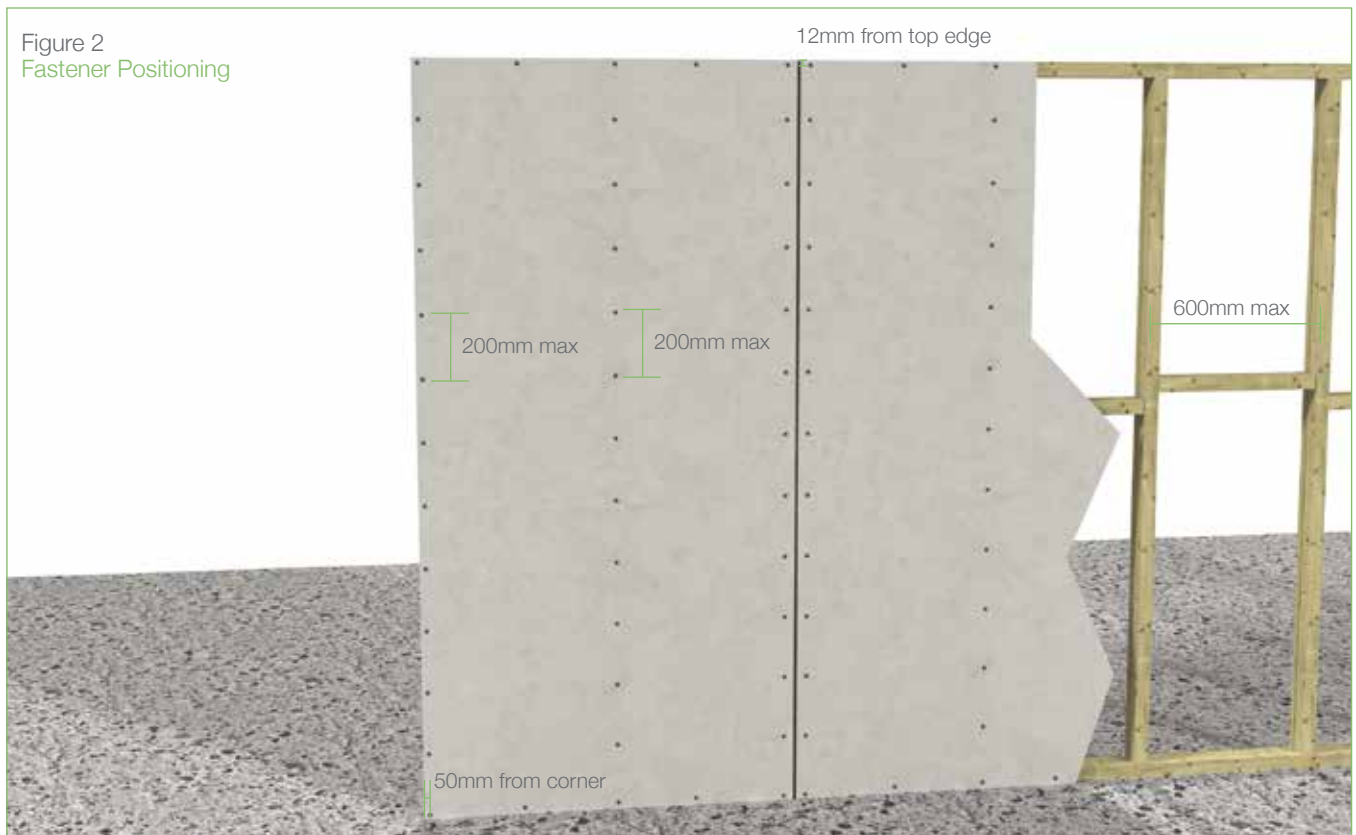

Durascpae™ panels should be installed vertically with all sheet edges fully supported. The centre joints must coincide with the

centre lines of the framing member and all sheets should be installed in one direction.

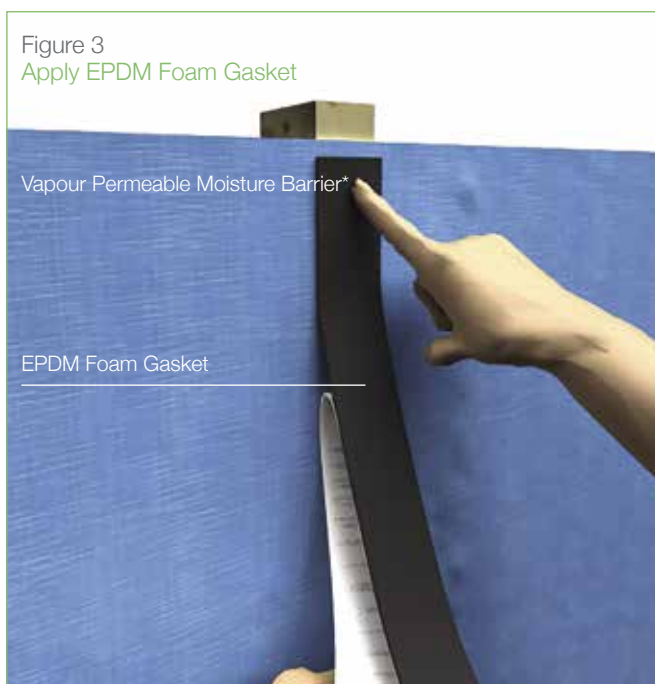

At every vertical joint, fix a continuous strip of EPDM Foam Gasket to the vapour permeable moisture barrier along the stud. This assists to prevent moisture ingress at the sheet joints.

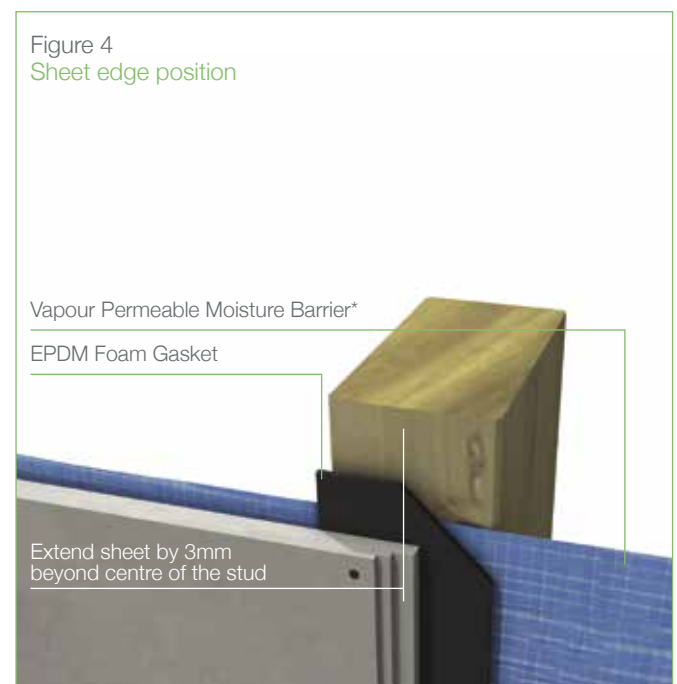

Position the underlap sheet on every stud 3mm past the centre of the stud to ensure the fasteners fixed at the edge of the sheet have adequate distance into the stud.

Installation Details

As detailed on P9, there are several different fasteners that can be used to fix Durascape™ panels.

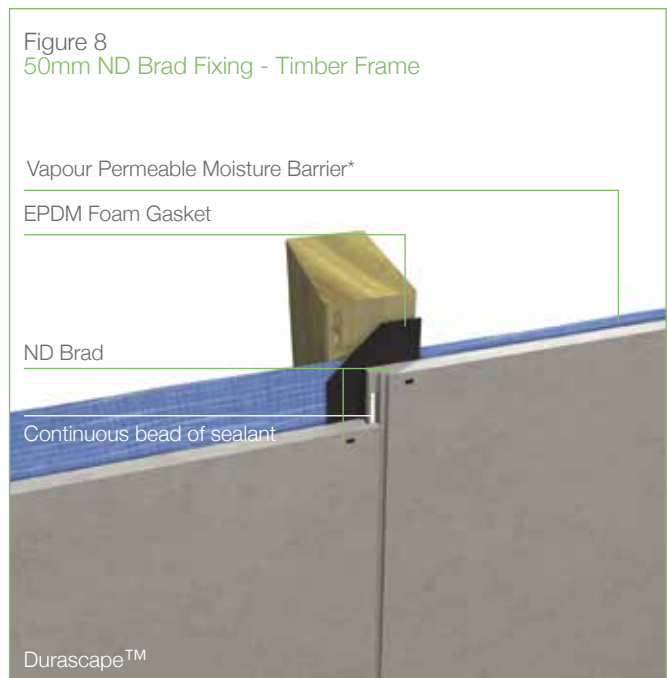
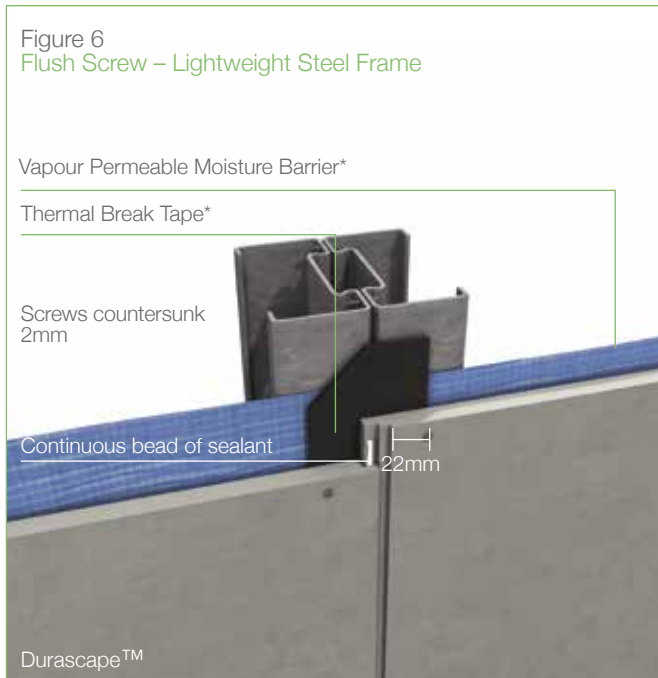
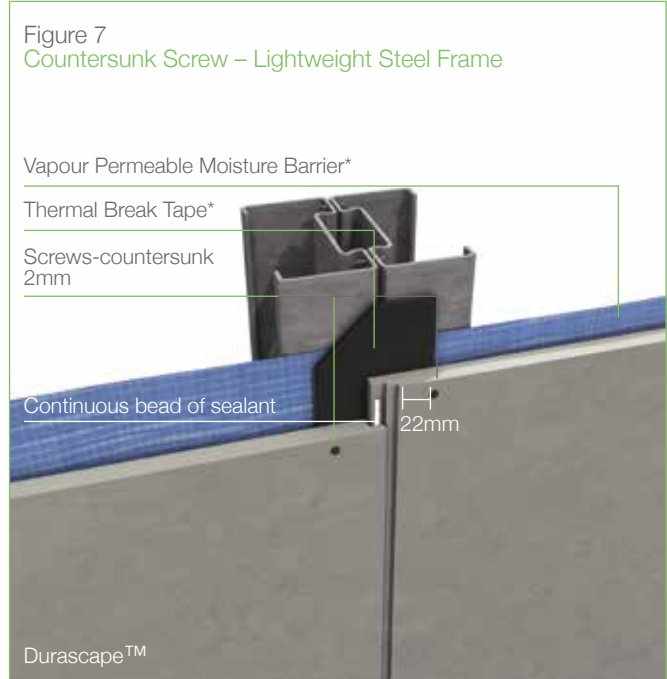
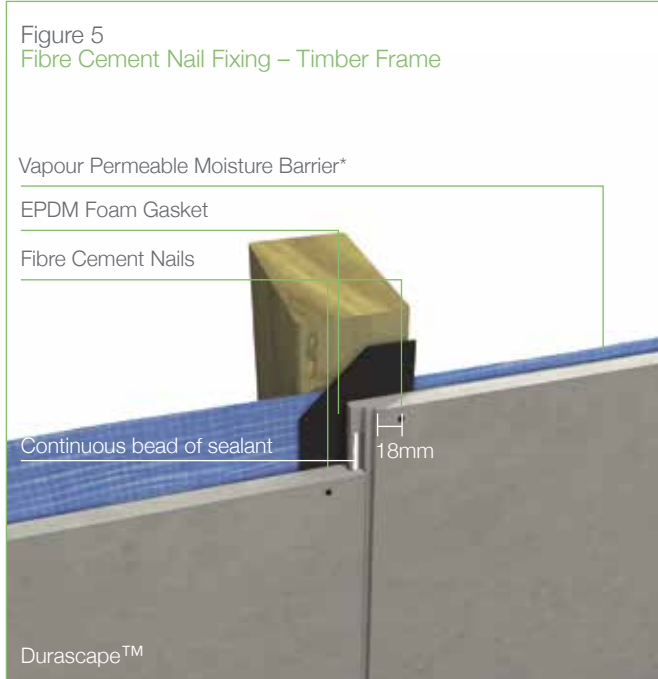

Suitable up to N3 wind zones only.

Installation Details

To fix the first sheet, set in place ensuring the required edge distances are maintained.

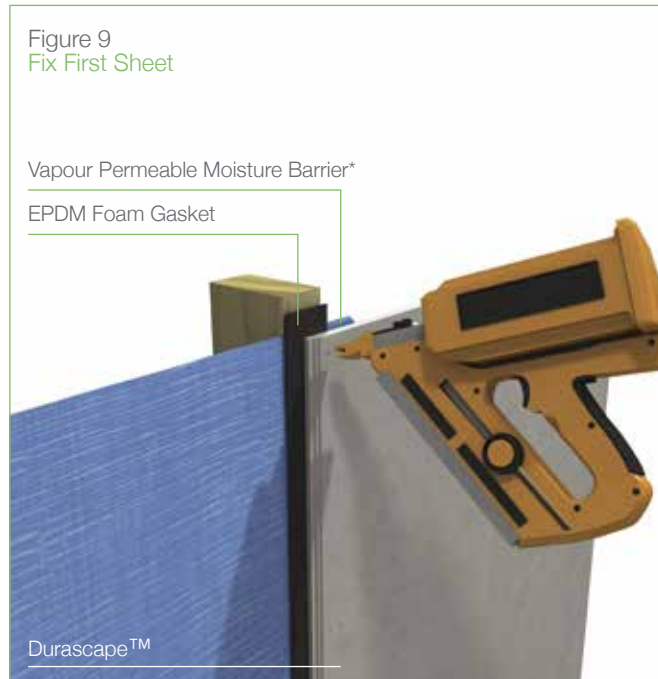

Apply a continuous 4mm bead of sealant to the edge of the shiplap joint.

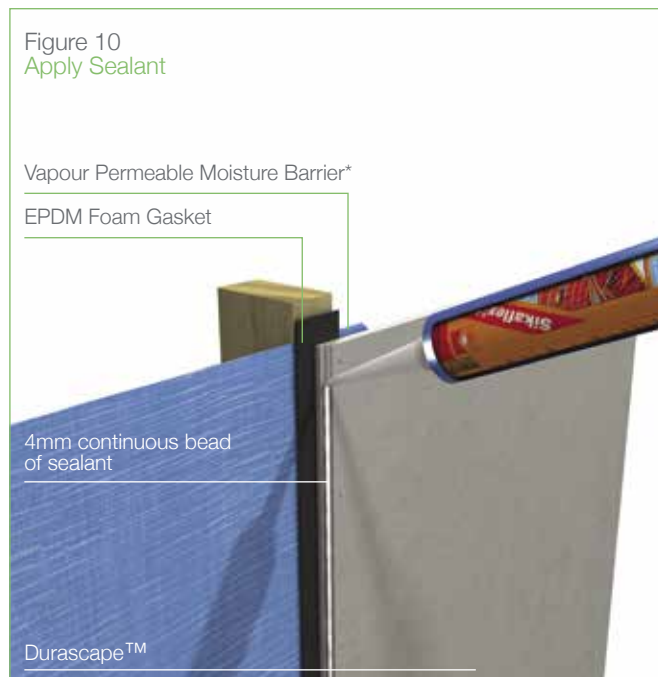

Once both sheets are fixed, check the joint for gaps and fill with additional sealant if required.

Installation Details

The architectural intent and details of buildings vary from one designer to the next, and the variety of facade details would be impossible to catalogue.

The designer should not digress from the specification set out in this manual.

The detail diagrams following are intended to assist the designer in achieving a high quality weather resistant Durascape™ installation.

Figure 12
Slab Edge

Vapour Permeable Moisture Barrier*

Durascape™

Damp Course*

150mm clearance from earth,
50mm clearance from finished
surface e.g. paving/concrete.

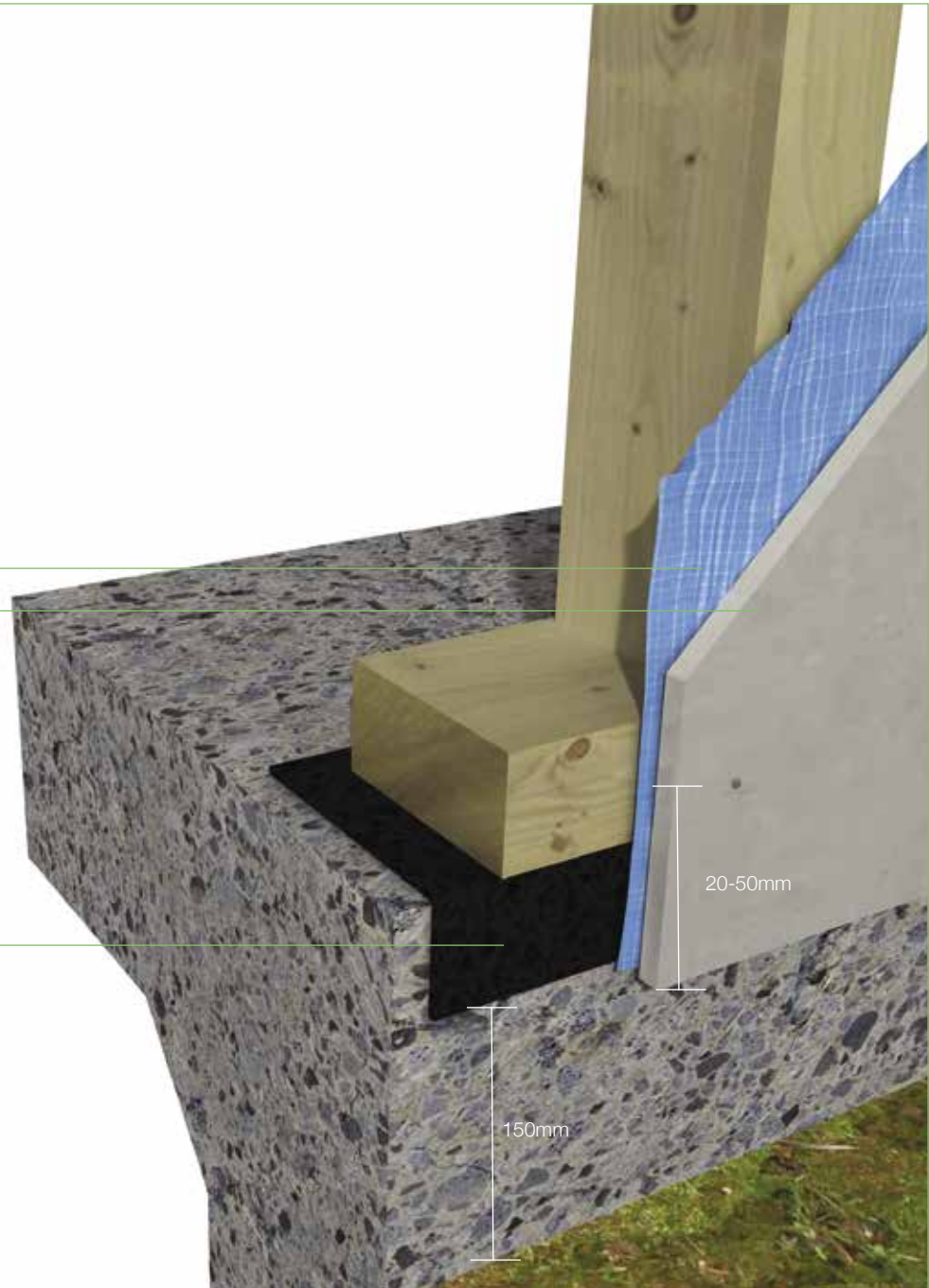

Installation Details

Figure 13
External Corner – Sealant Option

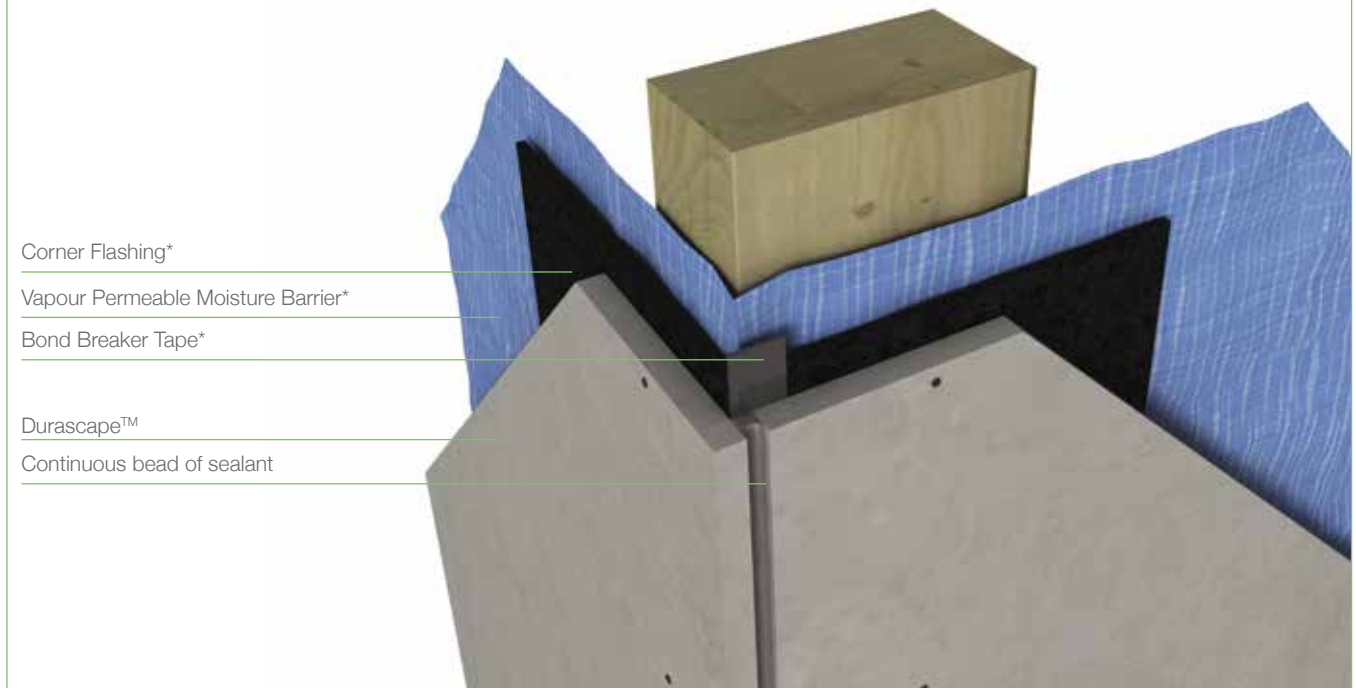
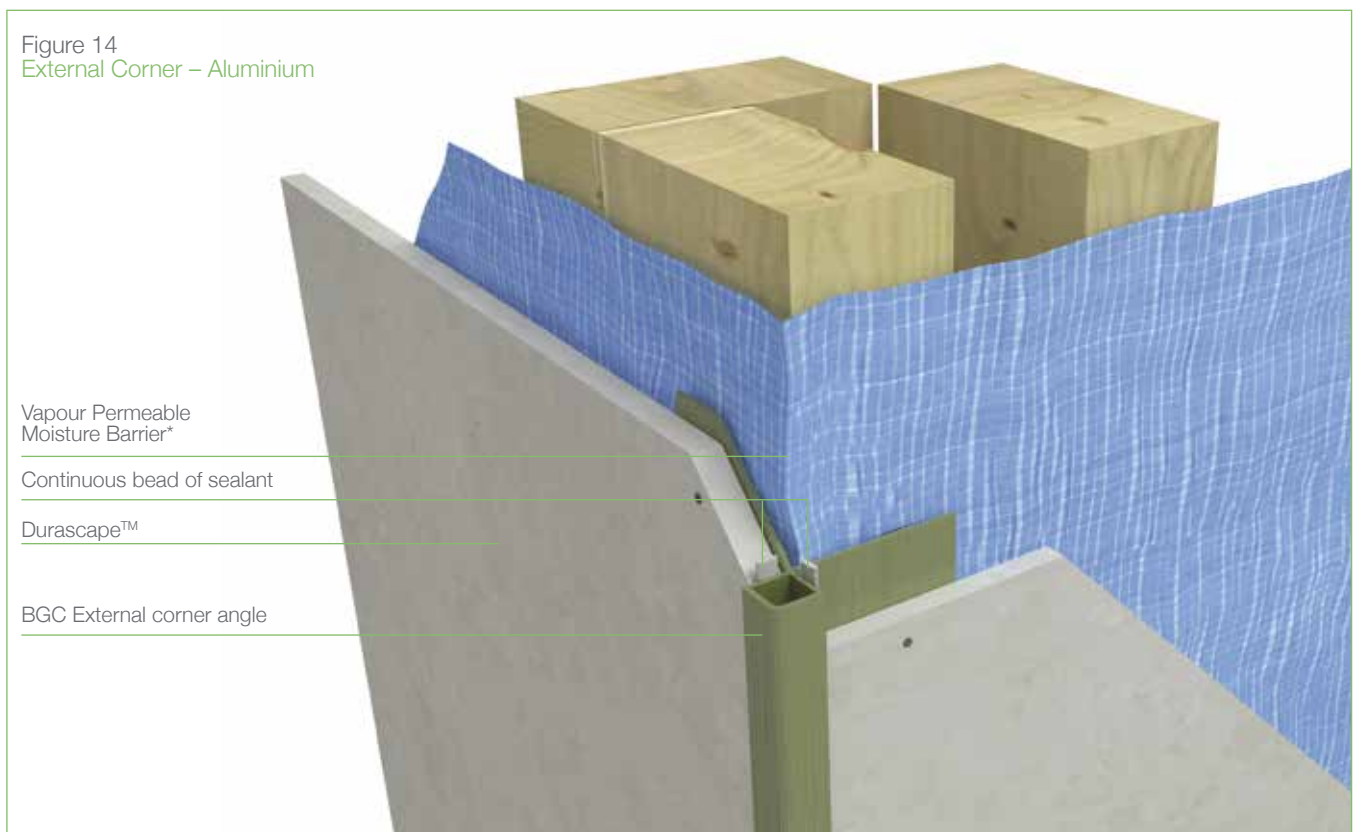

Figure 14
External Corner – Aluminium



Installation Details

Figure 15
Internal Corner – Sealant Option

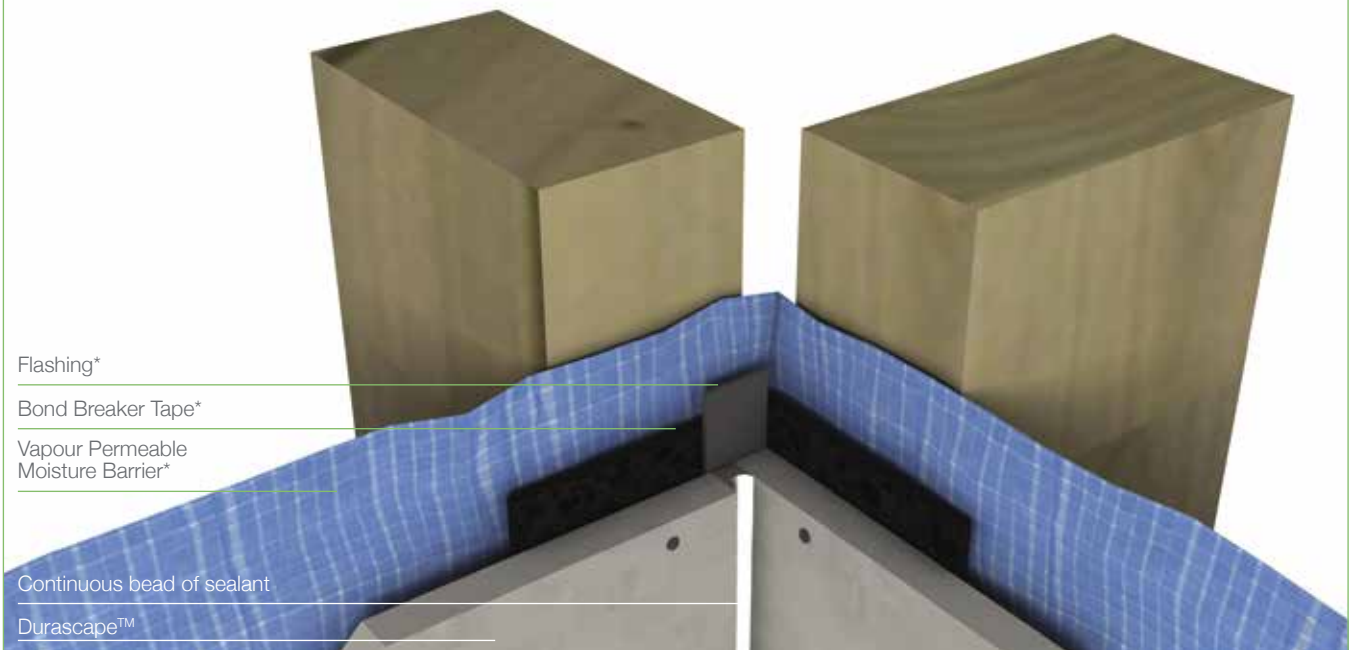
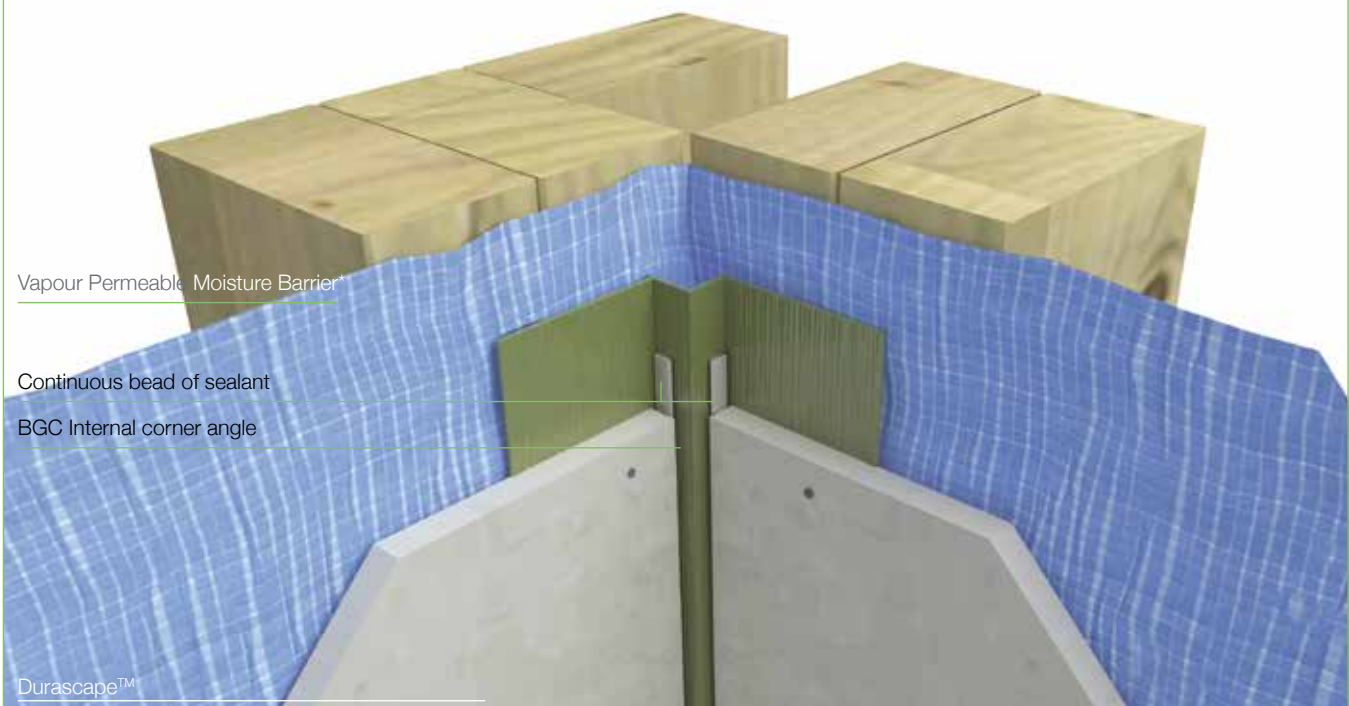

Figure 16
Internal Corner – Aluminium



Installation Details

Figure 17
Window Head

Durascape™

Flashing tape*

Continuous bead of sealant

Vapour Permeable Moisture Barrier*

Optional trim*

Aluminium window head flashing*

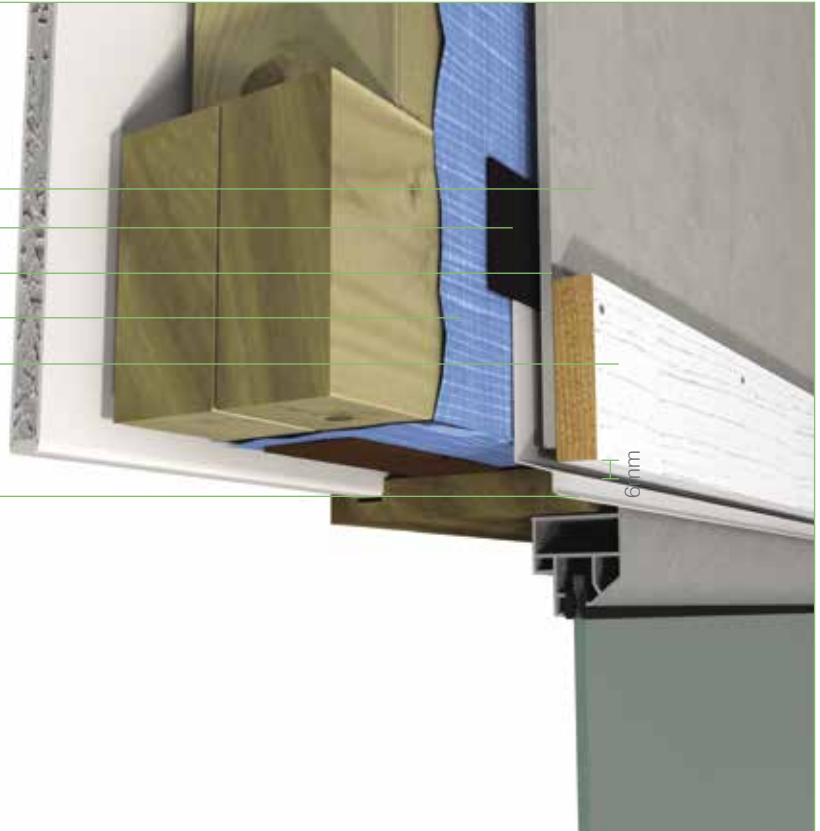

Figure 18
Window Sill

Continuous bead of sealant

Flashing*

Vapour Permeable Moisture Barrier*

Durascape™

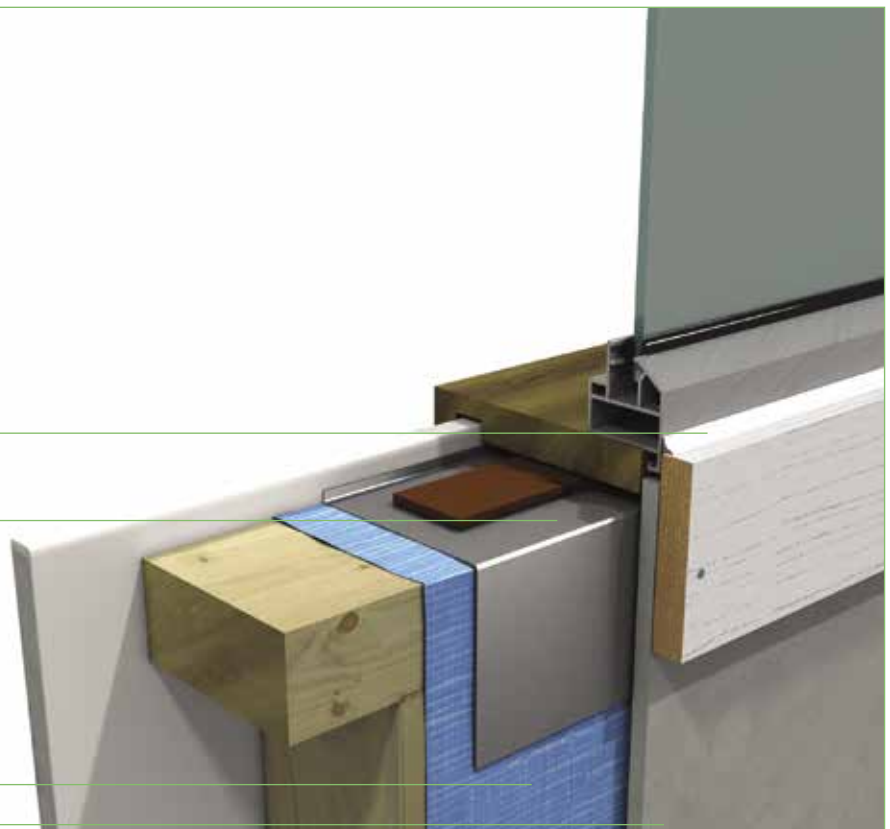

Installation Details

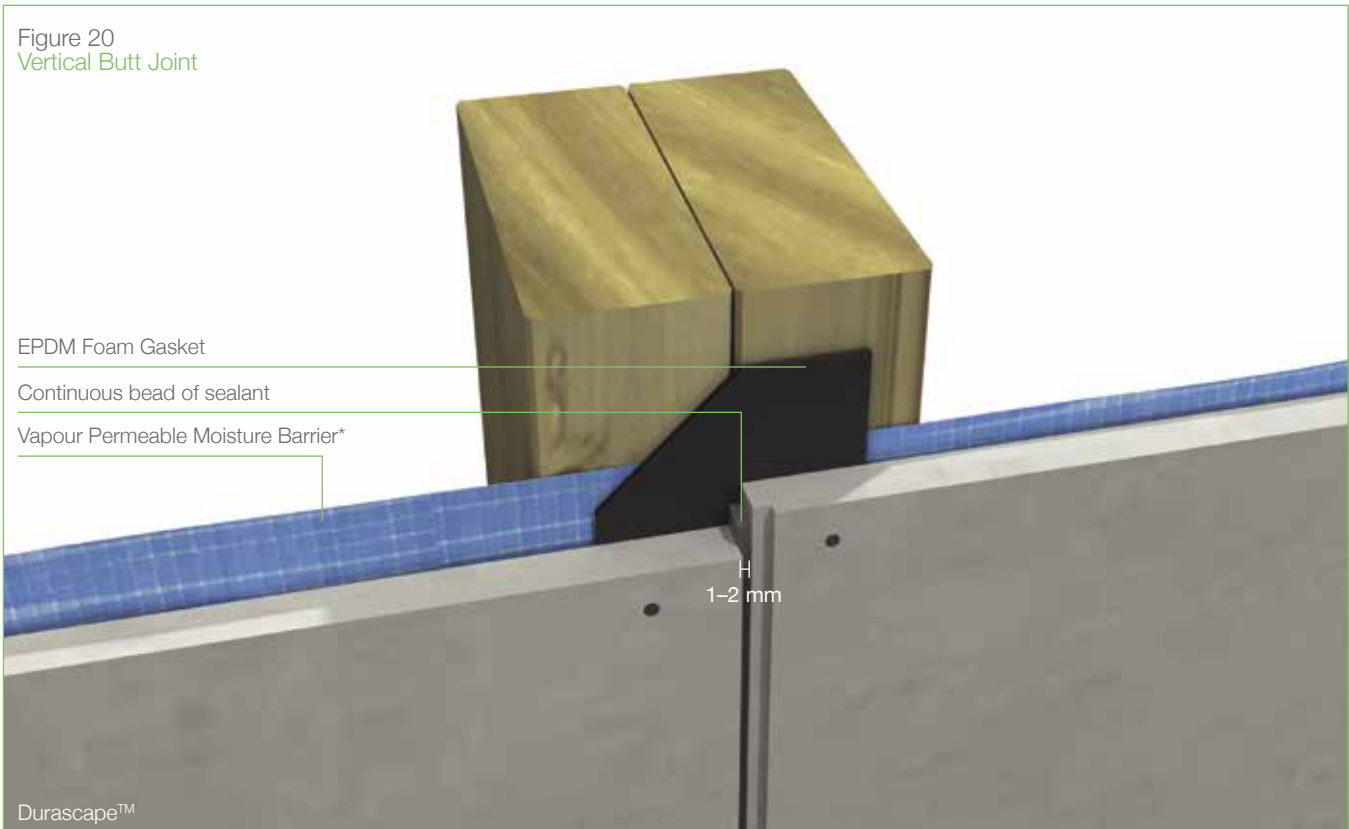
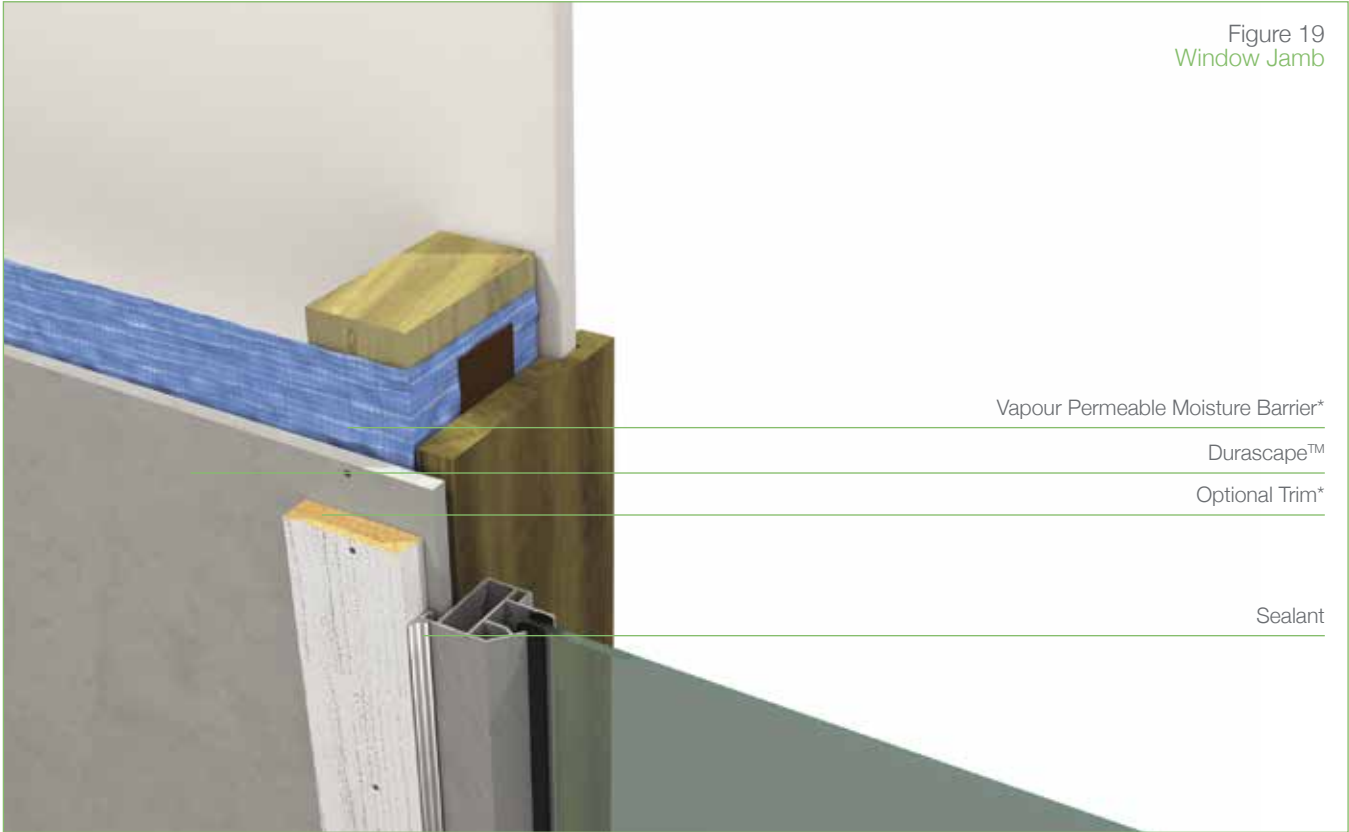

Installation Details

Figure 21
Lower Floor Junction

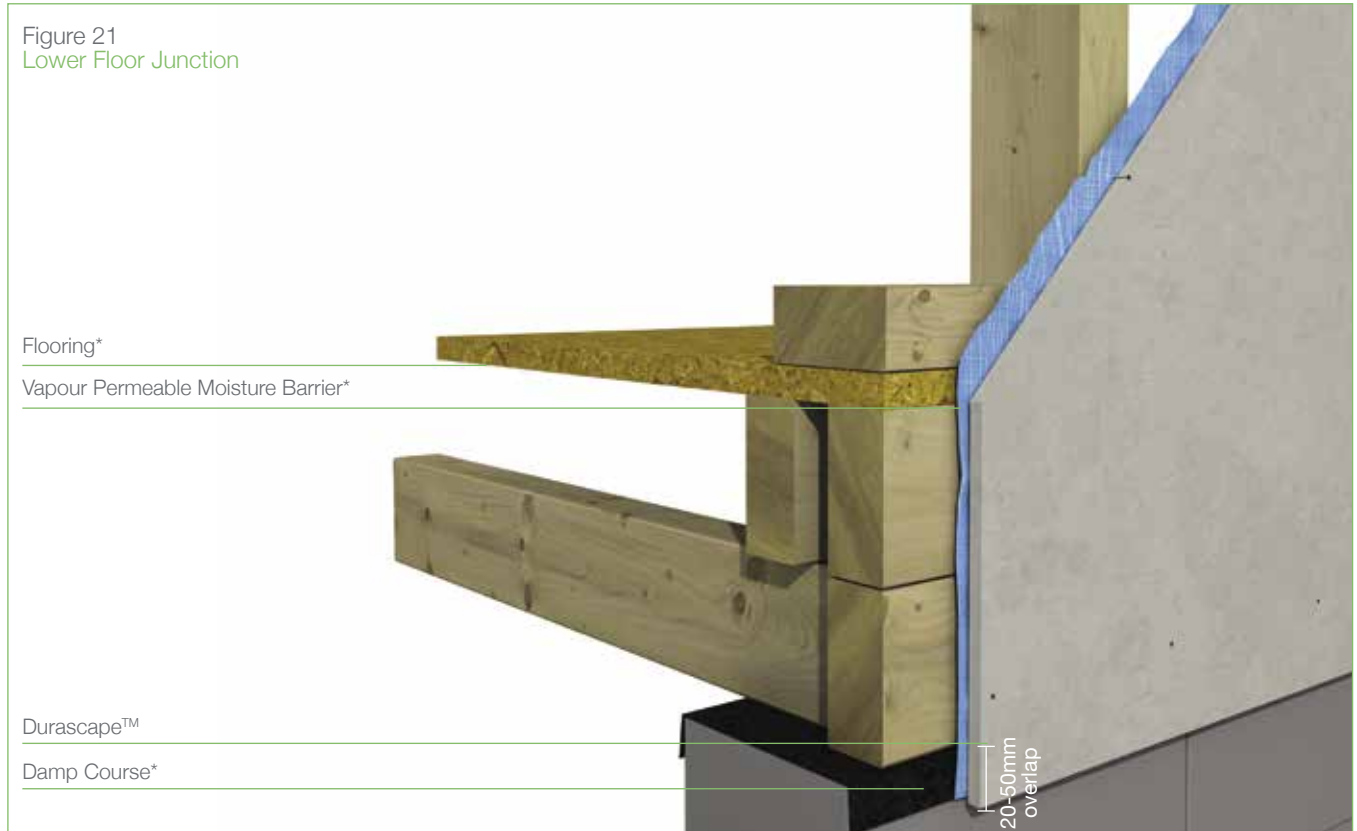
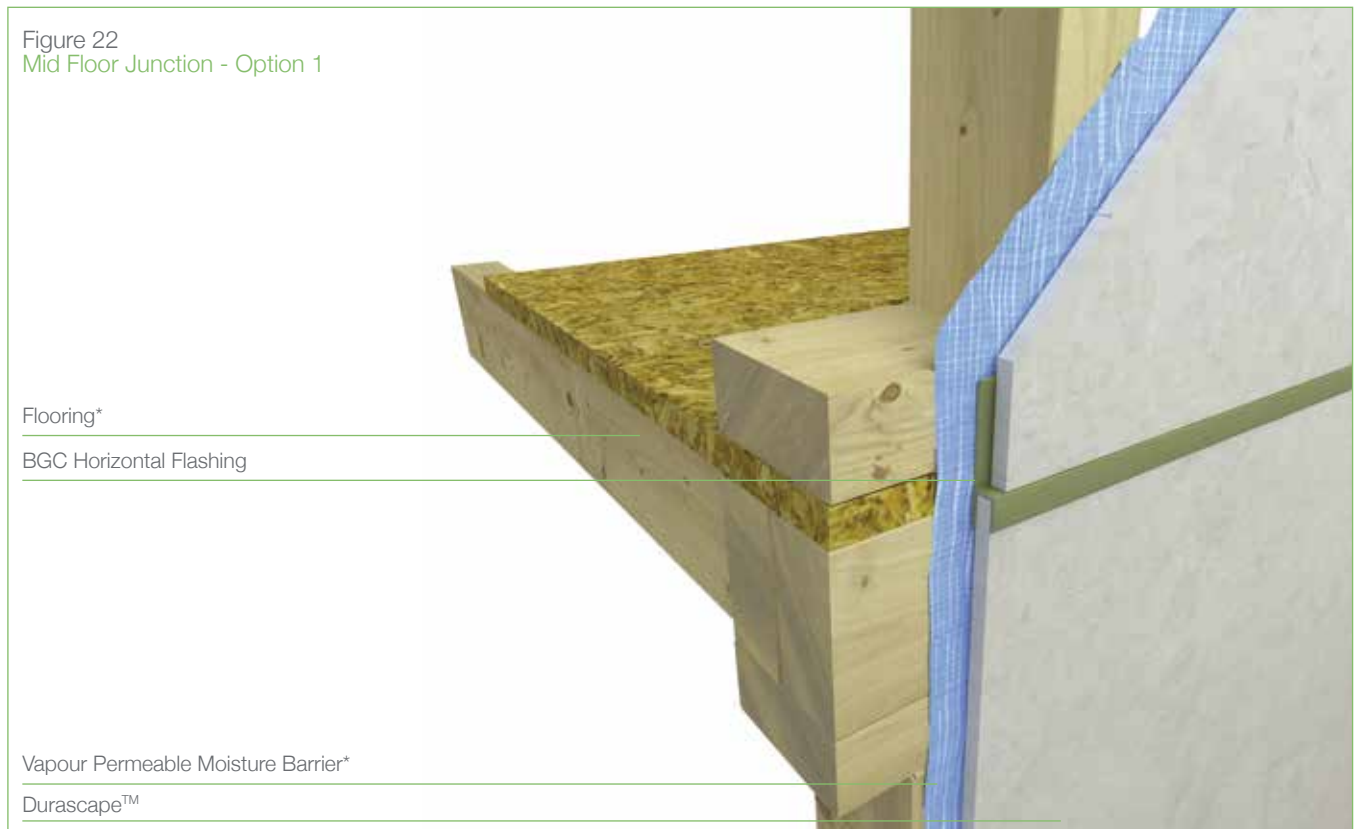

Figure 22
Mid Floor Junction - Option 1



Installation Details

Figure 23
Mid Floor Junction – Option 2

- Continuous bead of sealant
- Durascape™
- Vapour Permeable Moisture Barrier*
- Fix to top sheet only
- Architectural profile or similar*

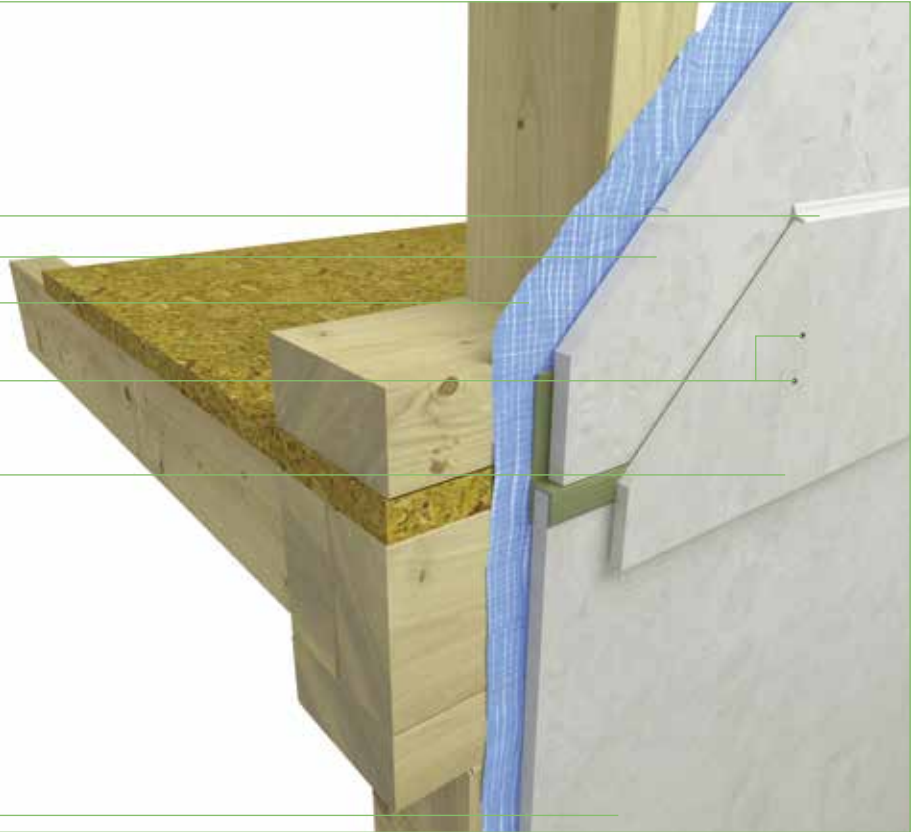

Durascape™

Figure 24
Masonry Wall Horizontal Junction – Option 1

- Durascape™
- Vapour Permeable Moisture Barrier*
- Suitable flashing*
- Damp course*
- Masonry wall*

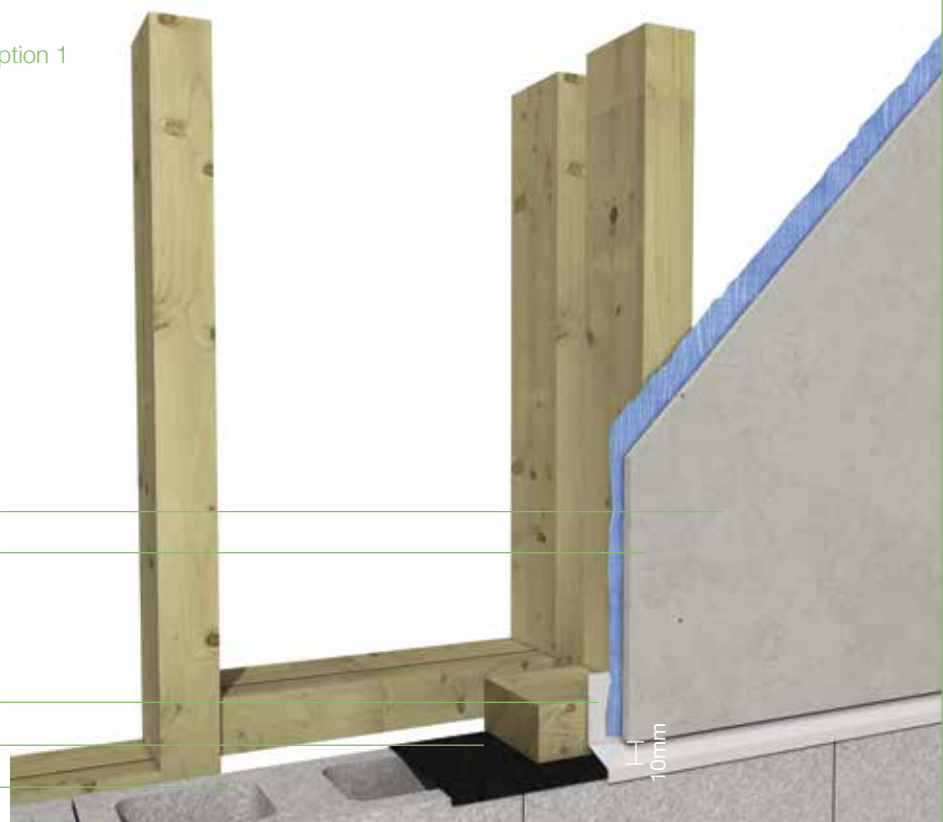

Installation Details

Figure 25
Masonry Wall Horizontal Junction – Option 2

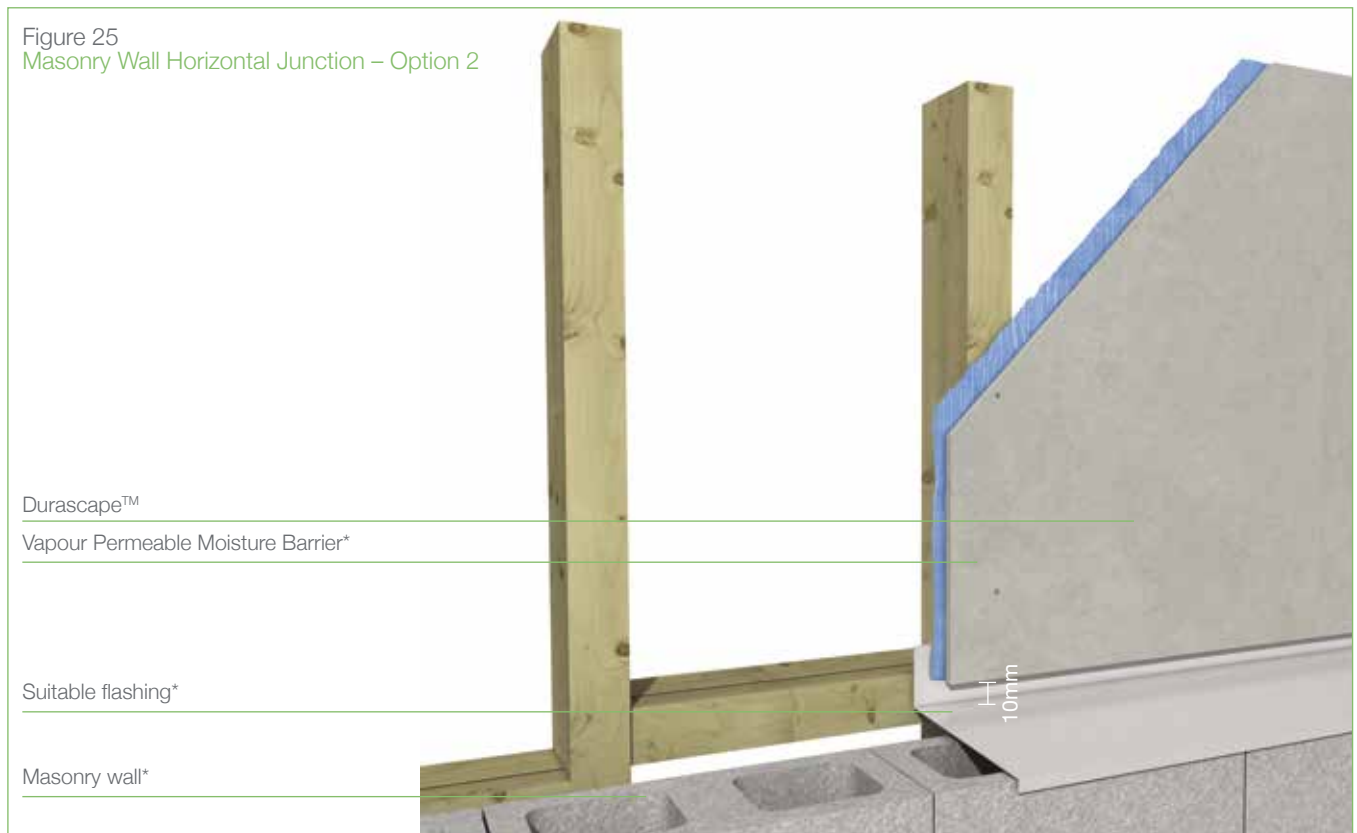

Moisture Management

Designers, specifiers and builders have a duty of care to identify moisture-associated risks with any individual building design.

Wall construction design should consider both the interior and exterior environments of the building to effectively manage moisture. Special consideration should be given to buildings that are in extreme climates or at higher risk of wind driven rain.

In addition, all wall openings, penetrations, junctions, connections, window heads, sills and jambs must incorporate appropriate flashing for waterproofing. All other components, materials and installation methods used to manage moisture in walls should comply with the relevant standards of the National Construction Code (NCC) .

Thermal Breaks – Steel Frame

Thermal breaks may be required for steel framed buildings, in walls that are required to have a minimum total R value. Careful consideration of thermal heat transfer and the position of thermal breaks need to be addressed by the architects, engineers and building designers.

Balustrades, parapets, and other non-enclosing wall elements may not require thermal breaks, except where the possibility of high thermal heat transfer exists through the steel sections to the main structural steel element of the building.

Thermal breaks are required to have an R value of R0.2 in order to meet the NCC requirement for a Thermal Break.

NOTE // Thermal breaks should be installed over the vapour permeable moisture barrier.

Where the vertical thermal break meets the horizontal thermal break a gap of 3mm should be left to allow moisture to escape. Install Thermal Breaks continuously to all vertical framing first, then all horizontal framing.

Figure 26
Thermal Breaks

Thermal Break Tape*
Vapour Permeable Moisture Barrier*
Durascape™

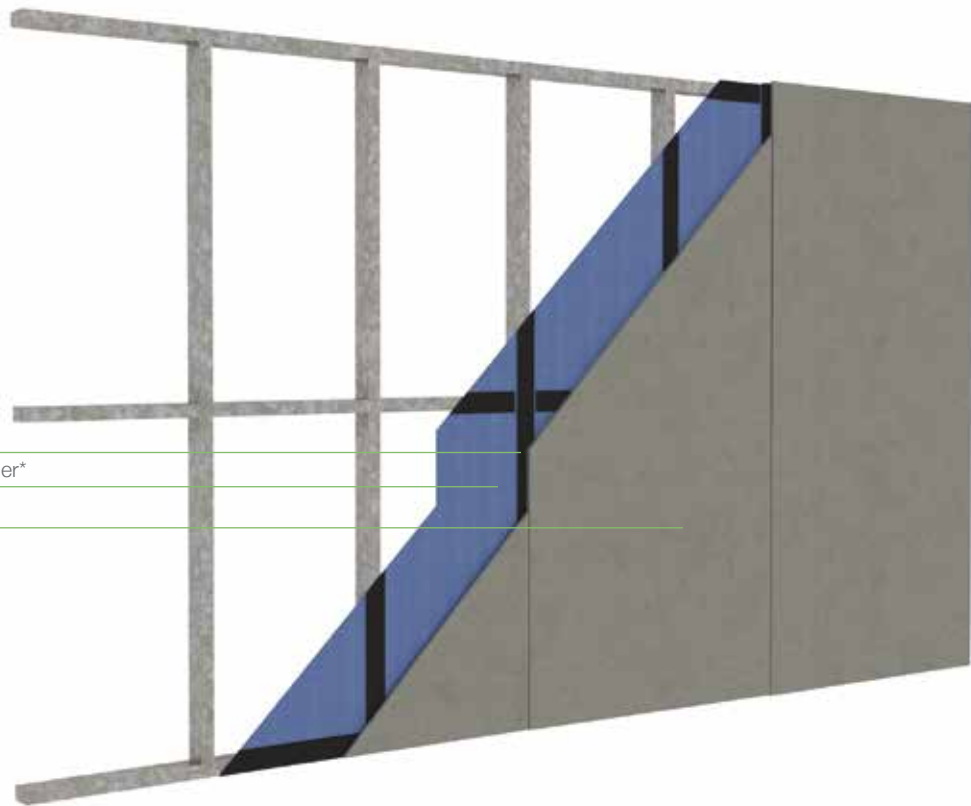

Bushfire and Boundary Wall Areas – Timber Frame

AS3959:2009 sets out a series of Bushfire threat levels to buildings described as BAL (Bushfire Attack Levels) as follows: BAL-Low, BAL-12.5, BAL-19, BAL-29, BAL-40 or BAL-FZ (Flamezone).

Durascape™ is eminently suited for both bushfire and boundary wall applications in residential and multi-residential buildings.

Bushfire AS3959:2009 Applications

Durascape™ may be used as a stand-alone product to achieve up to BAL 40 when fixed direct to frame as per the fixing instructions in this manual.

Durascape™ when used in conjunction with GTEK™ Fire and Wet Area 16mm will comply with the requirements of AS3959:2009 and AS1530.4 to achieve BAL FZ>10.

Boundary/Exterior Walls

Durascape™ in conjunction with GTEK™ Fire and Wet Area 16mm can achieve both 60/60/60 and 90/90/90 FRL fire ratings from the outside as required by the NCC.

Where an exterior wall is required to achieve 60/60/60 FRL (Fire Resistance Level) from the outside, 1 layer of GTEK™ Fire and Wet Area 16mm installed with Durascape™ over the GTEK™ Fire and Wet Area 16mm will meet minimum NCC requirements.

Similarly 2 layers of GTEK™ Fire and Wet Area 16mm used in conjunction with Durascape™ will achieve 90/90/90 from the outside.

NOTE: All exterior walls must have vapour permeable moisture barrier directly behind the Durascape™. No adhesives are to be used when installing GTEK™ Fire and Wet Area 16mm and the Durascape™. Nails or screws must be used.

For more information please contact your nearest BGC Fibre Cement office.

Figure 27
Boundary Wall System

GTEK™ Wall
GTEK™ Fire and Wet Area 16mm
EPDM Foam Gasket
Vapour Permeable Moisture Barrier*
Durascape™

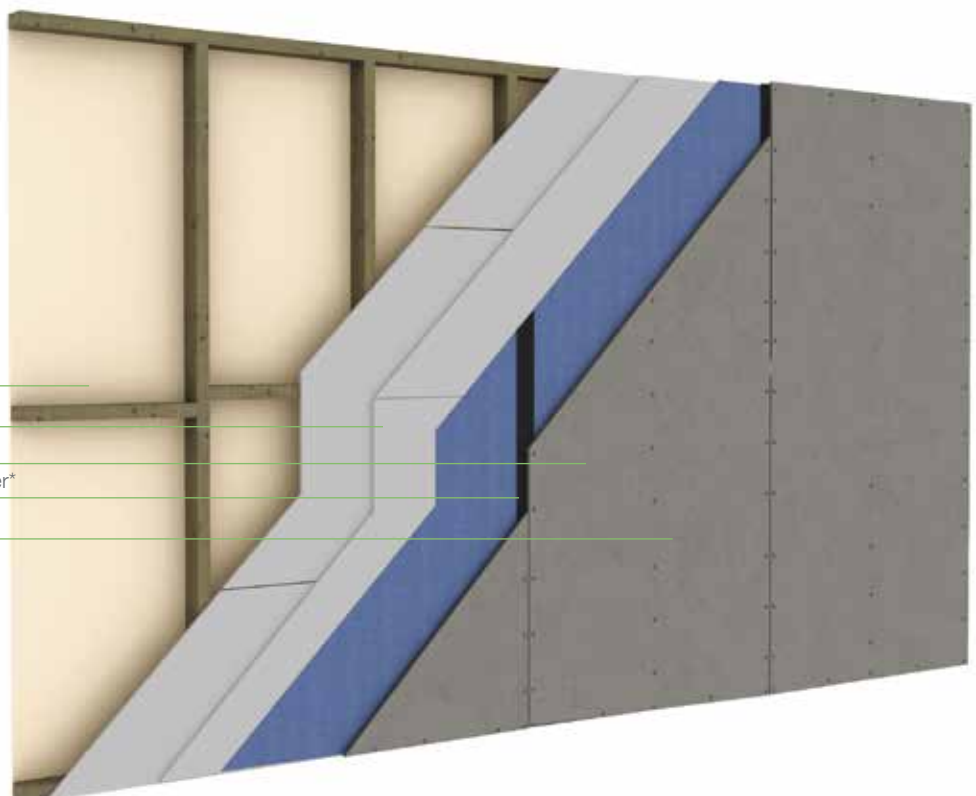

Painting

To enhance both the appearance and performance of Durascape™, BGC recommends that at least two coats of 100% acrylic exterior grade paint be applied. The paint manufacturer's recommendation on application and maintenance of the paint system should be followed.

It is recommended that Durascape™ is painted according to the paint manufacturer's instructions within three months following delivery to site.

Should Durascape™ be exposed to the elements for a period beyond the initial three months to achieve an optimum finish an additional priming coat is recommended prior to the top finishing coats being applied.

Ensure that Durascape™ is dry and clean prior to applying a quality exterior paint system.

Note: BGC recommends the use of a roller or brush application for best results.

Maintenance

Durascape™ when used in accordance with this literature requires no direct maintenance.

To guard against water penetrating the structure and damaging the framework, annual inspections of the cladding system should be carried out. Check flashing, sealant joints and paint work.

Flashings and sealants must continue to perform their design function.

Damaged sheets should be replaced as originally installed. Paintwork should be maintained in accordance with the manufacturer's instructions.

Insulation

Durascape™ sheets will require insulation to be installed in some regions that have thermal loss regulations. Insulation should be installed in accordance with the manufacturer's instructions. Insulation batt must fit snugly between framing members to minimise heat loss.

Deemed to Comply

The NT Deemed to Comply Manual (DTCM) is referenced in the Building Code of Australia, Volume 2, Part 3.10.1 as an acceptable construction manual for high wind areas.

Durascape™ is suitable to be used in high wind environments and is Deemed to Comply - M/830.

For an up-to-date and complete list of BGC Products that are 'Deemed to Comply' please refer to www.ntlis.nt.gov.au/deemedtocomply

Warranty

We warrant that our products are free from defects caused by faulty manufacture or materials for the following period from the date of purchase:

- 25 years for the Nuline™ Plus, Stratum™ and Duraplank™ ranges
- 10 years for the Montage™ range and
- 15 years for all other BGC Fibre Cement and Innova™ ranges

If you acquire any defective products, we will repair or replace them, supply equivalent replacement products or refund the purchase price within 30 days of receiving a valid claim, subject to product inspection and confirmation of the existence of a defect by BGC. We will bear the cost of any such repair, replacement or refund.

This warranty is given by:

BGC Fibre Cement Pty Ltd

Ground Floor, 290 Bushmead Road, Hazelmere WA 6055
Phone 08 9374 2900 Fax 08 9374 2901

To claim under this warranty, you must provide proof of purchase as a consumer and make a written claim (including any costs of claiming) to us at the address specified above within 30 days after the defect was reasonably apparent, or if the defect was reasonably apparent prior to installation, the claim must be made prior to installation. You may not claim under this warranty for loss or damage caused by:

- faulty or incorrect installation by non-BGC installers (BGC's installation procedures are at www.bgcinnovadesign.com.au);
- failure to comply with the Building Code of Australia or any applicable legislation, regulations approvals and standards;
- products not made or supplied by BGC;
- abnormal use of the product; or
- normal wear and tear.

The benefits available under this warranty are in addition to other rights and remedies of the consumer under the law. Our goods come with guarantees that cannot be excluded under the Australian Consumer Law. You are entitled to a replacement or refund for a major failure and for compensation for any other reasonably foreseeable loss or damage.

You are also entitled to have the goods repaired or replaced if the goods fail to be of acceptable quality and the failure does not amount to a major failure.

Terms and Conditions

BGC Fibre Cement's Terms and Conditions of Sale ("Agreement"), as in place and published at the date of this brochure, which are available upon request or on our website at www.bgcinnovadesign.com.au. The purchaser's terms and conditions, howsoever provided, do not form part of the Agreement.

Adelaide
Telephone
08 8480 1700

Sydney
Telephone
02 8107 9500

Brisbane
Telephone
07 3548 8400

New Zealand
Telephone
0011 64 9273 1457

Melbourne
Telephone
03 9492 1700

Technical Helpline
1300 652 242

Perth
Telephone
08 9374 2900

Exterior products and applications
INNOVA™ RANGE OF PRODUCTS

DURACOM™ / A compressed fibre cement facade system.

DURAFLOOR™ / The ultimate flooring product that can be used in both interior and exterior applications.

DURAGRID™ RESIDENTIAL & DURAGRID™ LIGHT COMMERCIAL / A lightweight facade giving a modern and durable finish.

DURAGROOVE™ / A vertically grooved exterior facade panel.

DURASCAPE™ / A lightweight exterior facade base sheet with a subtle vertical shadow line.

DURACOM GREYSTONE™ / A pre-finished facade system.

MONTAGE™ / A pre-finished versatile facade system that can be used internally and externally.

NULINE™ PLUS / A weatherboard style cladding system.

STONESHEET™ / Purpose designed substrate for stone tile facade.

STRATUM™ / A range of plank products, each of which can be used as stand-alone products or used together to create a striking exterior cladding solution.

Interior products and applications
INNOVA™ RANGE OF PRODUCTS

INTERGROOVE™ / Internal grooved wall lining.

Exterior products and applications
BGC FIBRE CEMENT RANGE OF PRODUCTS

DURASHEET™ / Ideal for the cladding of gables and lining of eaves. Can also be used on commercial soffits and cladding on non-impact areas.

DURAPLANK™ / Available in Smooth, Woodgrain and Rusticated finishes, Duraplank™ is ideal for exterior cladding of upper storey conversions or ground level extensions.

DURATEX™ / A base sheet used for textured coatings on exterior wall applications.

DURALINER™ PLUS / An exterior lining board that is the perfect substrate for tiles and is ideal for wet areas.

COMPRESSED / Used as a domestic, commercial sheet for wet areas, flooring, partitions, exterior decking, fascia and facade cladding.

DURALUX™ PLUS / Suitable for exterior applications where it will be sheltered from direct weather.

Interior products and applications
BGC FIBRE CEMENT RANGE OF PRODUCTS

DURALUX™ PLUS / An interior lining board suitable for ceilings and soffits.

DURALINER™ PLUS / An interior lining board, this is the perfect substrate for tiles and is ideal for wet areas.