

cowdroy

BARRIER DOORS

SUPERIOR | BIRCHGROVE | FEDERATION | PADDINGTON | HARRINGTON | BALMAIN



6 EASY STEPS TO SELECT & ORDER YOUR BARRIER DOOR

HOW TO ORDER YOUR CUSTOM BUILT BARRIER DOOR

① CHOOSE YOUR BARRIER DOOR STYLE

Below is the range of Barrier Door styles.



SUPERIOR

Minimum Size - 1810mm H x 507mm W
Maximum Size - 2500mm H x 1300mm W

High quality frame with 316 grade stainless steel mesh



BIRCHGROVE

Minimum Size - 1510mm H x 507mm W
Maximum Size - 2512mm H x 1365mm W

High quality frame, diamond pattern panel insert and standard fibreglass screen



FEDERATION

Minimum Size - 1940mm H x 760mm W
Maximum Size - 2120mm H x 920mm W

High quality frame, decorative panel insert and standard fibreglass screen



PADDINGTON

Minimum Size - 1950mm H x 760mm W
Maximum Size - 2120mm H x 920mm W

High quality frame, decorative panel insert and standard fibreglass screen



HARRINGTON

Minimum Size - 1850mm H x 760mm W
Maximum Size - 2120mm H x 920mm W

High quality frame, decorative panel insert and standard fibreglass screen



BALMAIN

Minimum Size - 1833mm H x 760mm W
Maximum Size - 2120mm H x 920mm W

High quality frame, decorative panel insert and standard fibreglass screen

② CHOOSE YOUR COLOUR COMBINATIONS

Door	Handle & Optional Door Closer
	White
	White Birch
	Primrose
	Stone Beige
	Black
	Brown
	* Woodland Grey
	* Hawthorn Green
	* Colour options not available for sliding doors

MEASURE & RECORD YOUR DETAILS

③ MEASURE YOUR DOOR OPENING

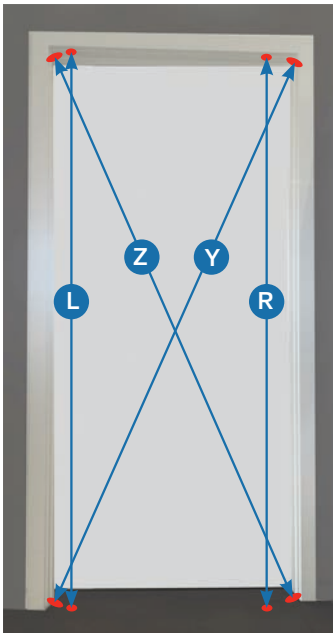

HEIGHT

L	mm
R	mm

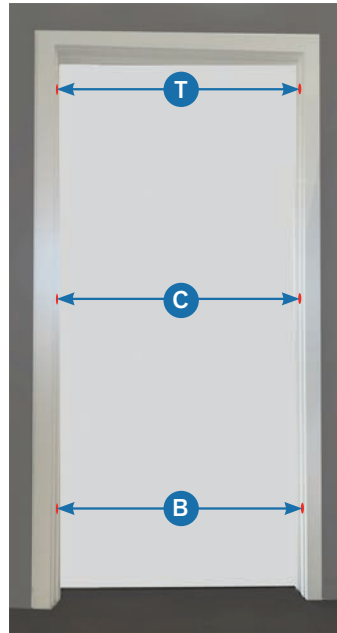

DIAGONAL

Y	mm
Z	mm



Always measure on the other side of the jamb from which the entry door sits.

WIDTH

T	mm	B	mm
C	mm		

④ LOCK/HANDLE

Check the space between your existing door lock and the outside face of your jamb. The gap required to ensure your new barrier door fits is minimum 20mm.

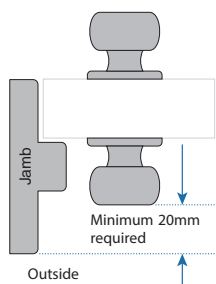

HANDLE DIMENSIONS

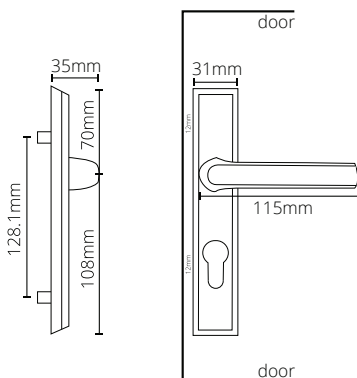

⑤ HANDLE SIDE

From the outside looking in, choose your handle side. *Usually the same side as your existing door.*



L/H Side



R/H Side

LOCK INSTALLATION TROUBLE SHOOTING



Watch the Video:



⑥ HANDLE HEIGHT

How high would you like your handle?

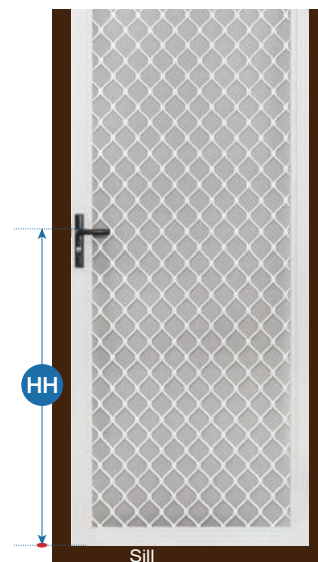

IMPORTANT
Ensure the height of the handle of your new barrier door will not collide with the handle of your existing door when closed.

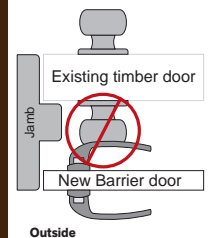

For existing doors
Measure from sill to middle of lock tongue

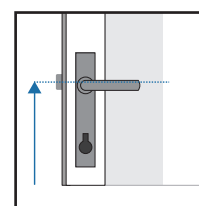

HH	mm
-----------	----

600mm min. - 1500mm max.

HINGED BARRIER DOOR ORDER FORM

(For New and Replacement Doors)



STANDARD INCLUSIONS

Using the guide to the left complete this form to order your new barrier door.
 Note: Take extra care with your measurements as your door cannot be altered once it has been made.

1. Select door style What style of door would you like?



Superior
 Birchgrove
 Balmain
 Harrington
 Federation
 Paddington

1: Max 2500H x 930W Max 2512H x 1365W
 Min 1800H x 500W Min 1510H x 507W
 2: Max 2500H x 1300W
 Min 1800H x 900W

* Large SUPERIOR doors may require a mid support rail.

2. Which colour finish would you like your door (options on page 2)

3. Enter your door opening sizes in column A
 OR your existing door size in column B

A		OR	B	
Door Opening		Less	Existing Door Size	
Y	mm	TYPE OF ARCHITRAVE <input type="radio"/> Timber <input type="radio"/> Steel		
Z	mm			
L	mm	-10mm		mm
R	mm	-10mm		mm
T	mm	-7mm		mm
C	mm	-7mm		mm
B	mm	-7mm		mm

4. Select your handle colour. Available colours shown below

White
 White Birch
 Primrose
 Stone Beige
 Black
 Brown
 Wood Grey
 Hawth. Green

5. Select your handle side. (From the outside looking inwards)

LEFT RIGHT

6. Enter your handle height. (From bottom of sill to centre of lock tongue) min 600mm / max 1500mm

HH mm

(NOTE: For Triple Lock option - fittings will be located at an equal distance above and below this nominated handle height)

For warranty details please visit www.cowdroy.com.au

OPTIONAL ACCESSORIES

Optional Extras not for Individual Sale

A. Extra security - Triple lock
(Hinged Doors Only)

B. Stainless Steel Mesh
Upgrade for all doors. Included as standard for Superior Doors
Max height 2507mm (Not available for Birchgrove Door)

C. Pet Mesh
Not available for Superior Door

D. Perspex Pet Door SMALL
(Available for Superior & Birchgrove Doors Only)
 MEDIUM
 LARGE
 HINGE SIDE HANDLE SIDE

E. Door Closer (Hinged Doors Only)
 Select colour (Available colours shown below)
 White
 White Birch
 Primrose
 Stone Beige
 Black
 Brown
 Wood Grey
 Green Hawth

F. Bug Seal

Please email your completed form to:
cowdroy@cowdroy.com.au

Order No.	
Customer name	
Customer contact No.	
Store	
Suburb	
Staff member	
Date	
Customer Signature	*

* By signing this I understand that the measurements I have provided are correct.

Once order is placed with Cowdroy no further alterations can be made after 24 hours of receipt.

SLIDING BARRIER DOOR ORDER FORM

(For Replacement Doors only)



1 MEASURE YOUR EXISTING DOOR

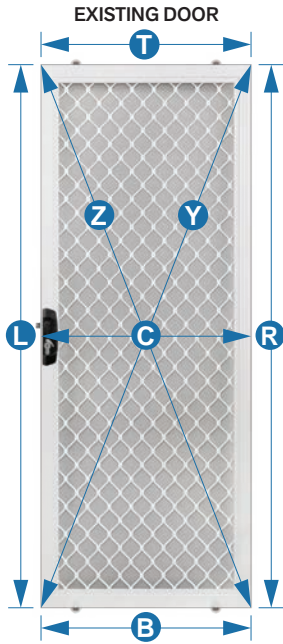

HEIGHT

L mm

R mm

DIAGONAL

Z mm

Y mm

WIDTH

T mm

C mm

B mm

2 CURRENT HANDLE SIDE

From the outside looking in, nominate your handle side.



L/H Side



R/H Side

3 HANDLE HEIGHT



HEIGHT

HH mm

600mm min. - 1500mm max.

Measure from **bottom of door frame** to centre of lock

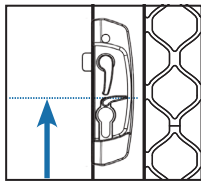

Supplied with 4 x concave rollers (2 x top & 2 x bottom)

STANDARD INCLUSIONS

1. Select door style

* Superior

Birchgrove



1: Max 2500H x 930W
Min 1800H x 500W

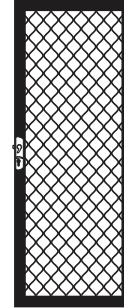

Max 2512H x 1365W
Min 1510H x 507W

2: Max 2500H x 1300W
Min 1800H x 900W

2. Confirm your door sizes (Make-to size)

L mm

R mm

Z mm

Y mm

T mm

C mm

B mm

* Large SUPERIOR doors may require a mid support rail.

3. Enter door colour

(Refer colour range on page 2.)

4. Current handle side

(From the outside looking inwards)

LEFT

RIGHT

5. Enter handle height

(From bottom of door frame to centre of lock)

HH mm

White White Primrose Stone Black Brown
Birch Birch Beige

6. Select handle colour

(Available colours shown below)

OPTIONAL EXTRAS

(Optional Extras not for Individual Sale)

A. Pet Mesh (Birchgrove Door only)

B. Perspex Pet Door

(Available for Superior & Birchgrove Doors Only)

SMALL

MEDIUM

HINGE SIDE

HANDLE SIDE

LARGE

C. Bug Seal

Order No.	
Customer name	
Customer contact No.	
Store	
Suburb	
Staff member	
Date	
Customer Signature	*

* By signing this I understand that the measurements I have provided are correct and that this is for a replacement door only. No tracks will be included.

Once order is placed with Cowdroy no further alterations can be made after 24 hours of receipt.

The Cowdroy Barrier Door range offers a selection of standard and custom built quality screen doors in a range of designs and colours that will enhance and compliment the look of your home.

All doors come with the following:

- Heavy duty extruded aluminium frame
- Double cylinder lock with deadlocking and privacy functions
- 2 hinges per door - screws for wood frame
- 21 standard powder coat colours to choose from
- A range of popular optional accessories
- Custom made to your sizes
- Australian made
- See www.cowdroy.com.au for warranty details

SUPERIOR DOOR

Features a high quality and impact resistant #316 grade woven stainless steel mesh fitted inside the frame by way of a double locking wedge and an acrylic adhesive. The "Superior" door combines strength and quality with an unobtrusive view.

BIRCHGROVE

Popular diamond grille door made to order.

PADDINGTON, FEDERATION, HARRINGTON, BALMAIN

Features a decorative cast aluminium panel fitted within the frame and finished with a quality fibreglass mesh.

There are 4 highly popular panel inserts available in the range, each of which are finished in the same durable powdercoat as the frame.

This range combines elegance with quality and will give your home a new look.

BARRIER DOOR OPTIONAL EXTRAS NOTE : OPTIONAL EXTRAS NOT FOR INDIVIDUAL SALE

<p>✓ TRIPLE LOCK</p> <p>Upgrade your lock option to an Austral EKIT triple lock for increased locking security.</p>	<p>✓ DOOR CLOSER</p> <p>Add a pneumatic door closer to automatically return your door to its closed position.</p>	<p>✓ PET DOORS* <small>*Suitable for Superior & Birchgrove doors only</small></p> <p>Pet doors are ideal for those requiring pet access Available in 3 sizes Small (190x240mm), Medium (255x305mm) & Large (260x400mm)</p>	<p>✓ BUG SEAL</p> <p>Consider a bug seal to help keep out those unwanted pests. All bug seals are finished in the same colour as your door.</p>
--	--	---	--

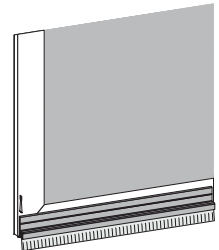
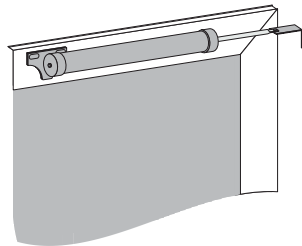
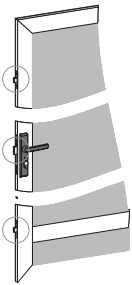

✓ SUPERIOR MESH

For increased security upgrade your mesh to Stainless Steel

✓ PET MESH

Protect your pet by upgrading your mesh to a pet-friendly durable mesh.

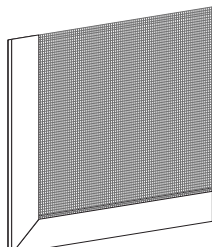
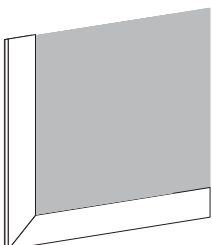



3 Easy Steps to a Custom Built Barrier Door

1

FOLLOW THE BROCHURES SIMPLE INSTRUCTIONS TO HELP MAKE YOUR SELECTION

Measure carefully as per instruction listed, check twice and write clearly with a black pen.

2

TAKE YOUR COMPLETED FORM TO THE STORE YOU WISH TO ORDER FROM

Ensure you have correctly filled out all the required fields and that you have nominated your door style, colour and desired options.

3

YOUR ORDER WILL BE DELIVERED TO YOUR LOCAL STORE FOR CUSTOMER PICK UP

Delivery is 10 working days for east coast metropolitan areas, 10-15 working days for east coast regional areas and up to 20 working days for all other areas in Australia.

STORE STAMP

Cowdroy is an Australian company supplying industry leading products across residential and commercial properties.

Established in 1890, Cowdroy specialises in door tracking systems, weather seals, insect screen, replacement wheels & rollers and more products for a wide range of applications.

For all our product information visit the Cowdroy website at:
www.cowdroy.com.au

HEAD OFFICE SYDNEY

38 Redfern St
Wetherill Park, NSW 2164
Phone: (02) 9604 3000
Fax: (02) 9604 8129
Sales Fax: (02) 9609 3694

Perth

1 Modal Crescent
Canning Vale, WA 6155
Ph: (08) 9455 5354
Fax: (08) 9455 5461

WEBSITE

www.cowdroy.com.au
www.cowdroy-insectscreen.com.au

EMAIL

sales@cowdroy.com.au

NATIONAL CALL

1800 COWDROY (1800 269 376)

Christchurch NZ

56 Treffers Road, Sockburn
Christchurch 8042
Phone: (03) 943 2060
Fax: (03) 943 2061

Auckland NZ

18 Kerwyn Ave, East Tamaki
Auckland 2013
Phone: (09) 274 7279
Fax: (09) 274 4453



cowdroy

**ALCHIN
LONG
GROUP**

Custom_Built_Barrier_Doors_21.1.10.22