



**INSTALLING YOUR
PLATINUM
9000
CAVITY UNIT**

INSTALLING YOUR PLATINUM 9000 CAVITY UNIT

Thank you for purchasing the Platinum 9000 Ceiling Height Cavity Door Unit.

Please follow these instructions carefully. Proper installation and maintenance will bring you years of trouble-free use.

IMPORTANT INFORMATION:

Single cavity units have a door weight limit of 125kg. Double cavity units have a door weight limit of 85kg each door. Cavity units are not load bearing. When installing double cavity units it is important that the track is fixed to a structural member. Screw through the centre of track using the holes provided. Only use button head screws (not provided in fittings). Care should be taken when installing the cavity unit into wall tiled areas. Please consult with the substrate/tile manufacturer as to their recommended fixing and tiling methods in accordance with the relevant standards.

Do not remove the temporary spacer plates in the opener of the cavity throat until the wall sheeting has been completed.

CONTENTS:

Check that you have all the contents and tools to install your Platinum 9000 Ceiling Height Cavity Door Unit.

The Platinum 9000 Cavity unit requires the same fittings as the Platinum 6000 Cavity unit. Fittings are universal for both systems, however, the **add-on pack** (included) is required for the Platinum 9000 Cavity unit to complete the installation.

Contents include:

- 1 x cavity pocket
- 1 x head track assembly
- 1 x closing jamb
- 2 x trolleys with 1/4" hex nut and screw set
- 2 x door plates
- 1 x reversible door guide
- 1 x door plate wedge remover
- 2 x door plate wedges
- 1 x O.E. spanner
- 1 x trolley removing tool
- 4 x 30mm hex head screws (door plate screws)
- 2 x 16mm pan head screws (door guide screws)
- 10 x 32mm button head metal thread screws (head to pocket fixing)
- 4 x 65mm hex head metal thread screws (back member to stud fixing)
- 1 x concrete nail (floor fixing)
- 2 x 60mm converter bumper stops

Platinum 9000 Cavity Elevation

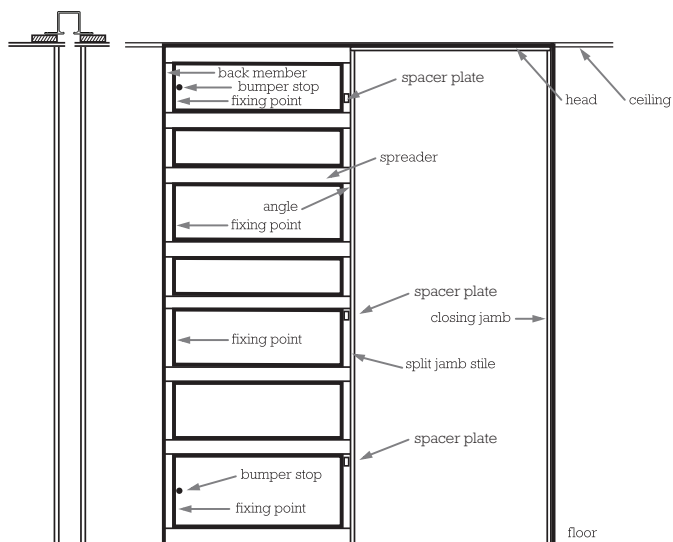

Cavity unit with door in fully open position

Flush Jamb

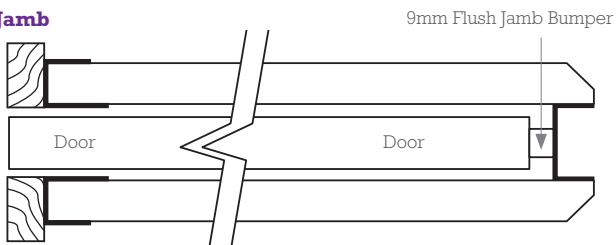

Flush Pull

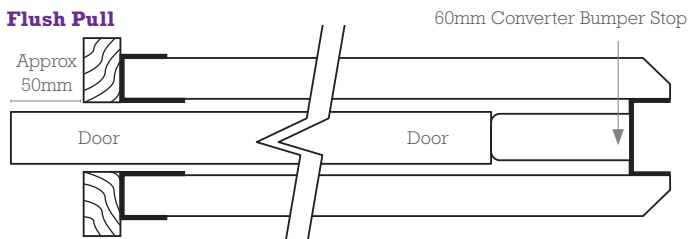

Please note: To convert a flush jamb cavity unit into a flush pull unit install the 2 x 60mm converter bumper stops (included in the fittings) onto the back member as close as possible to the existing bumper stops. Some unit sizes/types may not be available in all states.

STEP 1

Locate the cutout on the track wings onto the back member. Ensure the two nylon lugs on the track wings are located between the galvanised angle to the pocket. Screw the track assembly to the pocket using the 10 x 32mm button head metal thread screws supplied.

STEP 2

Cut the closing jamb stile to length. Screw/nail (not provided in fittings) closing jamb stile to head section fixing through aluminium track into the closing jamb stile.

Note: If a double door unit is being installed a closing jamb stile is not supplied. Insert the two door stops at the centre of the track.

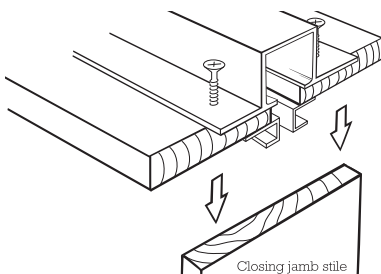

STEP 3 Slide both trolleys into the track using the slot located in the track inside the cavity pocket.

STEP 4

Stand unit in wall opening. Pack, plumb and level unit and fix securely into position. It is important that the back member of the cavity pocket is installed by packing and fixing as close as possible to the two bumper stops.

A minimum of four fixings are required. - See platinum 9000 Cavity Elevation. Use the 4 x 65mm metal thread hex head screws.

STEP 5 Fix cavity pocket to the floor using 1 x concrete nail into fixing plate attached to the bottom of cavity. **Do not remove the temporary spacer plates in the opening of the cavity unit throat until the wall sheeting has been completed.**

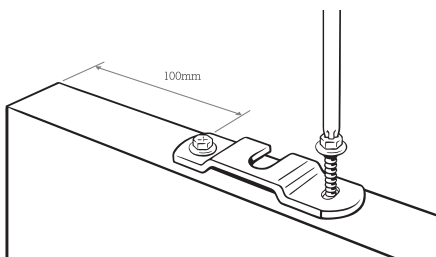

STEP 6

Fix the 2 x door plates to the top of the door 100mm from each edge using the 4 x 30mm hex head screws. The door plates must be in the middle of the top rail with both slots facing the same way.

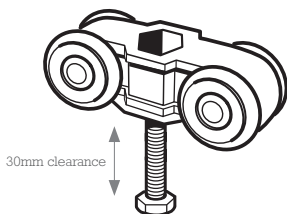

STEP 7 Wind the 2 x trolley set screws down to give a clearance of approximately 30mm from the underside of the trolley to the head of the set screw. Ensure the correct length bolts have been inserted into the trolley as per the additional instructions included in the Platinum 9000 **add on pack**.

Note: Do not use the lock nut between the door plate and the trolley.

STEP 8

Position the trolley approximately 100mm from the cavity pocket.

STEP 9 Lift the door and slide the set screw under the bracket.

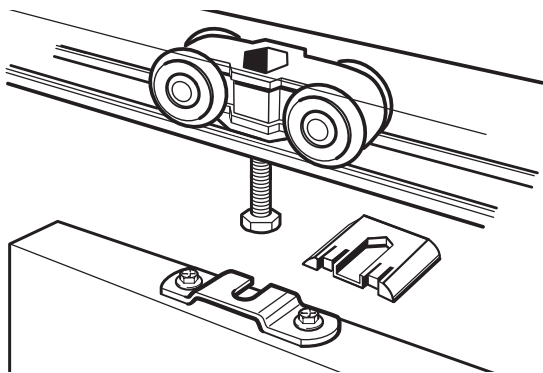

STEP 10

Slide door partially into the pocket and fit second trolley as in step 9.

STEP 11 Adjust the door height and plumb to closing jamb stile by turning bolt head with 1 x O.E. spanner provided. The top of the door should finish 8-9mm from the underside face of the finished plaster. Ensure the door slides smoothly.

STEP 12 Slide the reversible door guide along the groove in the bottom of the door. Loosely screw guide to the split jamb using the 2 x 16mm pan head screws. Centre the door in the pocket and then fully tighten screws.

STEP 13

After final adjustment, using the wedge remover, insert the 2 x door plate wedges through the 2 x door plates ensuring the lugs are hard against the door plate edges.

Double Units - are supplied with a one piece head and track and are fitted in a similar manner to single units.

Two door stops are provided and should be fitted to the track so that the doors do not slam when closed. Refer to Step 3 and insert at same time as the trolleys.

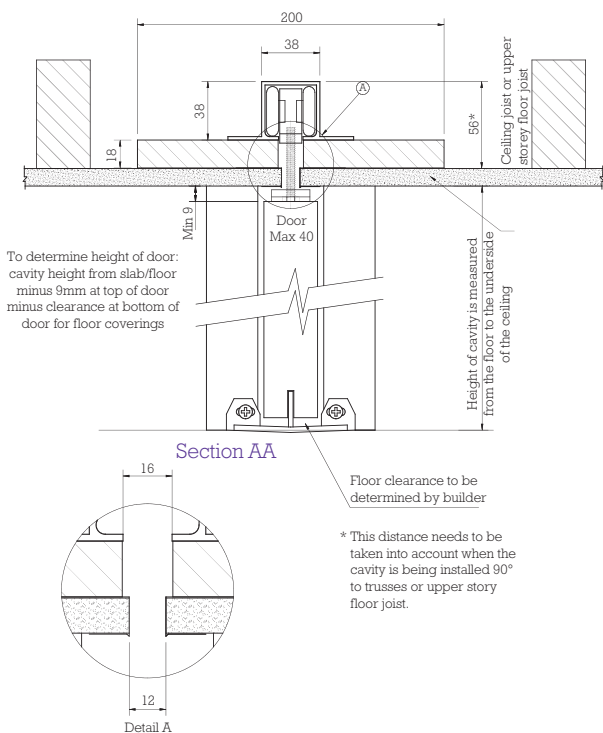

Removing Door. Push down on the lugs on the 2 x door plate wedges using the wedge remover supplied. Remove the door plate wedges from the door plates. Wind down the set screws on the trolleys using the O.E. spanner provided until there is enough clearance to clear the plaster lining. Remove the door from the trolley closest to the closing jamb stile and move door outwards. Use the same procedure for the trolley closest to the pocket. Trolleys can be removed from the opening in the track located inside the pocket using the trolley removal tool.

Finishing. Ensure fixing screws from the plasterboard do not penetrate through the pocket spreaders. Ensure the head of the unit is not load bearing

CONTACT

For further information Contact your Corinthian Door Reseller or Corinthian direct:

Sydney (02) 9673 7111

Melbourne (03) 9794 1122

Brisbane (07) 3715 0100

Adelaide (08) 8243 0888

Perth (08) 9455 1333

www.corinthian.com.au



www.corinthian.com.au

Corinthian Industries (Australia) Pty Limited is a subsidiary of Jeld-Wen Australia Pty Limited. Whilst the utmost care is taken to ensure the accuracy of the information contained herein, it is provided in the understanding that the company shall under no circumstances be liable for any injuries, expenses or other losses which may in any way be attributable to the use or adoption of such data and/or design details. All dimensions indicated are nominal only. Corinthian Doors reserves the right to alter or amend without prior notice data and design details specified herein. Photographs or illustrations may not exactly depict the design or specification and may vary to actual. Re-Order Code JWCNAT0434/0519. SEP19 FSA/COR0546-02