



Installation Guide

External Cladding

EasyLap™ Panel
EasyTex™ Panel

EXTERIORS

Australia November 2019

Make sure your information is up to date.

When specifying or installing James Hardie™ products, ensure that you have the current technical information and guides. If in doubt, or you need more information, visit www.jameshardie.com.au or Ask James Hardie™ on 13 11 03.

CONTENTS

1	INTRODUCTION	2
	Scope	2
2	SAFE WORKING PRACTICES	3
	Warning	3
	Recommended safe working practices	3
	Storage and handling	3
3	DESIGN CONSIDERATIONS	4
	Framing	4
	Fasteners	4
4	PRODUCTS AND ACCESSORY DETAILS	5
	Components	5
	Fasteners, Battens and Tapes	6
5	PANEL INSTALLATION - DIRECT FIX	7
6	PANEL INSTALLATION - CAVITY FIX	8
7	INSTALLATION DETAILS - DIRECT FIX	9
	Window Details	9
	External Corner Details	9
	Internal Corner Details	9
	Junction Details	10
7	INSTALLATION DETAILS - CAVITY FIX	11
	Window Details	11
	External Corner Details	11
	Internal Corner Details	12
	Junction Details	12
9	FINISHES AND MAINTENANCE	13
	Finishing	13
	Painting	13
	Maintenance	13
10	PRODUCT INFORMATION	13

1 Introduction

EasyLap™ is a strong fibre cement panel featuring a ship-lapped joint on both vertical edges. Panels are finished on-site using a roll on textured acrylic paint.

EasyTex™ is a strong fibre cement panel featuring a ship-lapped, v-groove joint on both vertical edges. Panels are embedded with a fine modern render texture and are finished on-site using a quality exterior acrylic paint.

Both EasyLap™ and EasyTex™ panels are suitable for use as an external wall cladding in residential single and medium density buildings, including alterations and additions, where a uniform broadwall cladding is required. They are ideal for full wrap or composite construction designs on either timber or light gauge steel framed buildings.

If you are a specifier...

or other responsible party for a project, ensure the information in these specifications is appropriate for the application you are planning and that you undertake specific design and detailing for areas which fall outside the scope of these specifications.

If you are an installer...

Ensure that you follow the design, moisture management and associated details and material selection provided by the designer and the EasyLap™ and EasyTex™ Panel Installation Guide.

IMPORTANT NOTES

1. Failure to install, finish or maintain this product in accordance with applicable building codes, regulations, standards and James Hardie's written application instructions may lead to personal injury, affect system performance, violate local building codes, and void James Hardie's product warranty.
2. All warranties, conditions, liabilities (direct, indirect or consequential) and obligations whether arising in contract, tort or otherwise other than those specified in James Hardie's product warranty are excluded to the fullest extent allowed by law. For James Hardie's product warranty information and disclaimers about the information in this guide, visit www.jameshardie.com.au.
3. The builder must ensure the product meets aesthetic requirements before installation. James Hardie will not be responsible for rectifying aesthetic surface variations following installation.

SCOPE

General

This guide covers the use of both EasyLap™ and EasyTex™ panels in a residential wall application over a seasoned timber wall frame or a light-gauge steel frame installed in a vertical upright application.

2 Safe Working Practices

WARNING - DO NOT BREATHE DUST AND CUT ONLY IN WELL VENTILATED AREA

James Hardie products contain sand, a source of respirable crystalline silica which is considered by some international authorities to be a cause of cancer from some occupational sources. Breathing excessive amounts of respirable silica dust can also cause a disabling and potentially fatal lung disease called silicosis, and has been linked with other diseases. Some studies suggest smoking may increase these risks. During installation or handling: (1) work in outdoor areas with ample ventilation; (2) minimise dust when cutting by using either 'score and snap' knife, fibre cement shears or, where not feasible, use a HardieBlade™ Saw Blade (or equivalent) and dust-reducing circular saw attached to an appropriate, well maintained, M-class vacuum or greater with appropriate filter; (3) warn others in the immediate area to avoid breathing dust; (4) wear a properly-fitted, approved dust mask or respirator (minimum P1) in accordance with applicable government regulations and manufacturer instructions to further limit respirable silica exposures. During clean-up use a M-class vacuum or greater with appropriate filter, both of which are well maintained and appropriate for capturing fine (respirable) dust. Alternatively, use wet clean-up methods - never dry sweep. For further information, refer to our installation instructions and Safety Data Sheets available at www.jameshardie.com.au. FAILURE TO ADHERE TO OUR WARNINGS, SAFETY DATA SHEETS, AND INSTALLATION INSTRUCTIONS MAY LEAD TO SERIOUS PERSONAL INJURY OR DEATH.

James Hardie Recommended Safe Working Practices

CUTTING OUTDOORS

1. Position cutting station so wind will blow dust away from the user or others in working area.
2. Use one of the following methods based on the required cutting rate:
 - Best** ■ Villaboard knife ■ Hand guillotine ■ Fibreshear
 - Better** ■ Position the cutting station in a well-ventilated area. Use a dust reducing circular saw equipped with HardieBlade™ Saw Blade or comparable fibre cement blade and well maintained M-class vacuum or greater with appropriate filter appropriate for capturing fine (respirable) dust. Wear a properly-fitted, approved dust mask or respirator (minimum P1).

CUTTING INDOORS

- Cut only using Villaboard knife, hand guillotine or fibreshears (manual, electric or pneumatic).
- Position cutting station in a well-ventilated area

DRILLING / OTHER MACHINING

When drilling or machining you should always wear a P1 dust mask and warn others in the immediate area.

IMPORTANT NOTES

1. For maximum protection (lowest respirable dust production) James Hardie recommends always using best practice cutting methods where feasible.
2. NEVER use a power saw indoors.
3. ALWAYS use a circular saw blade that carries the HardieBlade™ logo or is of at least comparable performance.
4. NEVER dry sweep - Use wet suppression, or an M class vacuum or greater with appropriate filter.
6. ALWAYS follow tool manufacturers' safety recommendations.

DUST MASKS AND RESPIRATORS

As a minimum, an AS/NZS1716 P1 respirator must be used when doing any activity that may create dust. For more extensive guidance and options for selecting respirators for workplaces please refer to Australian/New Zealand Standard 1715:2009 "Selection, Use and Maintenance of Respiratory Protective Equipment". P1 respirators should be used in conjunction with the above cutting practices to minimise dust exposure. For further information, refer to Safety Data Sheet (SDS) available at www.jameshardie.com.au. If concern still exists about exposure levels or you do not comply with the above practices, you should always consult a qualified industrial hygienist or contact James Hardie for further information.

STORAGE AND HANDLING

To avoid damage, all James Hardie™ building products should be stored with edges and corners of the product protected from chipping. James Hardie™ building products must be installed in a dry state and protected from weather during transport and storage. The product must be laid flat under cover on a smooth level surface clear of the ground to avoid exposure to water, moisture, etc.

3 Design Considerations

All design and construction must comply with the appropriate requirements of the current National Construction Code (NCC) and other applicable regulations and standards.

Slab and Footings

The slab and footings on which the building is situated must comply with AS 2870 'Residential slabs and footings – Construction' and the requirements of the NCC.

Ground Clearances

Install James Hardie™ external cladding with a minimum 150mm clearance to the earth on the exterior of the building or in accordance with local building codes if greater than 150mm is required. Maintain a minimum 50mm clearance between James Hardie™ external cladding and roofs, decks, paths, steps and driveways.

Adjacent finished grade must slope away from the building in accordance with local building codes, typically a minimum slope of 50mm over the first metre.

Do not install external cladding such that it may remain in contact with standing water.

NOTE

Greater clearance may be required in order to comply with termite protection provisions, see below for more information.

Termite Protection

The NCC specifies the requirements for termite barriers. Where the exposed slab edge is used as part of the termite barrier system, a minimum of 75mm of the exposed slab edge must be visible to permit ready detection of termite entry.

Structural Bracing

EasyLap™ and EasyTex™ panels can be installed to provide wall bracing against lateral forces due to wind. For further information, Ask James Hardie on 13 11 03.

Fire Rated Walls

EasyLap™ and EasyTex™ panels can achieve fire ratings of 60/60/60 and 90/90/90 when constructed with additional fire rated linings as specified in James Hardie's Fire and Acoustically Rated Design Manual and Construction of Fire and Acoustically Rated Walls Technical Specification. The length of fasteners must be increased for the additional linings.

Moisture Management

It is the responsibility of designer or specifier to identify moisture related risks associated with any particular building design. Wall construction design must effectively manage moisture, accounting for both the interior and exterior environments of the building, particularly in buildings that have a higher risk of wind driven rain penetration or that are artificially heated or cooled.

In addition, all wall openings, penetrations, junctions, connections, window sills, heads and jambs must incorporate appropriate flashing and waterproofing. Materials, components and their installation that are used to manage moisture in framed wall construction must, at a minimum, comply with the requirements of relevant standards and the NCC.

Weather Barrier

A suitable water control membrane must be installed under James Hardie™ cladding in accordance with the AS/NZS 4200.2 'Pliable building membranes and underlays – Installation' and NCC requirements.

James Hardie has tested and certified the use of HardieWrap™ weather barrier for Climate Zones 2-8 within Australia. HardieWrap™ weather barrier is a Class 4 vapour permeable membrane that delivers a triple-shield of protection to help against external weather penetration, internal condensation management and external heat penetration through its safe-glare reflective layer.

If using an alternate product in lieu of HardieWrap™ weather barrier or the project is located in a hot, humid area (Climate Zone 1), the designer must ensure that the product is fit for purpose and it has the following classification in accordance with AS/NZS 4200.1:2017 'Pliable building membranes and underlays – Materials':

TABLE 1

Weather Barrier Classification		
Climate Zone	Water Control Classification	Vapour Control Category
2-8	Water Barrier	Vapour Permeable (Class 3 or 4)
1		Vapour Barrier (Class 1 or 2)

Soft compressible insulation installed between the front of the wall studs and directly behind the external cladding can cause installation issues and is thus not recommended.

Flashing

All wall openings, penetrations, intersections, connections, window sills, heads and jambs must be flashed prior to cladding installation.

FRAMING

General

EasyLap™ & EasyTex™ panels are installed vertically either directly fixed to frame or installed to vertically oriented Scyon™ Cavity Trim to provide a vented cavity, this can be done over either timber or steel frames.

Maximum stud, Scyon™ Cavity Trim and fastener spacing for EasyLap™ and EasyTex™ panels for wind load classifications of AS 4055 'Wind Loads for Housing' are given in Table 1.

FASTENERS

General

All nails must be driven flush. **Before fixing to steel frame, ensure the aesthetic finish of EasyTex™ panels when using HardieDrive™ screws is of acceptable quality prior to installation, see Important Note 3 on page 2 of this guide. Brad nails are recommended for best aesthetic finish.** For more information and advice, Ask James Hardie™ on 13 11 03.

Fastener Durability (Including Coastal Areas)

Fasteners must have the appropriate level of durability and be fully compatible with all other materials required for the intended project. In areas within 1km of a coastal area, areas subject to salt spray and other corrosive environments, class 4 fasteners must be used.

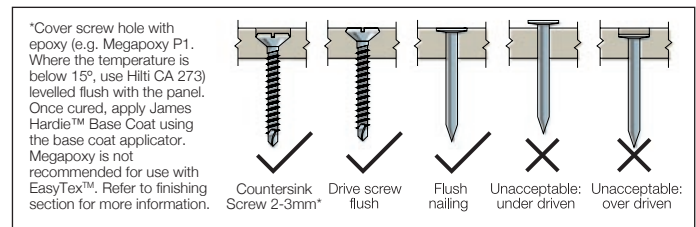

FIGURE 1 NAIL FASTENER DEPTH

TABLE 2

Framing				
Type	Timber		Steel	
Design	Use of timber framing must be in accordance with AS 1684 and the framing manufacturer's specifications		Use of steel framing must be in accordance with NASH standard for Residential and Low-Rise Steel Framing Part 1: Design Criteria and the framing manufacturer's specifications.	
Durability	'Timber used for house construction must have the level of durability appropriate for the relevant climate and expected service life. Reference AS 1684.2 'Residential timber-framed construction'.		The steel framing must have the appropriate level of durability required to prevent corrosion, particularly in coastal areas.	
Tolerances	Ensure frame is square and work from a central datum line. A suggested maximum tolerance of between 3mm and 4mm in any 3000mm length of frame will give best results.			
Thermal Break Requirement	Not required.		For steel frames, the NCC Sections J1.5 and 3.12.1 Volumes 1 and 2 respectively, state for both residential and commercial buildings a thermal break such as HardieBreak™ with an R 0.2m2 K/W must be installed behind external cladding where the cladding and internal lining make direct contact with the same steel frame. Alternatively, off-stud vented cavity installation using Scyon™ Cavity Trim can be used in these applications.	
Fixing Options				
	Direct Fix	Cavity Fix	Direct Fix	Cavity Fix
BMT	NA		From 0.55 to 1.6mm.	
Min. Stud Width	45mm at sheet edges. 35mm at intermediates.	35mm	45mm at sheet edges. 42mm at intermediates.	Min. 32mm
Min. Stud Depth	70mm	70mm	64mm	64mm
Max. Nogging spacing	1350mm	1350mm for on stud batten fixing. 800mm for off stud batten fixing.	1350mm	800mm off stud batten fixing only.

TABLE 3

Maximum Stud, Scyon™ Cavity Trim & Fastener Spacing for EasyLap™ and EasyTex™ Panel Cladding in AS4055 Wind Classification												
Wind Classification	General Areas of Walls (mm)						Within 1200mm of Building Edges (mm)					
	Stud Spacing	Only required for cavity fix			Sheet Fastener Spacing (Except Brad Nails)	Sheet Fastener Spacing (Brad Nails)	Stud Spacing	Only required for cavity fix			Sheet Fastener Spacing (Except Brad Nails)	Sheet Fastener Spacing (Brad Nails)
		Scyon™ Cavity Trim Spacing	Can of be fixed off stud?	Scyon™ Cavity Trim Fastener Spacing				Scyon™ Cavity Trim Spacing	Can of be fixed off stud?	Scyon™ Cavity Trim Fastener Spacing		
N1, N2, N3/C1	600	600	Yes	300	200	125	600	600	Yes	300	200	125
N4/C2	600	600	Yes	300	200		450	450	No	200	150	
N5/C3	600	600	No	200	200		300	300	No	200	150	
N6/C4	450	450	No	200	150		300	300	No	200	125	

NOTE: When using brad nails:

- Refer to the accessories page for brad nails options.

NOTE: Off-stud cavity installation



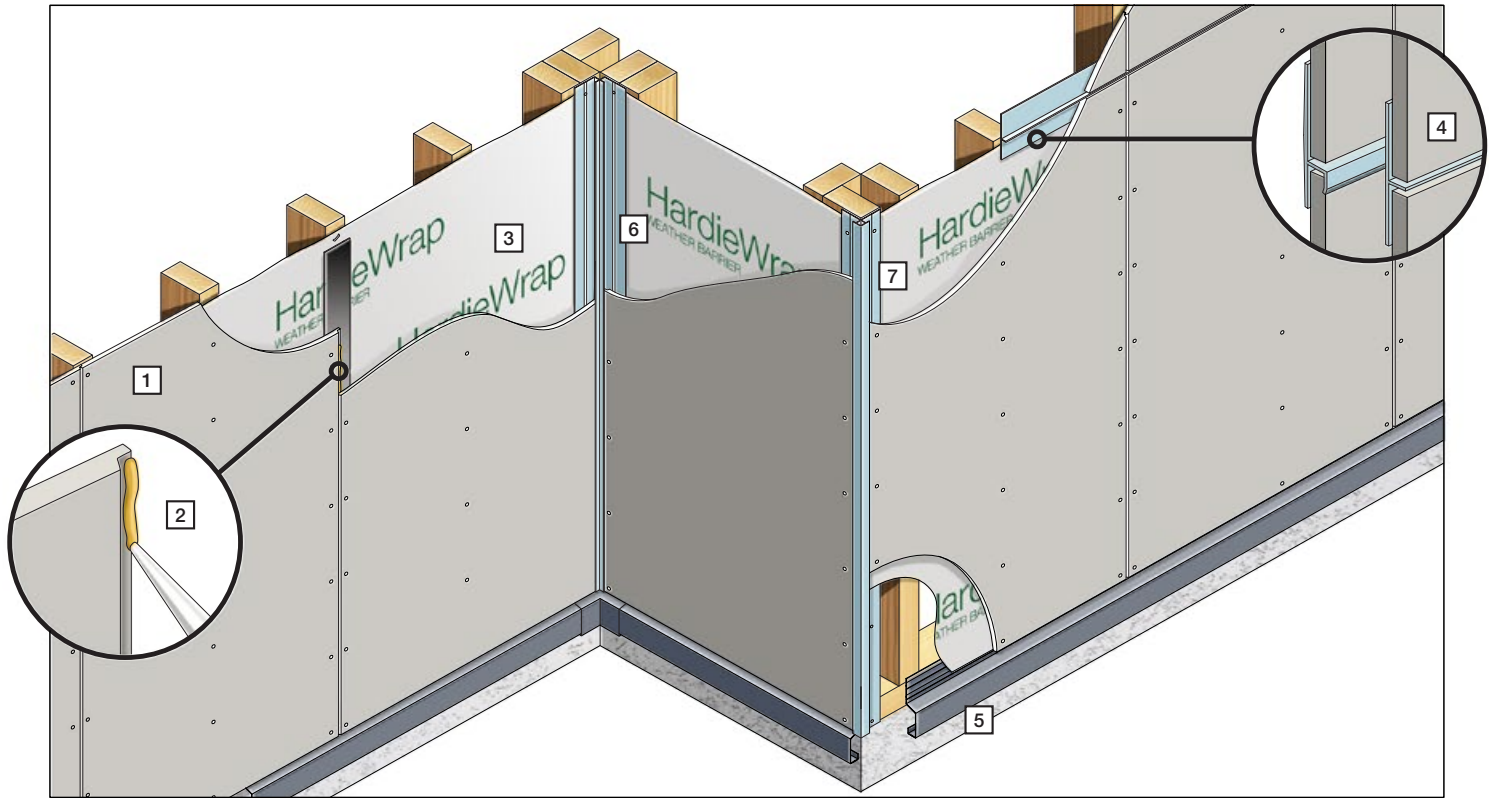

- When fixing Scyon Cavity Trims offstud, noggings must be spaced at 800mm maximum.



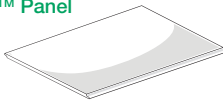
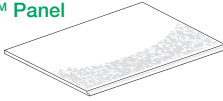

4 Products and Accessory Details

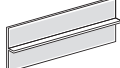
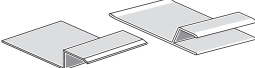

COMPONENTS

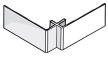
1 EasyLap™ and EasyTex™ Panels (8.5mm thick)		Product Code	Length (mm)	Width (mm)	Mass (kg)	Pack Size
EasyLap™ Panel  <p>Pre-primed sheet with a ship lap edge joint along the two vertical edges.</p>		404186	3000	900	33	40
		404184	2440	1200	36	40
		404185	3000	1200	44	40
		404980	3600	1200	52	30
EasyTex™ Panel  <p>Pre-primed textured sheet with a ship-lapped V-Groove joint along the two vertical edges.</p>		405123	2440	1200	36	40
		405124	3000	1200	44	40
		405121	3000	1350	49	30
		405125	3600	1200	52	30

Horizontal flashing options				
2 James Hardie™ Joint Sealant  <p>General purpose polyurethane exterior grade joint sealant. Pack Size: 20/Box. Product Code: 305534 300ml Cartridge Product Code: 305672 600ml Sausage Coverage: 2.67m/100ml (5mm dia bead)</p>	3 HardieWrap™ Weather Barrier  <p>High water barrier and vapour permeable membrane. Unit size: 2.75 x 30m. Pack Size: 1 Each. Product Code: 305664 Coverage: 85.5m² per roll</p>	4 James Hardie™ Horizontal T Flashing  <p>Aluminium extrusion used along horizontal control joints. Product Codes: T flashing 3000mm (5/pack) 306040 Coverage: Length of horizontal joints / 3000mm</p>	4 James Hardie™ Horizontal h Flashing  <p>Aluminium extrusion used along horizontal control joints. Product Codes: h flashing 3000mm (5/pack) 305613 h flashing jointer (10/pack) 305614 Coverage: Length of horizontal joints / 3000mm</p>	5 HardieEdge™ Trim  <p>Powder coated aluminium architectural slab edge solution. Product Codes: HardieEdge™ Trim (4/pack) 305911 Base Trim Jointer (12/pack) 305912 Internal Corner (4/pack) 305913 External Corner (4/pack) 305914</p>

Alternative corner options			
6 James Hardie™ 9mm Internal Corner  <p>Aluminium extrusion to be used in internal corners. 3000mm long. Pack Size: 5 Product Code: 305520 Coverage: Height of wall x no. of internal corners / 3000mm</p>	7 James Hardie™ 9mm External Corner  <p>Aluminium extrusion to be used in external corners. 3000mm long. Pack Size: 5 Product Code: 305521 Coverage: Height of wall x no. of external corners / 3000mm</p>	James Hardie™ Corner Flashing  <p>A corner flashing, manufactured using COLORBOND® steel, used behind cladding at internal and external corners. 75 x 75mm. 3000mm long. Pack Size: 5. Product Code: 305564 Coverage: Height of clad walls x no. of corners / 3000mm</p>	Scyon™ Axent™ Trim  <p>Material composite trim used for box corners and for trim around windows and doors. Pack Size: 1. For internal corners: 45 x 38mm. 4200mm long. Product Code: 403626 For external corners: 45 x 19mm. 4200mm long. Product Code: 404662</p>

4 Products and Accessory Details cont.

FASTENERS, BATTENS AND TAPES

EasyLap™ and EasyTex™ panels can be fixed either to timber or steel frames, which can be done directly or over Scyon™ cavity trim. Depending on the fixing method and substructure, there will be different components required, these are:

DIRECT FIX - TIMBER FRAME

	8 James Hardie™ Foam Back Sealing Tape Installed under sheet vertical joints to improve water tightness. 50mm wide 25mtr long roll. Pack Size: Each Product Code: 304560	9 Fibre Cement Nail* 2.8 x 30mm corrosion resistant fibre cement nail for fixing EasyLap™ or EasyTex™ panels onto timber stud frame. Not supplied by James Hardie™.	Gun Nail* 2.8 x 40mm minimum class 3 nail with a minimum 6mm head diameter to be used with gun nails. Not supplied by James Hardie™.	ND 50mm Stainless Steel Brad Nail* 14 gauge x 50mm ND 304 stainless steel nail for fixing EasyLap™ or EasyTex™ panels to timber framing. Not supplied by James Hardie™.
--	--	--	---	--

DIRECT FIX - STEEL FRAME

	10 HardieBreak™ Thermal Strip Refer to the HardieBreak™ Thermal Strip install guide. NCC requirement used behind external cladding when fixed directly to steel frame. Size: 43 x 12 x 2750mm. 45 per pack. Product Code: 305612	11 HardieDrive™ Screw 41mm long* A class 3 self-tapping wing-tipped screw for fastening to 0.5mm to 1.6mm BMT light gauge steel frames. 1000 per box. Product Codes: 305984 (loose) 305982 (collated)
--	--	--

CAVITY FIX - TIMBER FRAME

	12 Scyon™ Cavity Trim Fibre cement trim used to fix external cladding to steel or timber frame. Size: 70 x 19 x 2450mm. Pack Size: 96 Product Code: 403840	13 Gun Nails to fix trim to frame* 2.8 x 65mm long ring shank nail or 75 x 2.8mm D or round head galvanised smooth shank nail used to fix Scyon™ cavity trim to timber stud. Not supplied by James Hardie™.	Fastener to fix EasyLap™ and EasyTex™ to Scyon™ Cavity Trim		14 25mm DA Brad Nails* 25mm DA 16 gauge 304 stainless brad nails. Not supplied by James Hardie™.	14 Fibre Cement Nail* 2.8 x 30mm corrosion resistant fibre cement nail. Not supplied by James Hardie™.
--	--	--	---	--	--	---

CAVITY FIX - STEEL FRAME

Only suitable in wind classifications up to N3/C1

	12 Scyon™ Cavity Trim Fibre cement trim used to fix external cladding to steel or timber frame. Size: 70 x 19 x 2450mm. Pack Size: 96 Product Code: 403840	15 HardieDrive™ Screw 41mm long* A class 3 self-tapping wing-tipped screw for fastening to 0.5mm to 1.6mm BMT light gauge steel frames. 1000 per box. Product Codes: 305984 (loose) 305982 (collated)	Fastener to fix EasyLap™ and EasyTex™ to Scyon™ Cavity Trim		14 25mm Stainless DA Brad Nails* 25mm DA 16 gauge 304 stainless brad nails. Not supplied by James Hardie™.	14 Fibre Cement Nail* 2.8 x 30mm corrosion resistant fibre cement nail. Not supplied by James Hardie™.
--	--	--	---	--	--	---

Accessories

Exterior Water Based Gap Filling Agent Recommended sealers include Selleys No More Gaps - Exterior/Weatherboard or Polyfilla - Large Cracks	Epoxy Flush Sealing (2 Part) Countersunk head screws are flush filled using Megapoxy P1.
---	--

Tools

Sponge or course Utility Pad Used with recommended external based filling agent to match the EasyTex™ texture finish.	HardieBlade™ Saw Blade 185mm Diameter Poly-diamond blade for James Hardie fibre cement. Product Code: 300660 Pack Size: 1 each.	Dust-Reducing Saw with Filtered Vacuum Extraction Dust-reducing saw (Makita 5057KB or Hitachi C7YA) connected to a vacuum with HEPA filter and paper bag.
---	--	---

† All dimensions and masses are approximate and subject to manufacture tolerances.

* In coastal areas and other corrosive environments class 4 fasteners must be used. All other areas require minimum class 3.

5 Panel Installation Process* - Direct Fix

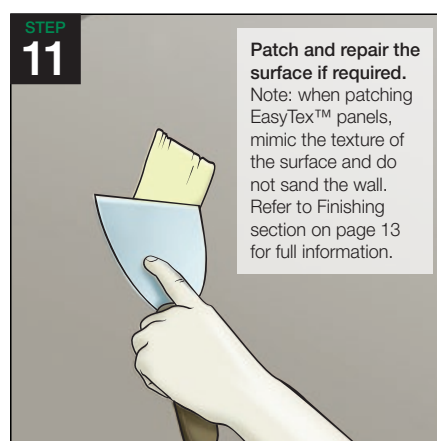
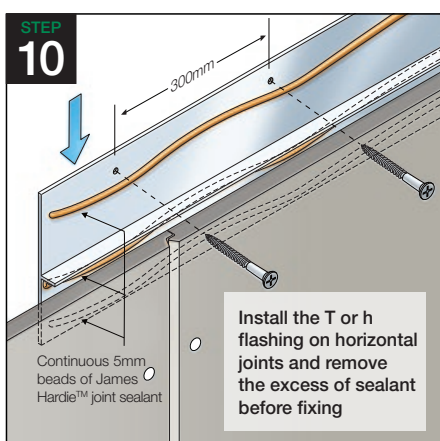
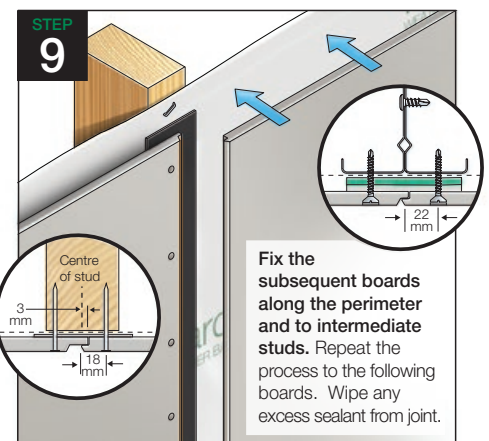
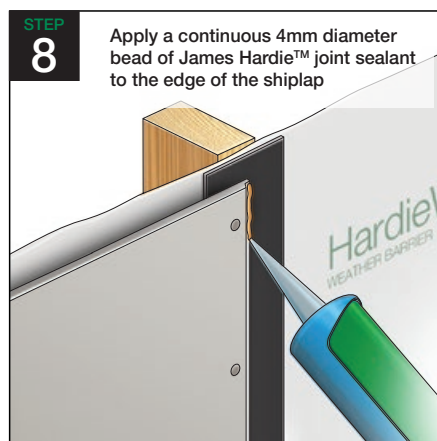
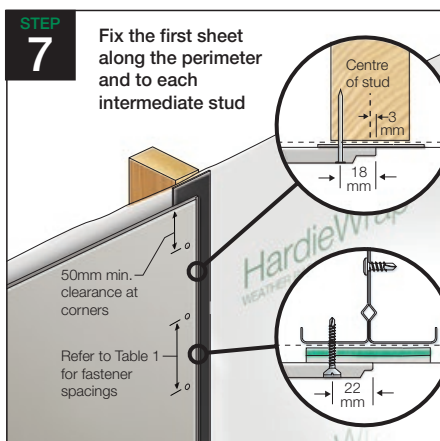
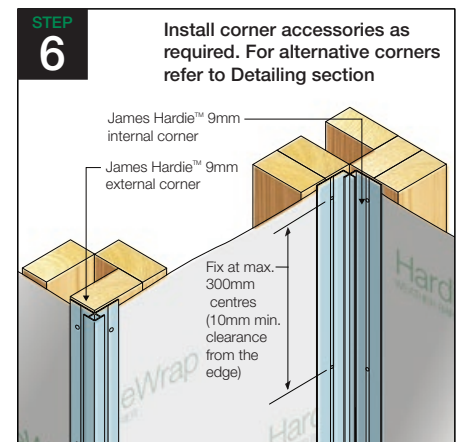
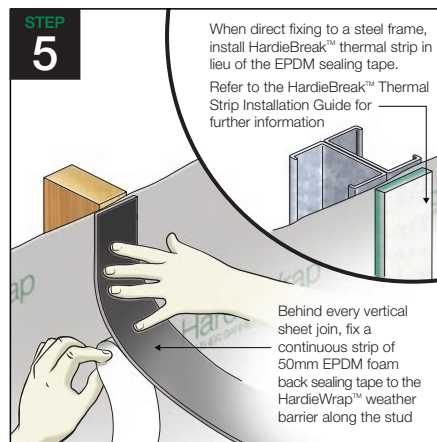
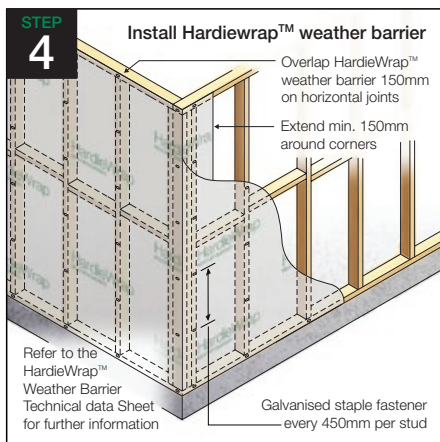
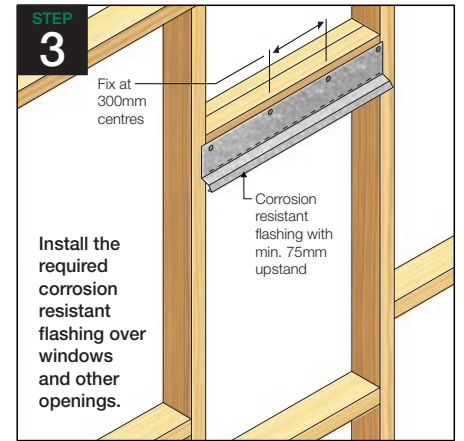
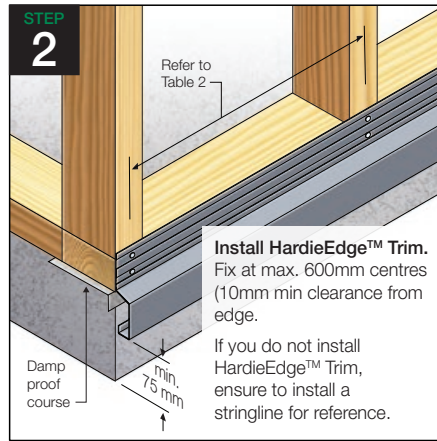
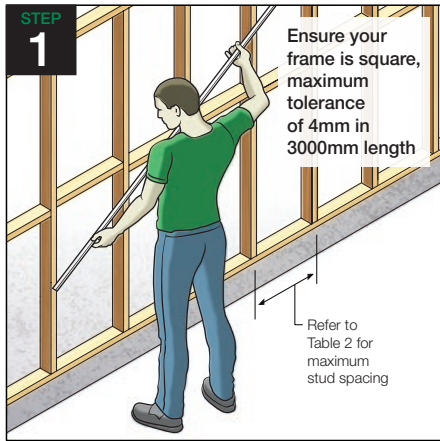

*This is an overview of the installation process only. It is not a substitute for reviewing this document in its entirety prior to installation.

6 Panel Installation Process* - Cavity Fix

STEP 1 Ensure your frame is square, maximum tolerance of 4mm in 3000mm length

Max. 800mm centres when fixing cavity trims off-stud
Refer to Table 1 for maximum stud spacing

STEP 2

Fix at 300mm centres
Corrosion resistant flashing with min. 75mm upstand

Install the required corrosion resistant flashing over windows and other openings.

STEP 3 Install Hardiewrap™ weather barrier

Overlap Hardiewrap™ weather barrier 150mm on horizontal joints
Extend min. 150mm around corners

Refer to the Hardiewrap™ Weather Barrier Technical data Sheet for further information
Galvanised staple fastener every 450mm per stud

STEP 4 Install the James Hardie™ PVC cavity vent Strip

Fix at 600mm centres maximum, with 10mm edge clearance.
min. 150mm
10mm
James Hardie™ PVC cavity vent mitred at corners and kept clear of debris. Do not insert Scyon™ cavity trim into the vent strip
Damp proof course

STEP 5 Install the cavity trims (must be fixed off-stud in steel frames)

45° cut
James Hardie Joint Sealant
50
50
Scyon™ cavity trim
20 mm min.
Refer to Table 2 for fastener spacing

STEP 6 Install corner accessories as required. For alternative corners refer to Detailing section

James Hardie™ 9mm internal corner
Scyon™ cavity trim
James Hardie™ 9mm external corner
Fix at max. 300mm centres (10mm min. clearance from the edge)

STEP 7 Fix the first sheet along the perimeter and to each intermediate stud

50mm min. clearance at corners
Refer to Table 1 for fastener spacings
18 mm

STEP 8 Apply a continuous 4mm diameter bead of James Hardie™ joint sealant to the edge of the shiplap

Bead of James Hardie™ joint sealant

STEP 9 Fix the subsequent boards along the perimeter and to intermediate studs. Repeat the process to the following boards. Wipe any excess sealant from joint.

18 mm

STEP 10

300mm
Continuous 5mm beads of James Hardie™ joint sealant
T or h flashing on horizontal joints and remove the excess of sealant before fixing

STEP 11

Patch and repair the surface if required.
Note: when patching EasyTex™ panels, mimic the texture of the surface and do not sand the wall. Ensure to refer to Finishing section on page 13 for full information.

STEP 12

Paint the wall within 3 months of being fixed or within 7 days if located within 1 km of a coastal area or corrosive environment

EasyLap™ must be painted with roll on textured paint.
EasyTex™ to be painted with exterior acrylic paint.
Refer to Finishing section on page 13 for more information.

*This is an overview of the installation process only. It is not a substitute for reviewing this document in its entirety prior to installation.

7 Construction Details - Direct Fix

JUNCTION DETAILS

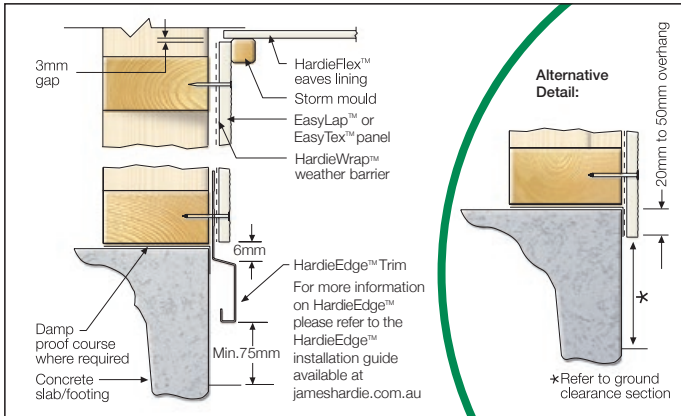

FIGURE 1 SLAB/EAVE JUNCTION DETAIL

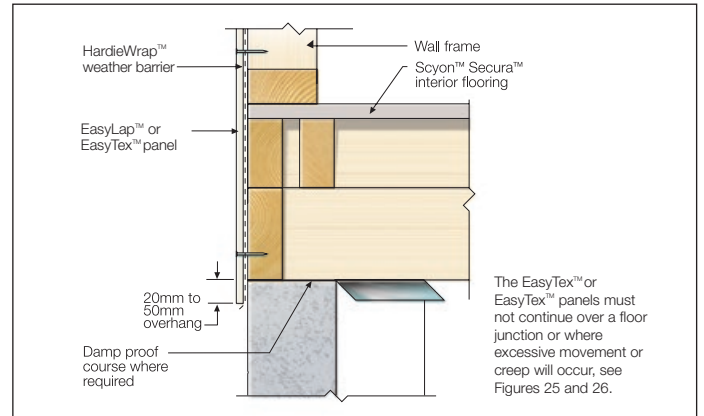

FIGURE 2 LOWER FLOOR JUNCTION

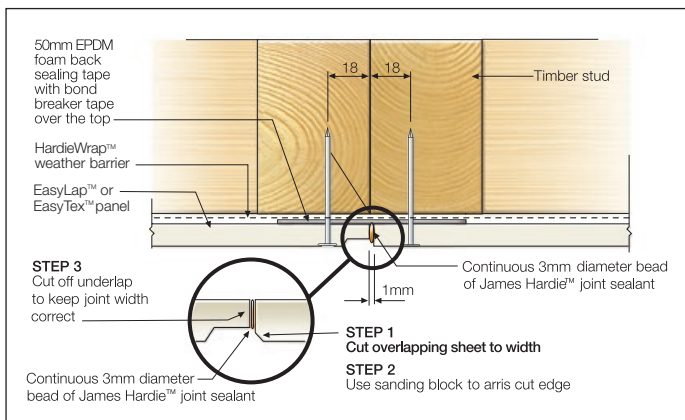

FIGURE 3 VERTICAL BUTT JOINT

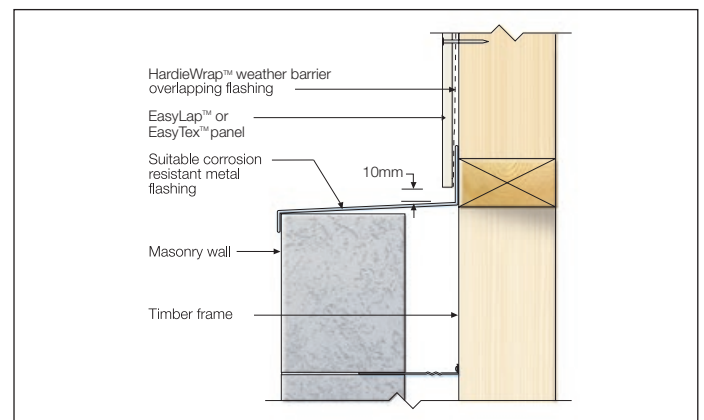

FIGURE 4 HORIZONTAL JUNCTION 2

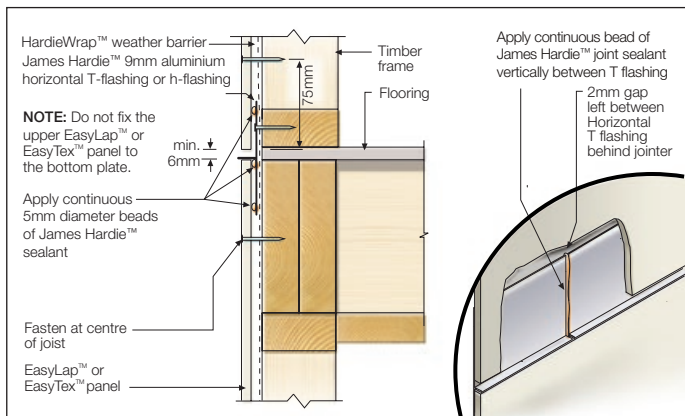

FIGURE 5 UPPER FLOOR JUNCTION OPTION 1

NOTE: Join the James Hardie 9mm Aluminium Horizontal h flashings on intermediate studs and not off stud or behind sheet joints.

EXTERNAL CORNER DETAILS

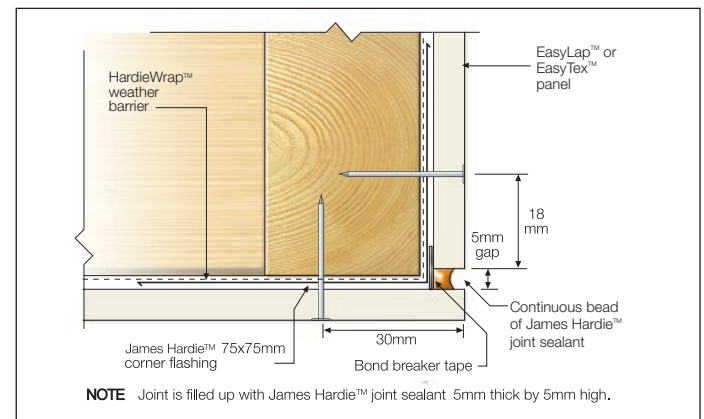

FIGURE 6 SEALANT FILL OPTION

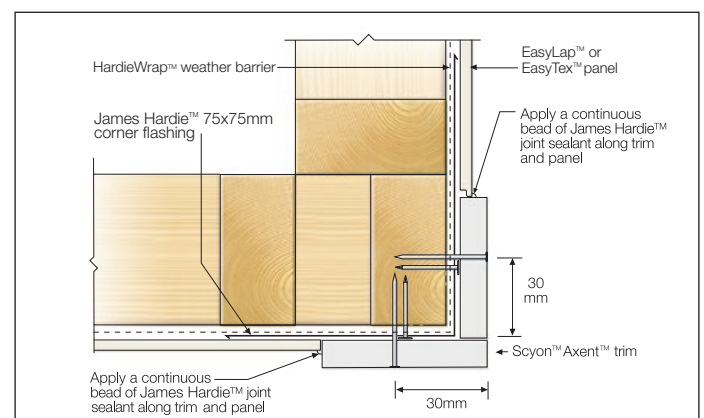

FIGURE 7 TRIM CORNER OPTION

INTERNAL CORNER DETAILS

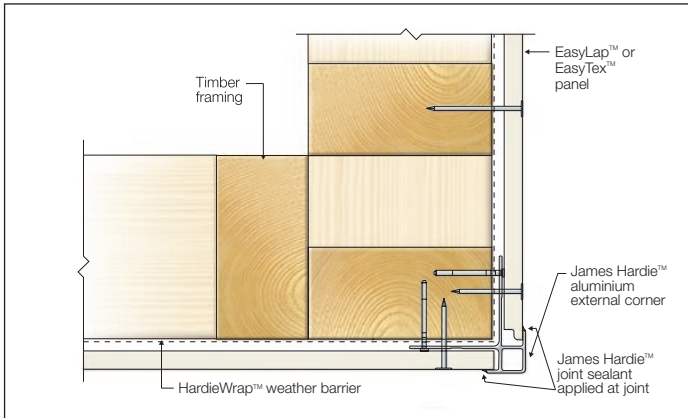

FIGURE 8 ALUMINIUM BOX CORNER OPTION

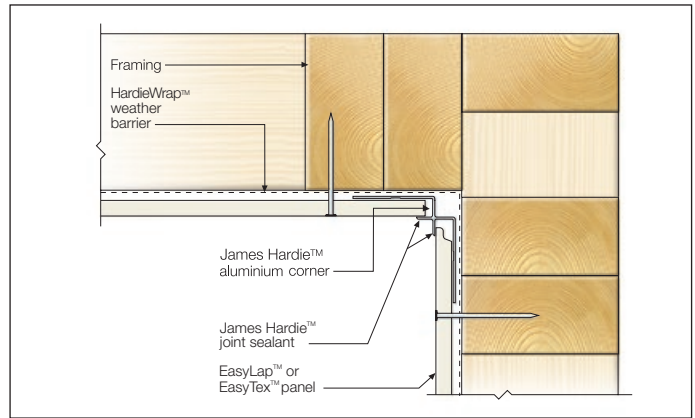

FIGURE 9 ALUMINIUM CORNER DETAIL

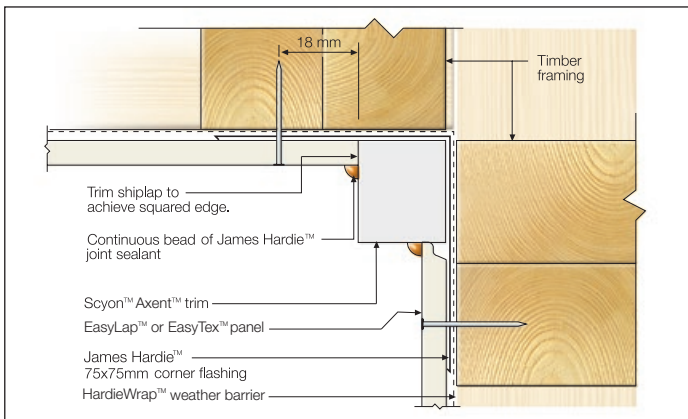

FIGURE 10 TRIM CORNER OPTION

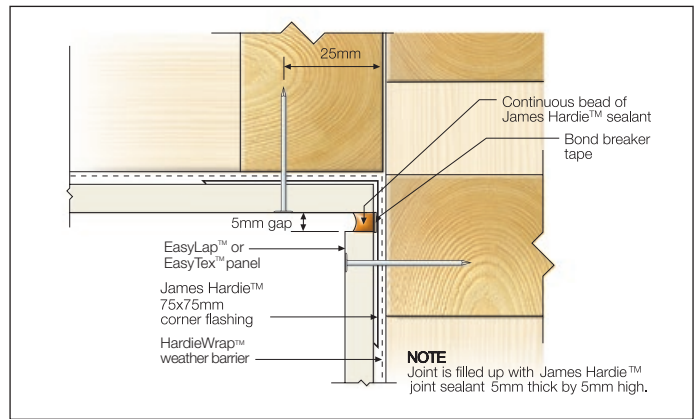

FIGURE 11 SEALANT FILL OPTION

WINDOW DETAILS

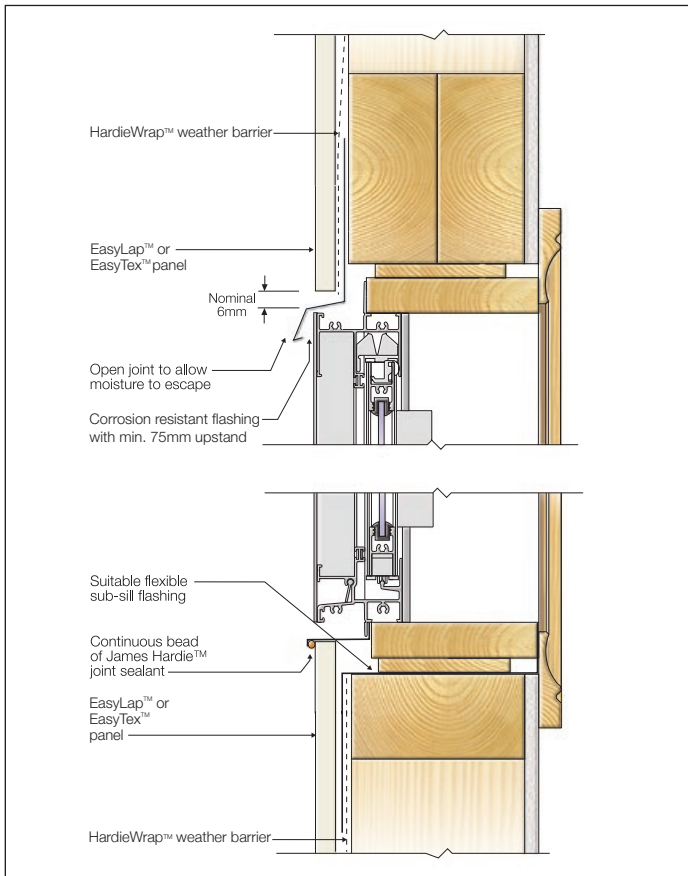

FIGURE 12 WINDOW HEAD AND SILL - TRIM

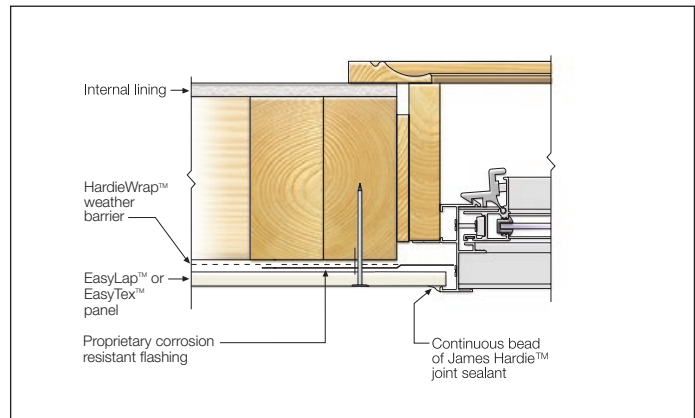

FIGURE 13 WINDOW JAMB - TRIM

8 Construction Details - Cavity Fix

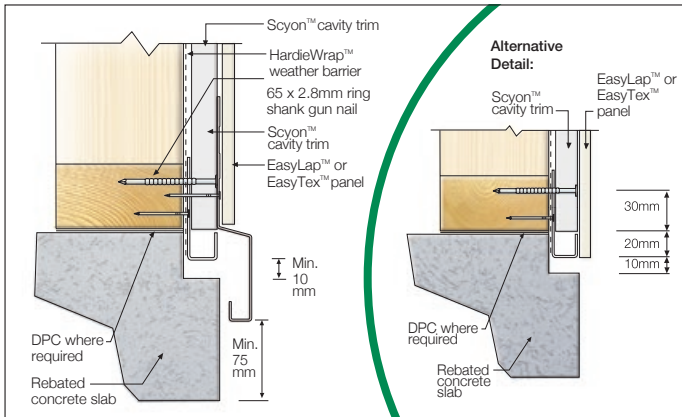

FIGURE 14 ALTERNATIVE SLAB EDGE DETAILS

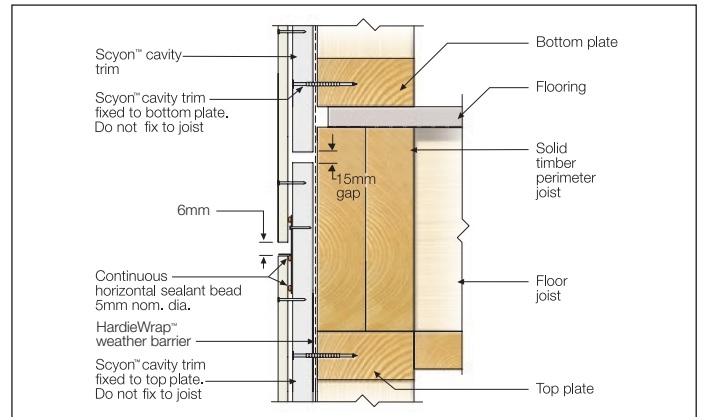

FIGURE 15 FLOOR LEVEL JUNCTION

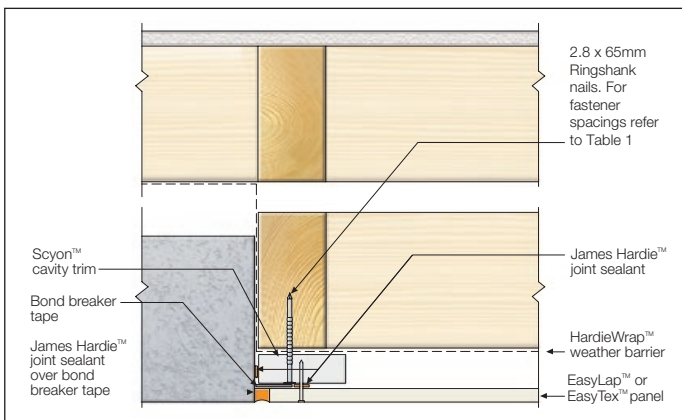

FIGURE 16 ABUTMENT DETAIL

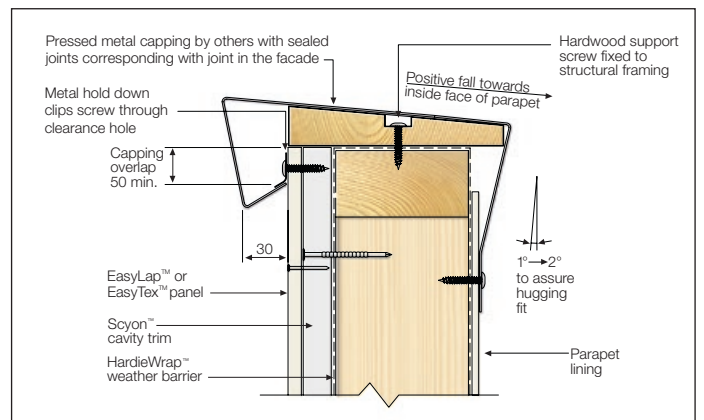

FIGURE 17 PARAPET CAPPING DETAIL

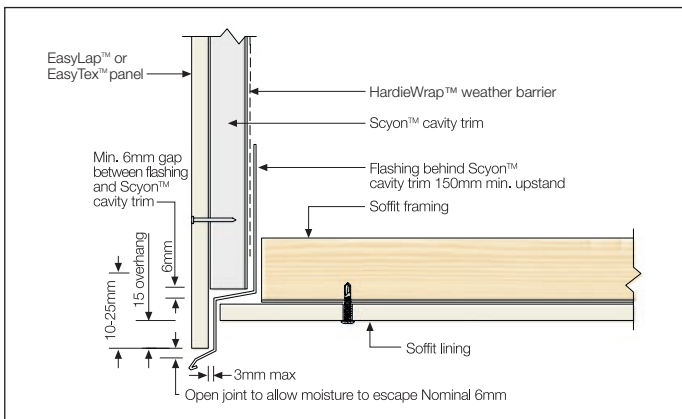

FIGURE 18 FACADE/SOFFIT JUNCTION

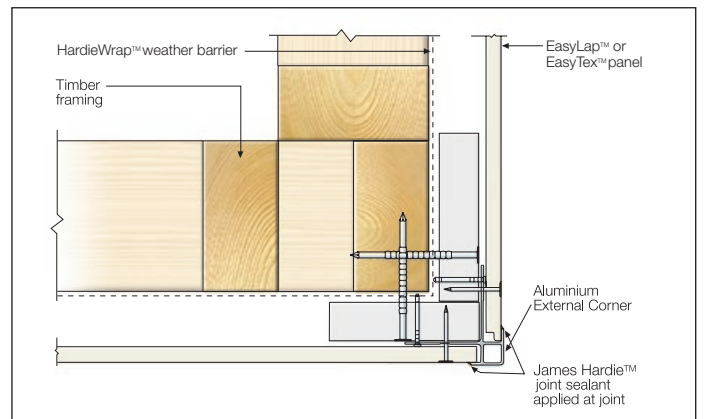

FIGURE 19 ALUMINIUM BOX CORNER OPTION - CAVITY TRIM

EXTERNAL CORNER DETAILS

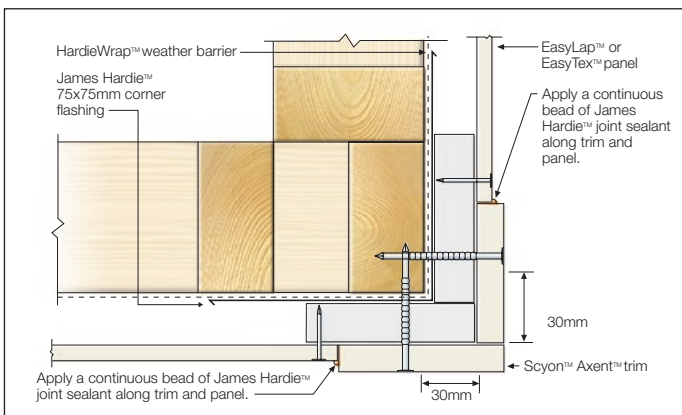

FIGURE 20 TRIM CORNER OPTION - CAVITY TRIM

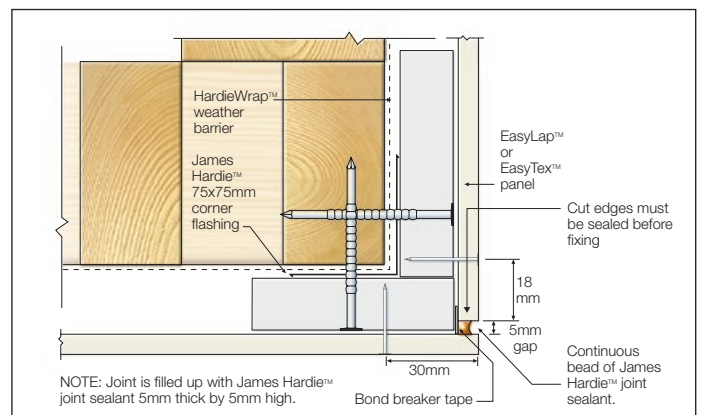

FIGURE 21 SEALANT FILL OPTION - CAVITY TRIM

INTERNAL CORNER DETAILS

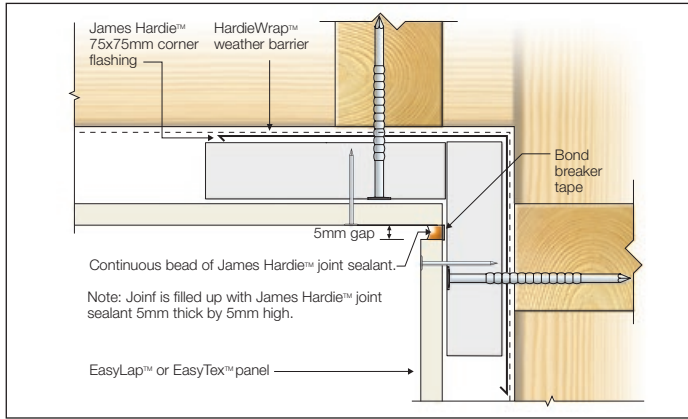

FIGURE 22 SEALANT FILL OPTION - CAVITY TRIM

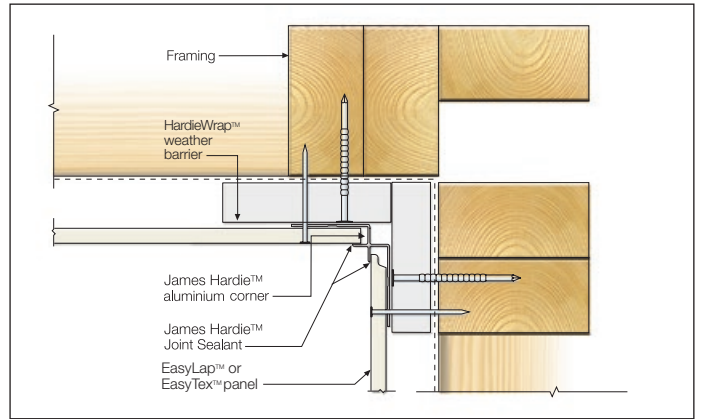

FIGURE 23 ALUMINIUM CORNER DETAIL - CAVITY TRIM

WINDOW DETAILS

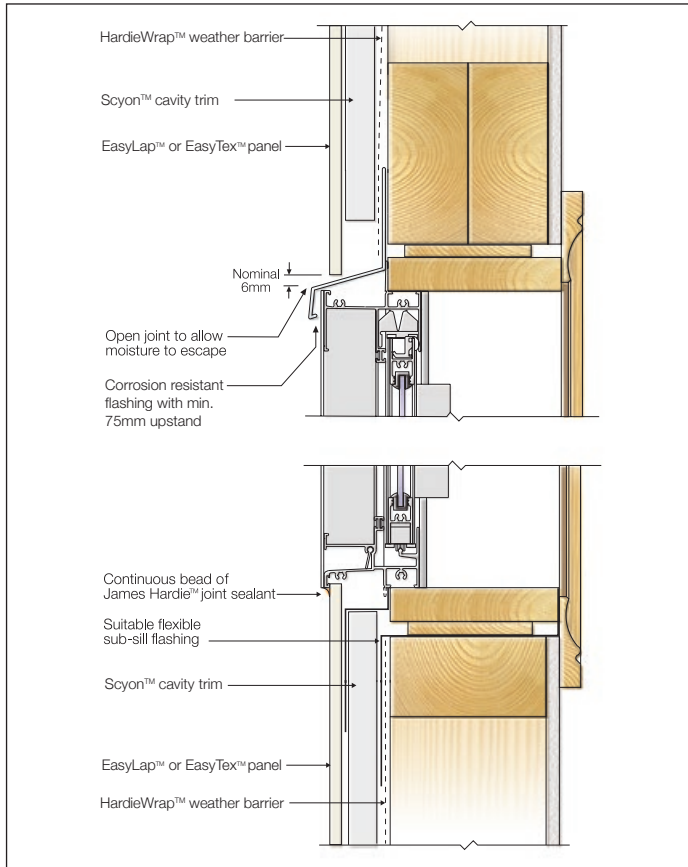

FIGURE 24 WINDOW HEAD AND SILL - CAVITY TRIM

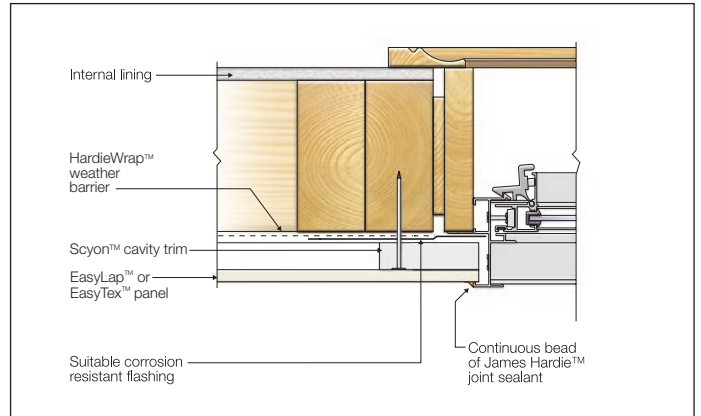

FIGURE 25 WINDOW JAMB - CAVITY TRIM

9 Finishes and Maintenance

FINISHING

Sealant

Application and use of sealants must comply with manufacturer's instructions. Sealants, if coated, must be compatible with the paint system.

PAINTING

EasyLap™ Panel

EasyLap™ panels are ready for texture. All sheets must be dry before painting.

Refer to the project specification for paint requirements. EasyLap™ panels must be finished with texture paint within 3 months of being fixed. In areas within 1km of a coastal area or corrosive environment, the EasyLap™ panels must be painted immediately after fixing sheets to minimise contamination build up on the heads of the fasteners, as it may lead to fastener corrosion.

James Hardie™ recommends the application of a roll on exterior texture coat system over the panels in accordance with the paint manufacturer's specifications. Some environments require special coatings including coastal areas. Painting selection and specifications are dependant on the paint chosen. Refer to Dulux, Taubmans or Wattyl for further information, product suitability, specifications, maintenance and details of their warranty.

EasyTex™ Panel

Any slightly overdriven brad nails (1mm max.) may be repaired using a suitable external grade filling agent and blended with the surrounding texture using a sponge or utility pad if required. EasyTex™ panels must be dry before painting.

Refer to the project specification for paint requirements. EasyTex™ panels must be finished with a quality exterior acrylic paint within 3 months of being fixed. In areas within 1km of a coastal area or corrosive environment, the EasyTex™ panels must be painted immediately after fixing sheets to minimise contamination build up on the heads of the fasteners, as it may lead to fastener corrosion.

James Hardie recommends the application of a quality exterior acrylic paint over the panels in accordance with the paint manufacturer's specifications. A suitable nap roller of 12mm or greater is recommended for optimal finish.

Staining

Stains containing linseed oil are specifically designed for wood and may not be suitable for James Hardie™ cladding products, primed or un-primed.

Semi-transparent stains can vary in uniformity of appearance depending on method of application and conditions and will require a high level of skill and craftsmanship to achieve a uniform appearance. Clear coats have not proven durable in exterior exposure and James Hardie™ considers them a maintenance item that may require application of a refurbishing sealer at regular intervals. James Hardie does not warrant the appearance or durability of semi-transparent stains and clear coats.

MAINTENANCE

The extent and nature of maintenance will depend on the geographical location and exposure of the building. As a guide, it is recommended that basic normal maintenance tasks shall include but not be limited to:

- Washing down exterior surfaces every 6-12 months*
- Periodic inspections should be made to ensure fasteners are adequately securing the sheets to framing.
- Re-applying of exterior protective finishes*
- Maintaining the exterior envelope and connections including joints, penetrations, flashings and sealants that may provide a means of moisture entry beyond the exterior cladding.
- Cleaning out gutters, blocked pipes and overflows as required.
- Pruning back vegetation that is close to or touching the building.

*Refer to your paint manufacturer for washing down and recoating requirements related to paint performance.

10 Product Information

PRODUCT INFORMATION

Material

The basic composition of James Hardie™ building products is Portland cement, ground sand, cellulose fibre, water and proprietary additives.

James Hardie™ building products are manufactured to AS/NZS 2908.2 'Cellulose-Cement Products-Flat Sheet'. These are also compliant with equivalent standard ISO 8336 'Fibre-cement flat sheets - Product specification and test methods'. For product classification refer to the relevant Physical Properties Data Sheet.

Durability

Resistance to Moisture/Rotting

EasyLap™ and EasyTex™ panels have demonstrated resistance to permanent moisture induced deterioration (rotting) by passing the following tests in accordance with AS/NZS 2908.2:

- Water permeability (Clause 8.2.2)
- Heat rain (Clause 6.5)
- Warm water (Clause 8.2.4)
- Soak dry (Clause 8.2.5)

Resistance to fire

The EasyLap™ and EasyTex™ panel is suitable where non-combustible materials are required in accordance with C1.9 of the National Construction Code (NCC).

James Hardie™ building products have been tested by CSIRO in accordance with AS/NZS 3837 and are classified as conforming to Group 1 material (highest and best result possible), with an average specific extinction area far lower than the permissible 250m²/kg, as referenced in Specification C1.10a of the National Construction Code (NCC).

Resistance to Termite Attack

Based on testing completed by CSIRO Division of Forest Products and Ensis Australia James Hardie™ building products have demonstrated resistance to termite attack.

Alpine Regions

In regions subject to freeze/thaw conditions, all James Hardie fibre cement external cladding must be installed and painted in the warmer months of the year where the temperature does not create freeze and thaw conditions or paint issues. The cladding must be painted immediately after installation. In addition, fibre cement cladding must not be in direct contact with snow and/or ice build up for extended periods, e.g. external walls in alpine regions subject to snow drifts over winter.

Furthermore, a reputable paint manufacturer must be consulted in regards to a suitable product, specifications and warranty. The paint application must not be carried out if the air temperature or the substrate temperature is outside the paint manufacturer's recommendation including the specified drying temperature range

James Hardie™ external cladding products are tested for resistance to frost in accordance with AS/NZS 2908.2 Clause 8.2.3.



**For information and advice
call 13 11 03 | jameshardie.com.au**

Australia November 2019



© 2019 James Hardie Australia Pty Ltd ABN 12 084 635 558
™ and ® denote a trademark or registered mark owned by James Hardie Technology Limited.