

HUME HOW TO

Video Instructions for
how to install a cavity unit



100% Australian Owned

QR
CODE 

WATCH VIDEO



Scan QR code for D.I.Y video or visit Hume How To on our website:
www.humedoors.com.au/hume-how-to-install-a-cavity-door.php

EVOLUTION Cavity Unit

INSTALLATION INSTRUCTIONS

www.humedoors.com.au

Components supplied with cavity unit

1 x head/ track
1 x Timber pelmet cover trim (to be cut to size).
Assorted screws

Component pack including:

2 x 4 wheel assemblies
2 x base plates
1 x bumper stop
1 x adjusting spanner
1 x Left hand door guide
1 x Right hand door guide

Includes – closing jamb (VIC. SA. TAS. WA)

Excludes – closing jamb (QLD. NSW. ACT)

Excludes – door and door furniture

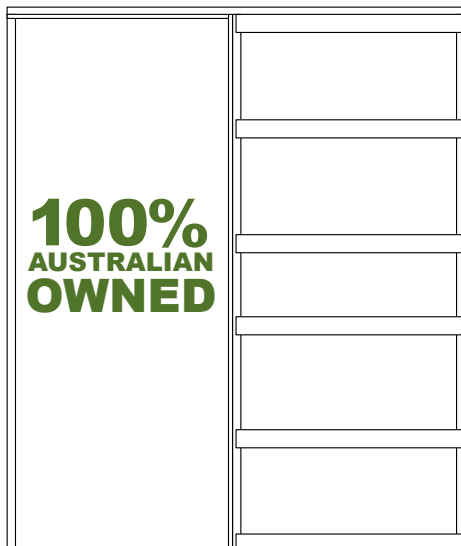

Contact Details

Sydney (NSW)
Head Office & Showroom
120 Hume Highway
Lansvale 2166
Ph: (02) 9794 1111
Fax: (02) 9794 1199

Brisbane (QLD)
86 Mudgee Street
Kingston 4114
Ph: (07) 3489 6200
Fax: (07) 3489 6299

Melbourne (VIC)
33 Remington Drive
Dandenong South 3175
Ph: (03) 9799 6888
Fax: (03) 9799 9688

Adelaide (SA)
89 Heaslip Road
Burton 5110
Ph: (08) 8280 2000
Fax: (08) 8280 8099

Perth (WA)
75 Briggs Street
Carlisle 6101
Ph: (08) 9470 1800
Fax: (08) 9472 3802

www.humedoors.com.au

Prepare the opening

Unit size is tight, please allow extra for packing when preparing the opening.

Height = Door height + 70mm (QLD. VIC. SA. TAS. WA)

Height = Door height + 80mm (NSW. ACT)

Opening width for Flush pull = 2 x Door + 10mm

(Flush pull the door protrudes 50mm)

Opening width for Flush jamb = 2 x Door + 60mm

(Flush jamb the door is flush with split jamb)

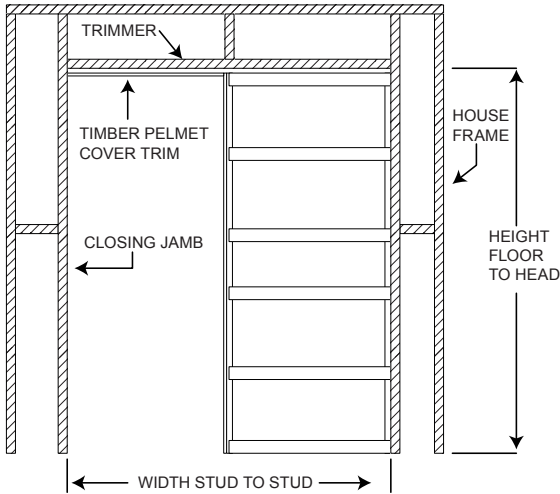

1. Installing the cavity

1.1 Fit and screw steel head/track to top of cavity unit (after removing temporary spacer block at top).

1.2 Fix closing jamb to head/track (closing jamb is not supplied QLD. NSW. ACT).

1.3 Stand the assembled cavity unit into the prepared frame opening, make sure split jambs are plumb, (pack under cavity unit if required for additional clearance under door) then fix through back post of cavity unit into house frame.

1.4 Level the head/track and fix through into house frame.

1.5 Plumb closing jamb, pack and fix through to house frame.

IMPORTANT

At this stage make sure the temporary spacer block, (located between the split jambs, approximately half way up from the bottom) remains in place during cladding and tiling to prevent distortion of split jambs. This block should only be removed when installing the door.

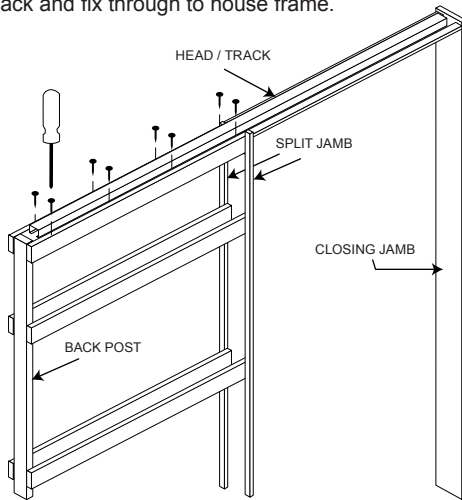

2. Door Preparation

2.1 Check the door is straight and free of any imperfections. Door must be fully sealed according to Hume Doors & Timber guarantee.

NOTE: Now would be a good time to fit any door furniture.

2.2 Attach base plates to top edge of door 80mm from each end with nylon lock tabs both on the same side of door.

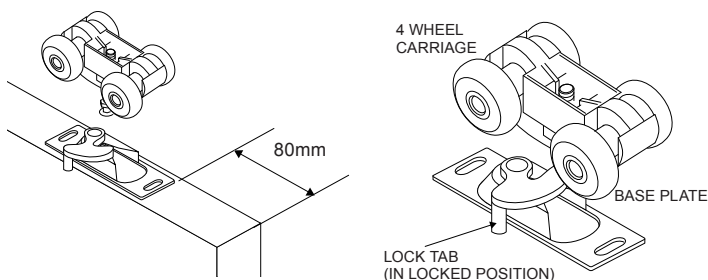

3. Installing the door

3.1 Check that no fixings or other obstructions are protruding into the cavity that may damage the door.

3.2 Fit the 4 wheel carriages into track

3.3 Slide the door into cavity, lift door and slide carriage pins into carriage base plate, then lock in with lock tab. Repeat this process for second carriage.

3.4 Using spanner supplied, adjust height and plumb against closing jamb.

3.5 Fasten door guides at the bottom of split jambs as shown and adjust until the door slides evenly and smoothly into the cavity unit.

3.6 Cut timber pelmet cover, trim to desired length, fix with screws provided.

(To remove door unscrew removable pelmet, remove door guides and unlock nylon lock tabs. Door will unclick from base plate/s).

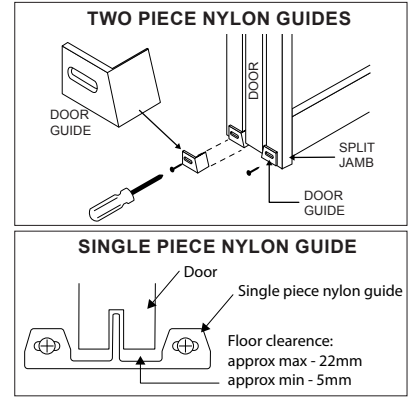
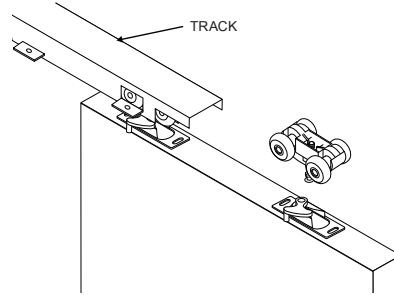

4. Double Door Installation

(double door stop supplied separately)

Unit size is tight, please allow extra for packing when preparing the opening.

Height is the same as single opening.

Width flush pull = 4 x door - 16mm

(Flush pull the door protrudes 50mm)

Width flush jamb = 4 x door + 124mm

(Flush jamb the door is flush with split jamb)

4.1 Install 2 x cavities into the opening as per the single cavity installation instructions (closing jamb not required) ensuring the 2 head/tracks are cut to correct length and butted together as shown.

4.2 Install doors as per single instructions

4.3 Install double stops into the track as shown, making sure the doors close to the centre.

4.4 Using the timber pelmet cover trims (1pc comes uncut with each single cavity) cut to span the double opening as shown, fix with screws provided.

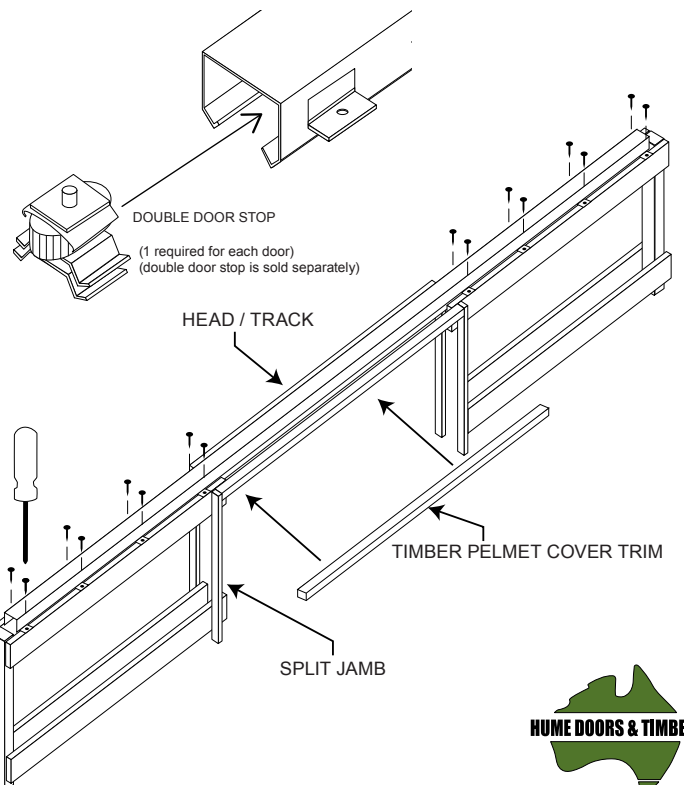

Ref: evo-05