



HUME COMMERCIAL
DOORS & FRAMES
PRECISION COMMERCIAL PRODUCTS



EXPLORE NEW OPPORTUNITIES TOGETHER

- ✓ Commercial Doors & Steel Frames
- ✓ Steel Cavity Units
- ✓ Aluminium Doors

PRODUCT CATALOGUE
Version 1.0



PRECISE PRODUCTION TECHNIQUES, CRAFTSMANSHIP AND ATTENTION TO DETAIL

Hume Commercial Doors & Frames is shaped by our relentless desire to challenge the established order. We took the key ingredients from our expertise within the door manufacturing sector and reinvented and applied them in new, innovative ways. Combined with the culture, skills, experience and enthusiasm of the people within Hume Commercial, this is the engine that drives our development.

In conjunction with strong strategic alliances with other innovative companies in the industry, we always ensure that every commercial product we produce is worthy of the Hume name.

COMMERCIAL PRODUCTS

- ✓ Fire rated and non fire rated, knockdown or assembled primed steel door frame
- ✓ Special size steel door frames
- ✓ Custom made frames to suit any requirements
- ✓ Commercial doors including: Metal clad doors, Fire doors, solid core, hollow core and all related accessories
- ✓ Speciality commercial products

STATE OF THE ART MANUFACTURING

Hume Commercial has state-of-the-art manufacturing facilities that include CAD Turret Punch, CAD Brake Press, Heated Spray Booth, Welding Bay, Door Hot Press and CNC Router — located in three strategic locations within Australia.

Together with innovative manufacturing solutions and a dedicated experienced team, the result is a precision product manufactured to specifications, every time.



CONTENTS

- 4 STEEL DOOR FRAME
- 5 NON FIRE RATED STEEL DOOR FRAME PROFILES
- 6 FIRE RATED STEEL DOOR FRAME PROFILES
- 7 SPECIAL STEEL DOOR FRAME PROFILES
- 8 FRAME FIXING METHODS FOR MASONRY WALLS
- 9 FRAME FIXING METHODS FOR DRY WALLS
- 10 STEEL DOOR FRAME CONFIGURATIONS
- 11 COMMERCIAL FIRE DOORS
- 12 SPECIALITY PRODUCTS
- 13 SPECIALITY PRODUCTS
- 14 EVOLUTION STEEL CAVITY UNITS
- 15 EVOLUTION STEEL CAVITY UNITS
- 16 ELITE DOOR RANGE
- 17 ELITE DOOR RANGE OPTIONS
- 18 STEEL DOOR FRAME WARRANTY
- 18 GUARANTEE DOORS
- 19 OUR SERVICES AND TEAM
- 20 CONTACTS



FIRE RATED

Tested and approved for use in fire rated applications. Must be installed and back filled as per Australian standards.



NON FIRE RATED

Not for use in fire rated applications.



STEEL DOOR FRAMES

STEEL DOOR FRAME

✓ 1 Year Guarantee

STEEL FRAME PROFILE DETAILS

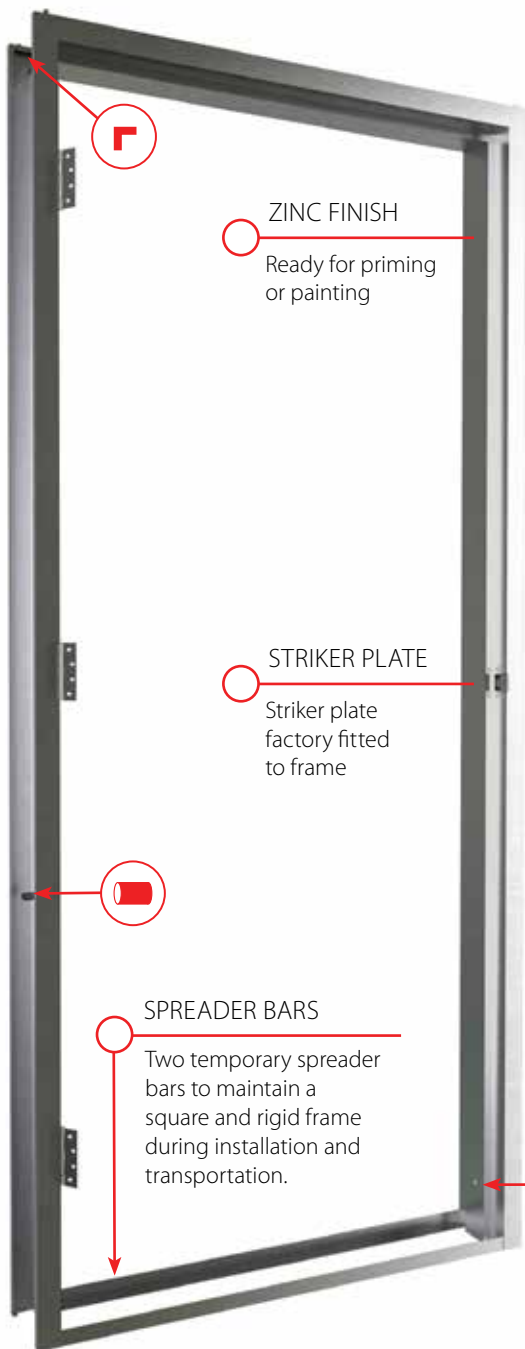
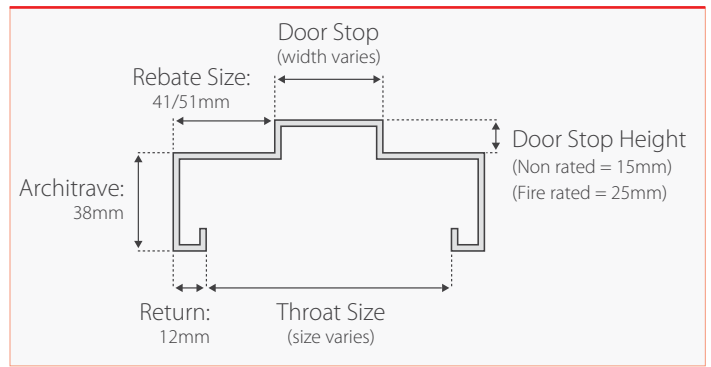

ZINC FINISH
Ready for priming or painting

STRIKER PLATE
Striker plate factory fitted to frame

SPREADER BARS
Two temporary spreader bars to maintain a square and rigid frame during installation and transportation.

COMPLETE RANGE TO SUIT EVERY APPLICATION

Our team can design and produce any type of steel door frame and will gladly accept your enquiry no matter how unusual

3 HINGES INCLUDED

Hinges are screw-fixed to the frame for easy door removal. Steel frames require 3 hinges to meet guarantee for solid doors.

CORNER DETAIL

Knock Down frame parts slot together accurately. Push lugs down to secure frame.

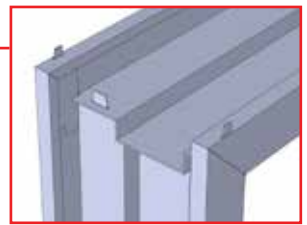

TUBE FIX

Protects the fixing hole from being blocked during the back filling of the frame. Back filling is required for fire rated applications.

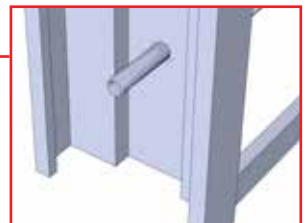

DIMPLE FIX

A countersunk hole for a mechanical anchor fixing into masonry walls.

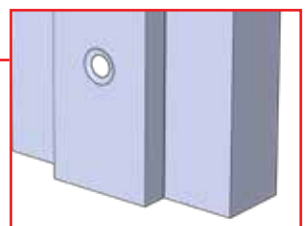

MORE FIXING SOLUTIONS

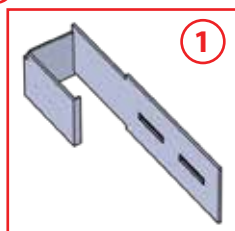
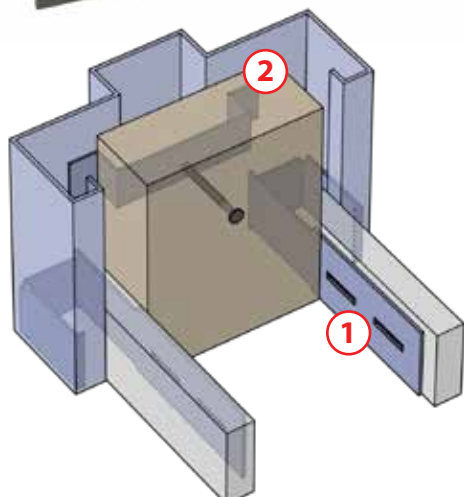

STUD CLIPS

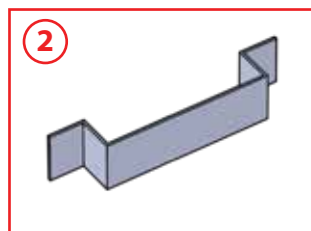

STRAP FIX

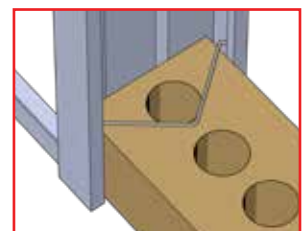

BRICK TIE

■ For information about fixing methods refer to pages 8 and 9.

FRAMES AVAILABLE WITH SINGLE OR DOUBLE RETURN



DOUBLE RETURN

Standard in all states except Victoria.

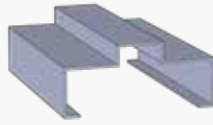

SINGLE RETURN

Standard in Victoria.

ALL FRAMES CAN BE MANUFACTURED TO SUIT:

DOOR WIDTHS:	Any size from 320mm to 1200mm
DOOR HEIGHTS:	Any size up to 3000mm
DOOR THICKNESS:	Range from 35mm to 50mm

- All frames can be adapted to suit **any required application**.
- Made to measure custom variations and sizing available.
- Frames are manufactured from 1.1mm thick steel as standard. Custom thicknesses are available.
- All diagrams shown are double return and are not to scale

STANDARD PROFILES

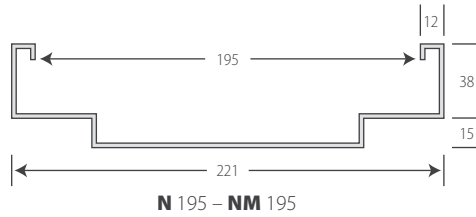
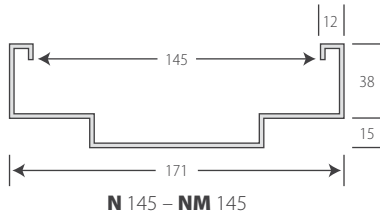
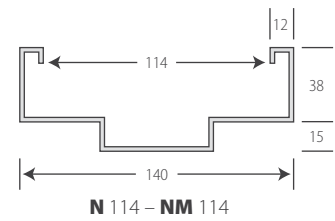
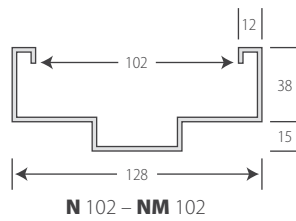
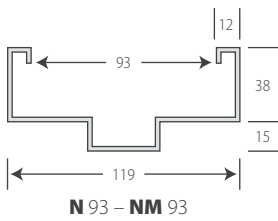

- **N:** Non fire rated frame to suit a **hinged 35mm** thick door with a rebate size of **41mm**. Stop height is 15mm.
- **NM:** Non fire rated frame to suit a **hinged 40mm** thick door with a rebate size of **45mm**. Stop height is 15mm.

NON REBATED PROFILES

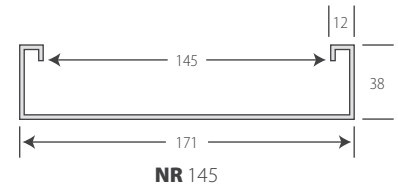
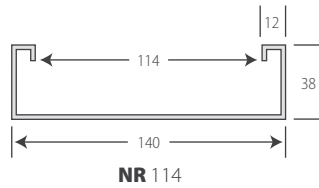
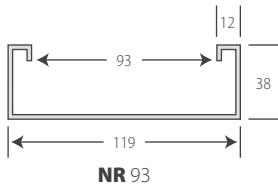

- **NR:** Non fire rated frame with **no rebate or door stop** (Suits sliding doors).

SINGLE REBATED PROFILES

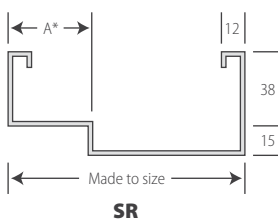

- **SR:** Non fire rated frame to suit a **hinged 35mm to 50mm** thick door. Stop height is 15mm. Rebate size varies (see table)

A* Rebate Depths:	41mm (for 35mm thick door) 51mm (for 45mm thick door)	Please note: Metal cladding will increase door thickness.
-------------------	--	---

- For Single Leaf Door Sets up to 1200mm wide, frames are manufactured from either 1.1mm or 1.4mm steel. These frames have Fire Ratings from -/60/30 to -/120/60.
- For Single Leaf Door Sets over 1200mm wide and a Fire Rating in excess of -/120/60, frames are manufactured from 1.4mm steel only.
- Masonry Walls MUST be grout-filled to comply with Australian fire rating standards.
- Frames for Masonry Walls are fixed using Wire Ties or Mechanical Anchors.
- Dry Walls MUST be filled with an approved fire retardant material to comply with Australian fire rating standards.
- Frames for Metal Stud Walls (Dry Walls) are fixed using Top Hats.
- All diagrams shown are double return and are not to scale
- For fixing method diagrams refer to pages 8 and 9.

FRAMES AVAILABLE WITH SINGLE OR DOUBLE RETURN

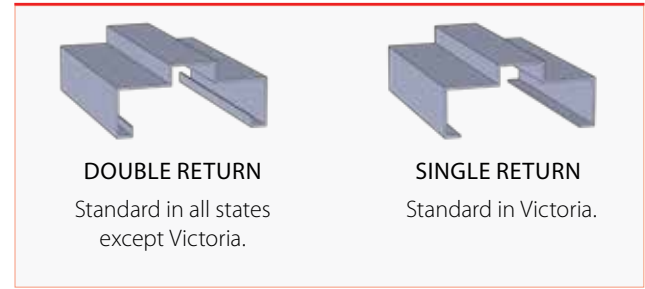

ALL FRAMES CAN BE MANUFACTURED TO SUIT:

DOOR WIDTHS:	Any size from 620mm to 1200mm
DOOR HEIGHTS:	Any size up to 3000mm
DOOR THICKNESS:	Range from 35mm or 47mm

FIRE RATED STANDARD PROFILES

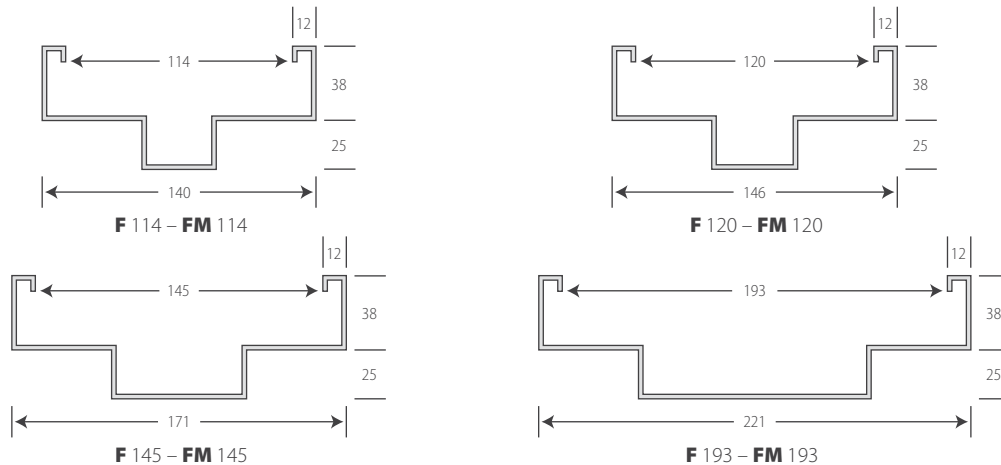

- **F:** Fire rated frame to suit a hinged 35mm to 37mm thick door with a rebate size of 41mm. Stop height is 25mm.
- **FM:** Fire rated frame to suit a hinged 45mm to 47mm thick door with a rebate size of 51mm. Stop height is 25mm.

FIRE RATED SINGLE REBATE PROFILES

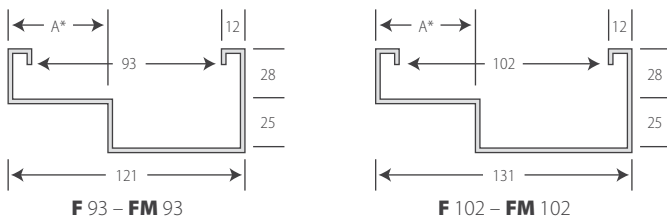

- **F/FM:** Fire Rated Single Rebated frame to suit a hinged 35mm to 47mm thick door. Stop height is 25mm. Rebate size varies (see table)

A*	41mm (for 35-37mm thick door)
Rebate Depths:	51mm (for 45-47mm thick door)
Note: Metal cladding will increase door thickness.	

FIRE RATED CONCAVE SPECIAL FOR PIVOT PROFILE

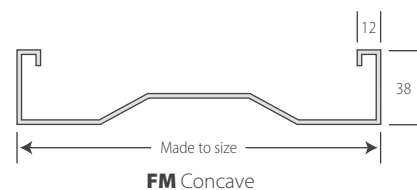

- **FM Concave:** To suit a Fire Rated Pivot 45 to 47mm thick door.



- All frames can be adapted to suit **any required application**.
- Made to measure custom variations and sizing available.
- Frames are manufactured from 1.1mm thick steel as standard. Custom thicknesses are available.
- All diagrams shown are double return and are not to scale
- For fixing method diagrams refer to pages 8 and 9.

FRAMES AVAILABLE WITH SINGLE OR DOUBLE RETURN

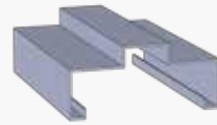

DOUBLE RETURN
Standard in all states except Victoria.

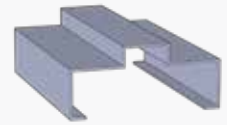

SINGLE RETURN
Standard in Victoria.

SPECIAL / ADAPTABLE PROFILES



PIVOT

Pivot frames are made to suit the style of pivot system being used. A sample of the pivot is required to ensure the frames can be manufactured correctly.



NEW GEN

The New Gen Frame has flanges on both sides that overlap the stud. The Installer screws through the flanges into the stud, the wall sheeting can be placed into the pocket to cover the fixing points. Frames can be made to suit varying wall sheeting thicknesses. Available in non fire rated and fire rated.



BRICK VENEER

A Brick Veneer frame has an extension flap offset to the back of the frame with the throat sized to accommodate the thickness of the steel wall channel or timber stud and brick/masonry wall.



BRICK VENEER NEW GEN

A Brick Veneer New Gen frame has all the benefits of the new gen frame to the side coupled with the brick veneer profile to the outside.

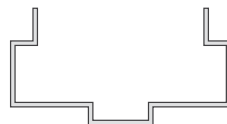

PARTITION

The Partition frame has flanges on both sides that overlap the stud. The installer screws through the flanges into the stud, the wall sheeting is placed over the fixing point to finish flush with the frame. Made to order to suit any wall sheet thickness. Available in non fire rated & fire rated.

FRAME FIXING METHODS FOR MASONRY WALLS

- Made to measure custom variations and sizing available.
- All diagrams shown are double return and are not to scale

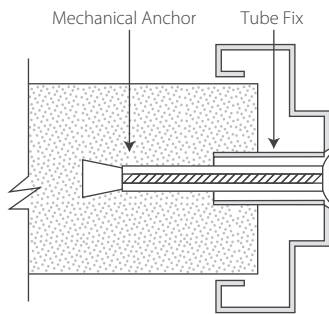

CONCRETE WALL (TUBE FIX)

Tube fix is a tube welded to the back of the countersunk hole. This protects the hole from being blocked during the backfilling of the frame (required for fire rated applications) and provides a spacer to ensure the frame does not deflect when installing with a mechanical anchor.

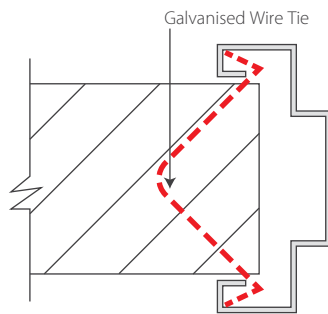

SINGLE MASONRY WALL (WIRE TIE)

A common masonry wall fixing method. A 'V' shaped tie is clipped into the back of the frame and protrudes past the frame for alignment between courses of bricks during the construction of the wall.

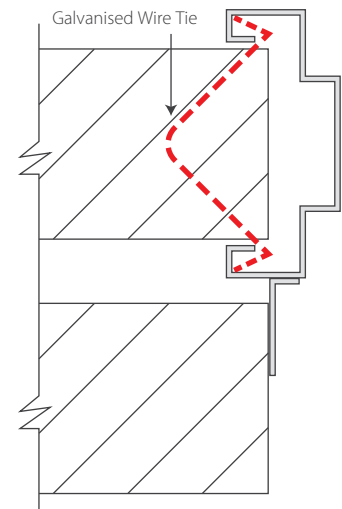

CAVITY MASONRY WALL WITH WEATHER MOULD (WIRE TIE)

This fixing uses the same method as a single masonry wall with an added 'L' shaped weather mould to cover the cavity between walls. Used when the frame is set to the inside of the opening.

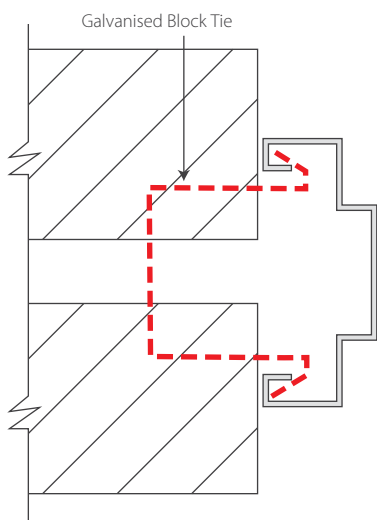

EXISTING SINGLE MASONRY WALL (COUNTERSUNK)

Countersunk holes with dimples that are formed into the frame during manufacture. Suitable for fixing off the frame to an existing opening with a mechanical anchor. Once installed the holes can be filled and painted over.

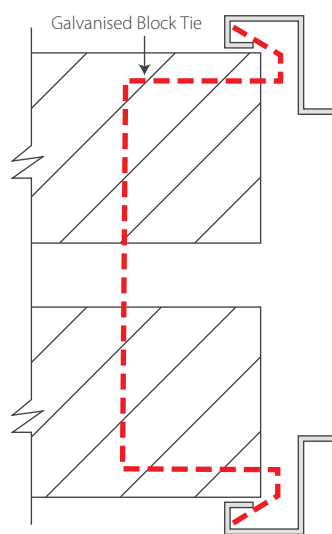

CAVITY MASONRY WALL (BLOCK TIE)

Another common wall fixing method. A 'U' shaped tie is clipped into the back of the frame and protrudes past the frame for alignment between courses of bricks during the construction of the wall. Spans across the cavity between two courses of bricks.

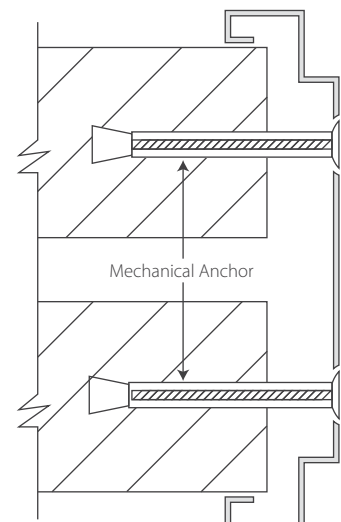
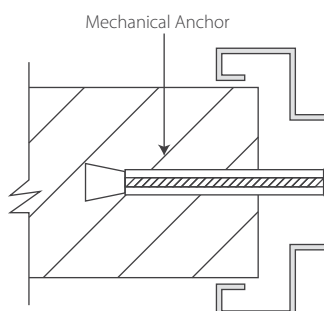

- Made to measure custom variations and sizing available.
- All diagrams shown are double return and are not to scale

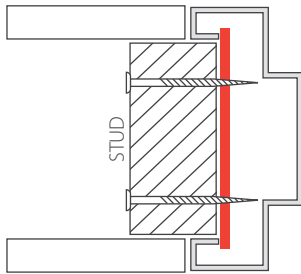

FLAT STRAP BRACE

This fixing method positions a strap to the back of the frame between the returns which allows for screwing through the wall channel or stud into the strap fixed to the back section of the frame.

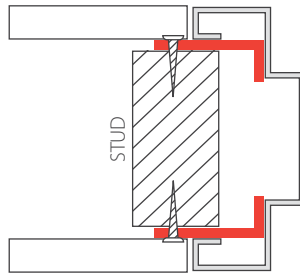

WING STRAP WELDED (FLUSH FINISH)

This fixing method positions a wing strap with wings pointing towards the stop offering superior strength. The frame can be fixed by screwing through the wing strap into the stud.

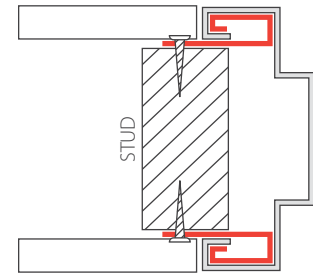

STUD CLIPS (LOOSE)

Stud clips are designed to clip into the back of the frame and protrude past the frame for fixing through the side of the wall stud. Requiring the finishing of the wall sheet to the edge of the frame as the wall sheet does not slide into the back of the frame.

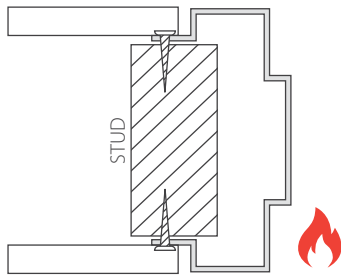

PARTITION

A Partition frame has an extension flap off the back of the frame which is the fixing section for the wall stud. Requiring the finishing of the wall sheet to the edge of the frame as the wall sheet does not slide into the back of the frame.

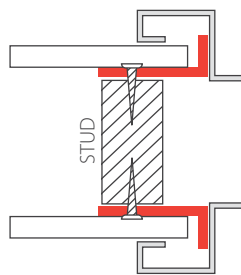

WING STRAP WELDED (CONCEALED EDGE OF WALL)

This fixing method positions a wing strap with wings pointing away from the stop offering space for the wall sheets, while provided added strength. The frame can be fixed by screwing through the wing strap into the stud.

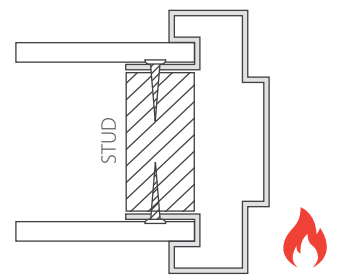

NEW GEN FRAME

The New Gen Frame is designed to hold and conceal the edge of the wall sheeting. This fixing method allows the wall sheeting to slide into the back of the frame negating the need to finish the wall sheet at the junction of the frame.

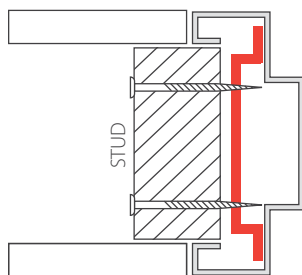

TOP HAT FIXING (FLUSH FINISH WALL)

Designed for high traffic areas offering superior strength and rigidity. This fixing method positions the top hat in the back of the frame which allows for the screwing through the wall channel or stud into the back section of the frame.

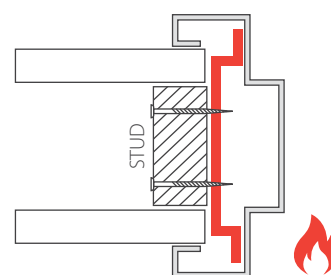

TOP HAT FIXING (CONCEALED EDGE OF WALL)

Designed for high traffic areas offering superior strength, rigidity and to comply with certain fire ratings. This fixing method positions the top hat in the back of the frame which allows for the screwing through the wall channel or stud into the back section of the frame.



STEEL DOOR FRAME CONFIGURATIONS

Our adaptability allows for a wide range of possible configurations. Please ask one of our representatives for advice with your request. The following is a guide to some typical configurations.

- All configurations are viewed from the outside. Both left or right hand openings available.
- All diagrams shown are not to scale

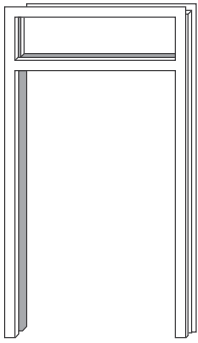

REBATED RANSOM

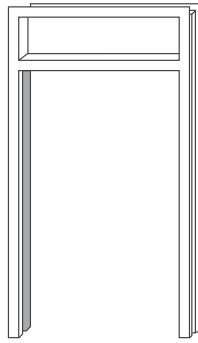

NON REBATED RANSOM

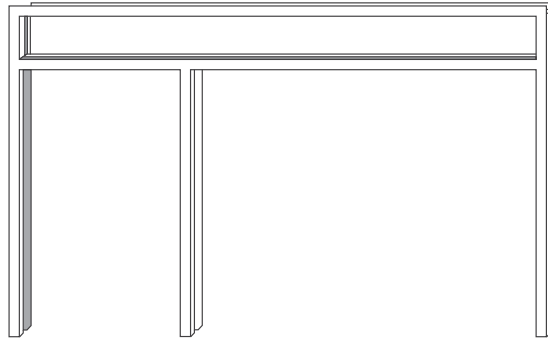

SIDE MULLION & TRANSOM

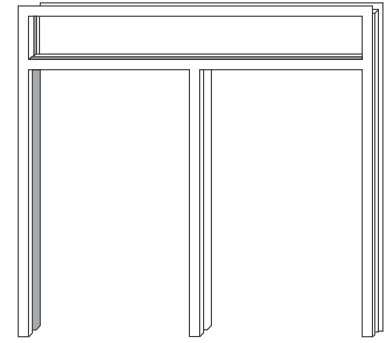

SIDE MULLION & TRANSOM

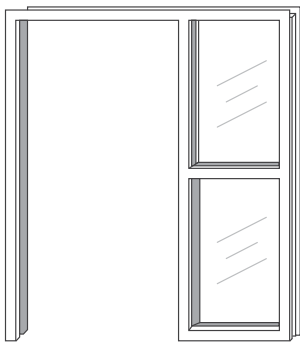

SIDELITE

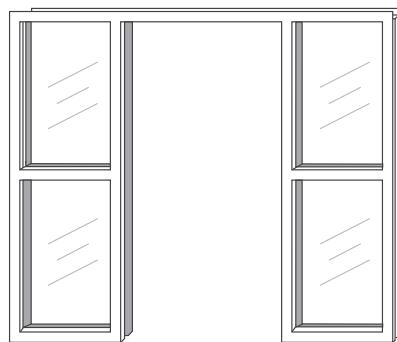

DOUBLE SIDELITE

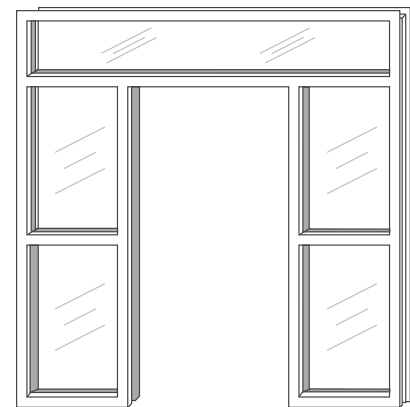

DOUBLE SIDELITE & HIGHLITE

MULLION AND TRANSOM PROFILES

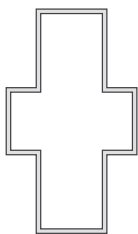

SIDE & CENTRE MULLION

A **vertical** section of a frame dividing the opening into sections between doors and sidelites.

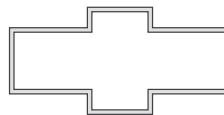

REBATED TRANSOM

A **horizontal** section of a frame dividing the opening into sections between doors and highlites.



NON REBATED TRANSOM

A **horizontal** section of a frame dividing the opening into sections between doors and highlites.



FIRE DOORS

- TVC Firecore available in 1, 2, 3 and 4 hour ratings.
- Face Materials: MDF, Ply or Tempered Hardboard.
- Vision Panels, Cladding and Air Grilles available.
- Match with fire rated steel door frames. Refer to page 6.



FIRE DOOR CONSTRUCTION

- Metal Inner Plates for Hinges, Lock and Closer.



ROBAX VISION PANEL

- Sizes: 600x100, 300x200, 450x120.



COMMERCIAL PRODUCTS



METAL CLAD DOORS

- Standard 0.9mm thick zinc. Other sizes and options available (Single side cladding voids warranty).
- Special sizes and colour options available.
- For more information refer to page 12.



ALUMINIUM T-BARS

- Available to suit both fire rated and non fire rated doors.



AIR GRILLES

- Available to suit both fire rated and non fire rated doors.



REDISET JAMB PROFILES

RediSet solutions are seamless flush finish door jamb systems. These eliminate the need architraves around the door frame and create seamless clean lines. The modern square set interior doorway system.

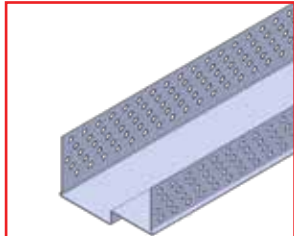

REDISET SINGLE REBATE

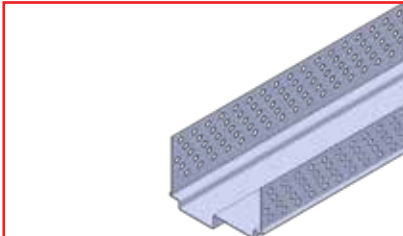

REDISET SINGLE STEPPED REBATE

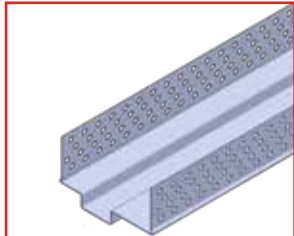

REDISET DOUBLE REBATE

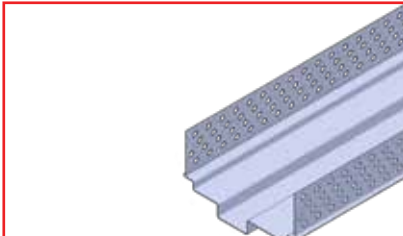

REDISET DOUBLE STEPPED REBATE

METAL CLAD & EDGE CAPPING FOR DOORS

Exterior cladding and capping for both commercial & residential purposes. Available in Zinc, Colorbond, Steel & Aluminium.

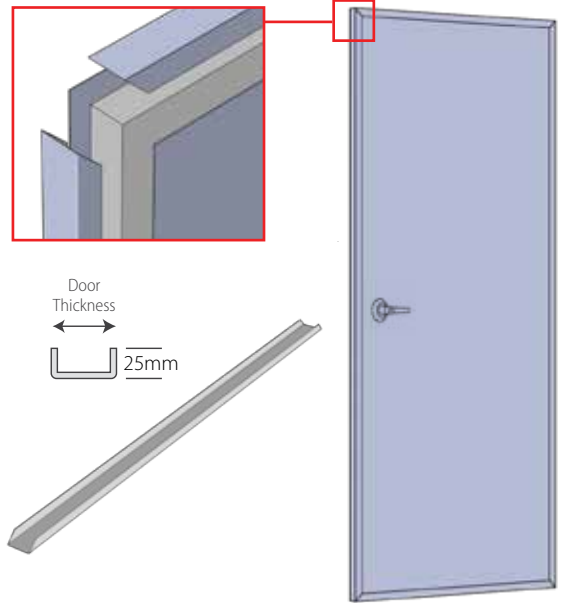

SILL PROTECTORS

Protects the door sill from damage during construction and keeps door sill looking new.

WEATHERGUARD FRAME SILL PROTECTOR

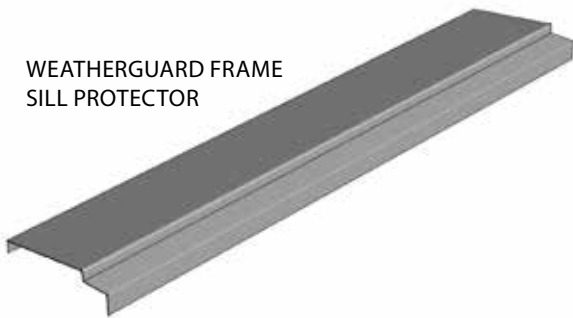

PIVOT FRAME SILL PROTECTOR

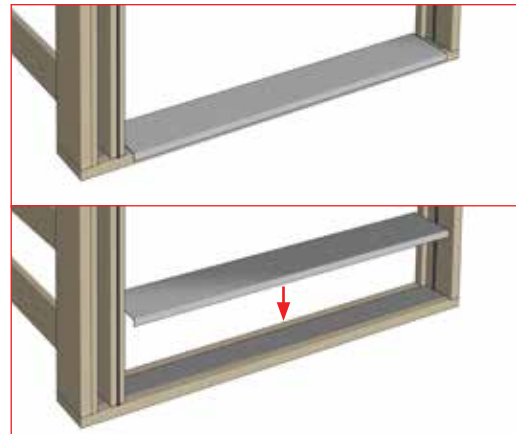
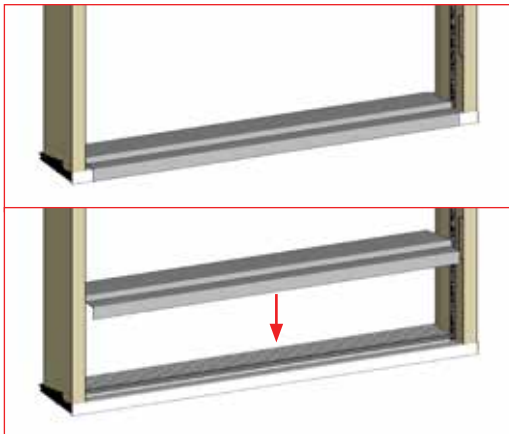
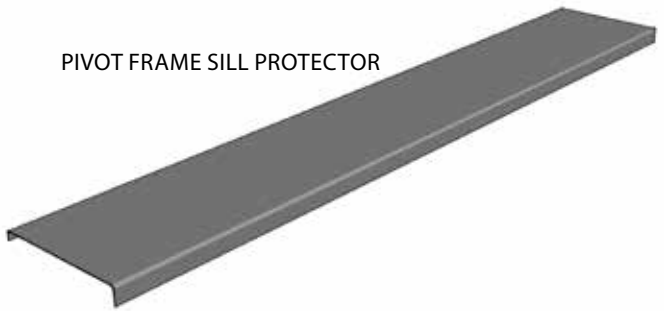

DOOR STIFFENERS

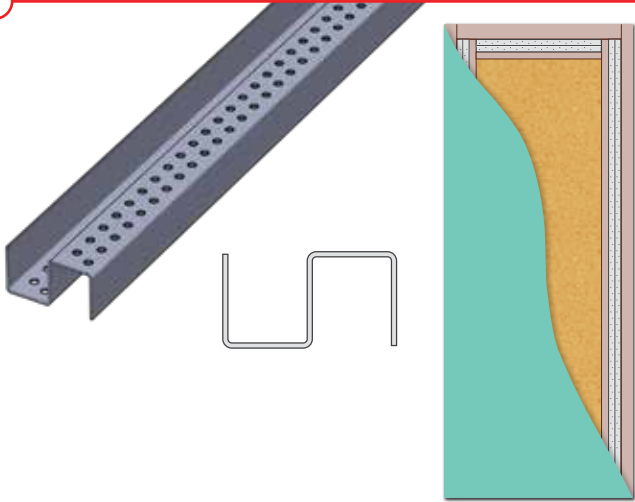

Door stiffeners protect oversized doors from warping. Bowing in oversized doors (both swinging and cavity) is a common long-term challenge that can be prevented by strengthening door construction with a door stiffener.

OVERHEAD WEATHER PROTECTORS

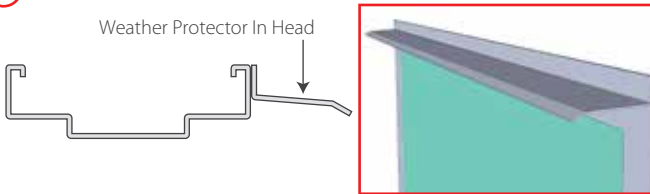

Custom manufactured overhead weather protectors are made with quality materials and are an excellent solution for access doorways in commercial buildings with no overhead protection.

REINFORCED GUARDS

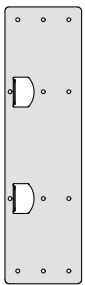

LOCK GUARD

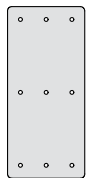

HINGE GUARD

Lock and hinge guards are reinforced plates fitted to the steel door frame to provide strength and security. They are designed to suit any type of lock and hinge.

DOOR PROTECTION PLATES

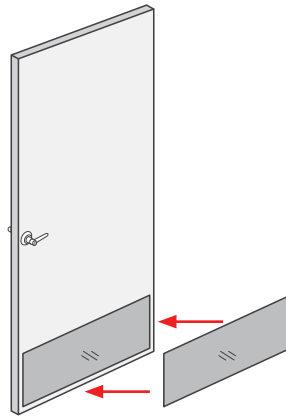
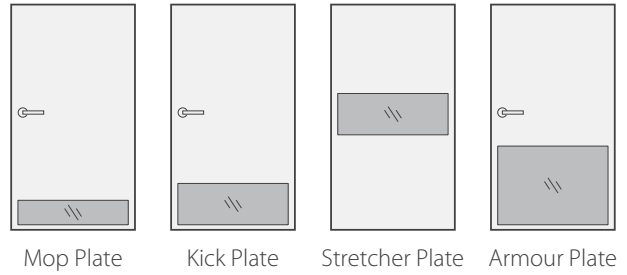

Protection plates are used to protect a door from excessive use. Offering durable protection against constant punishment and wear and tear from equipment and pedestrian traffic. Manufactured from 304 stainless as standard with other grades available on request.

ACCESS HATCHES



A sturdily built access hatchway for safe access/egress to the roof/wall. Ideal for numerous applications in both commercial and domestic situations.



EVOLUTION STEEL STANDARD CAVITY UNIT

The Evolution Steel cavity allows the door to slide inside the wall creating space normally taken up by a swinging door. Strong, durable and with quad wheel carriages that will smoothly move a door mass of 70kg, making this the right choice for commercial space saving.

EVOLUTION STEEL COMPLETE CAVITY UNIT

The Evolution Steel Complete is the perfect flush cavity sliding door system. Designed to incorporate our one touch release and soft closing technology, allowing for the most effortless operation of any sliding door system. The one touch release is magnetised and will hold your door firmly inside the cavity. With one easy touch, the spring loaded system will release the door, sliding with ease across the opening, while the soft closer will gently slow and close the door.

SIZE SPECIFICATIONS

Standard Size (mm)	Stud Thickness (mm)
2040 x 620 / 720 / 770 / 820 / 870 / 920	64 / 70 / 75 / 90

- Special sizes available.
- Evolution Steel Cavity with 64mm stud suits 13mm sheeting material only.

FEATURES OF EVOLUTION STEEL CAVITY UNITS

	EVOLUTION STEEL CAVITY	EVOLUTION STEEL COMPLETE
Engineered to be strong and durable	✓	✓
Smooth 4 wheel ball bearing carriages	✓	✓
Jump free U Track for smooth operation	✓	✓
Maximum door mass 70kg	✓	✓
Quick release to easily remove door	✓	✓
Tough composite split jambs	✓	✓
Termite proof steel back posts, slats & track	✓	✓
Same architrave height as a hinged door		✓
One Touch Release System		✓
Soft Closer Technology		✓

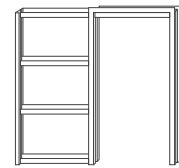

■ Single Cavity Unit

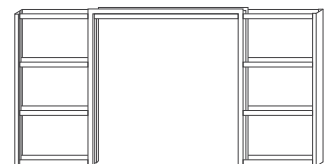

■ Double Cavity Unit



OPTIONAL EXTRAS FOR EVOLUTION STEEL

Soft Closer
Evolution Touch
Closing Jamb
Enclosing Jamb
Double Cavity Unit Connector
Cavity Track Door Stop for Double Cavity Application
Cavity Guide
Staingrade Upgrade
Timber Pelmet to suit Double Cavity Unit

- Cavity Units are recommended for 35mm doors only.
- Door Stiffeners are perfect to prevent warping of cavity doors. Refer to page 13.

ADD ON OPTIONS FOR EVOLUTION STEEL

SOFT CLOSER

(Available separately)

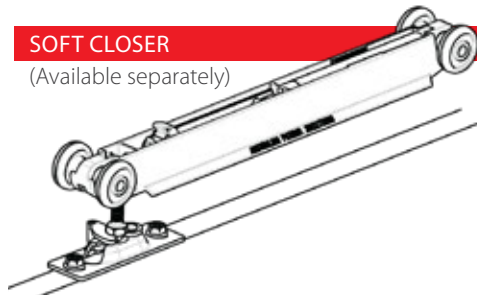

Scan QR for Soft Closer Installation Video

CAVITY TRACK DOOR STOP

(For double cavity application)

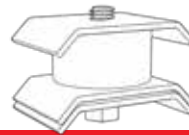

ONE TOUCH RELEASE

(Available separately)

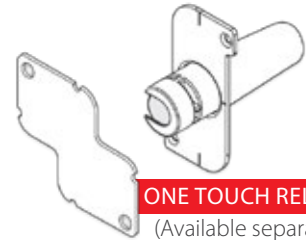

DOUBLE ADAPTOR

(For double cavity application)

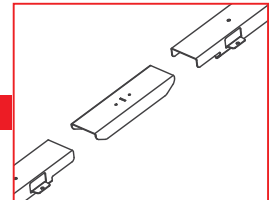
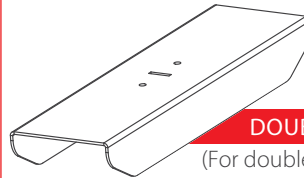

SQUARE SET REVEALS FOR STEEL CAVITY UNITS (LENGTHS: 1800/2400/3000mm)

Cavity Square Set Reveals provide a modern, clean wall finish by replacing timber architraves and timber closing jambs. This design solution integrates the wall and the door opening, providing a seamless and clean flow from the cavity to the wall.

CLOSING JAMBS REVEAL

92, 40, 0.75

112, 40, 0.75

118, 40, 0.75

Closing Recessed Jamb Profile

46, 10

■ Door closes on the closing jamb

SPLIT JAMBS REVEAL

34, 40, 0.75, 17

31, 40, 0.75, 17

■ Used on the cavity pocket split jamb

LONG LEGGED STOPPING BEAD

0.75, 40, 17

■ Used in place of top of cavity pelmets

■ Universally used on wall corners



ALUMINIUM DOORS ELITE DOOR RANGE

✓ 5 Year Guarantee



- ✓ Highly durable and effective in exposed weather situations
- ✓ Works with timber or aluminium jambs
- ✓ For ultimate weather protection match with the Weatherguard Timber Frame
- ✓ Choose from six beautiful powder coated finishes ready to install
- ✓ Architecturally designed and developed with five design options
- ✓ Low maintenance

The Elite Aluminium Range is sleek, durable and effective in any weather exposed situations. As the result of innovation and industry development, these architecturally designed doors work perfectly with timber or aluminium jambs and are beautifully powder coated for low maintenance.

Standard Sizes

- 2040x820/920/1200x40 , 2340x1200x40
- Made to order available

ALUMINIUM ELITE DOOR COLOUR/FINISH CHOICES & FITTINGS

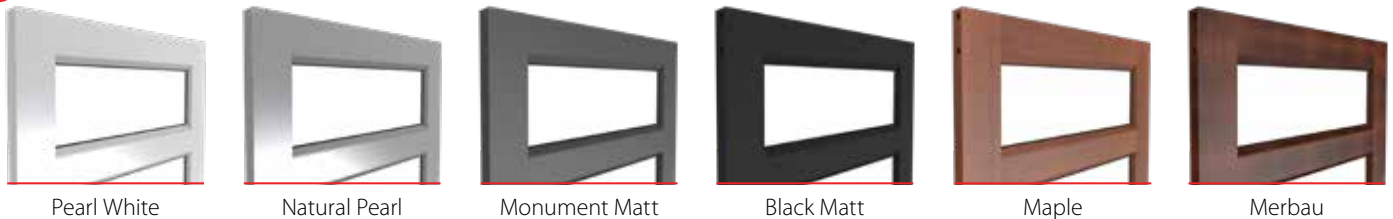

Pearl White

Natural Pearl

Monument Matt

Black Matt

Maple

Merbau

ALUMINIUM ELITE DOOR RANGE

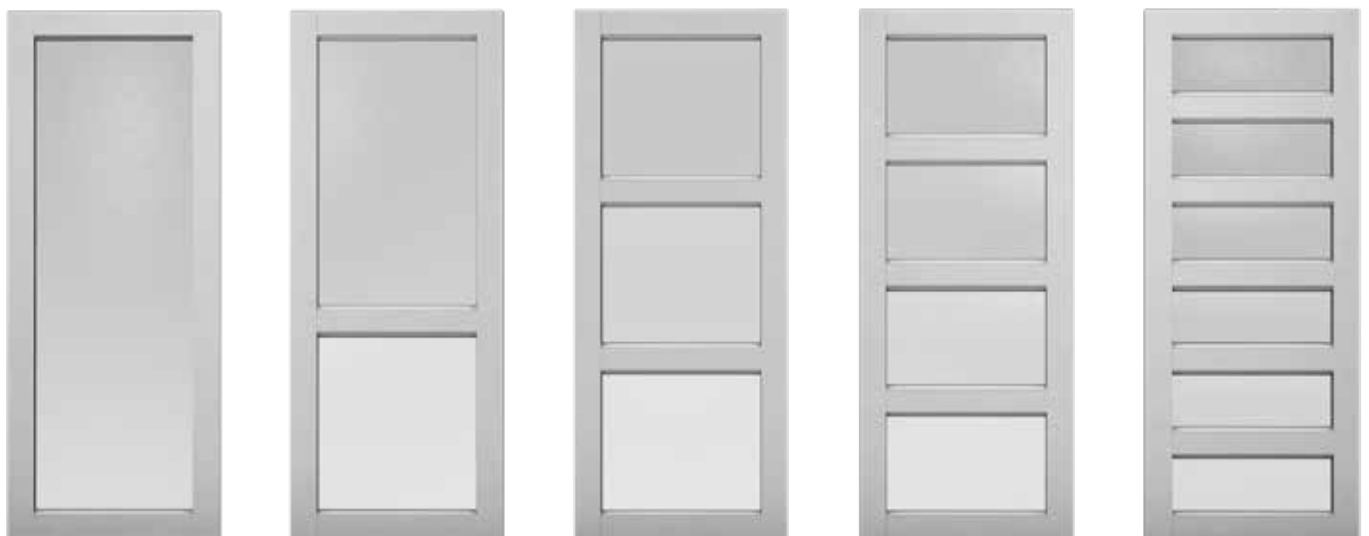

XE1

XE2

XE3

XE4

XE6

- All doors excluding XE2 can be rotated to change the handing. XE2 requires choosing handing when ordering.
- Doors are available with or without door furniture.

Styles	100mm
Rails	90mm
Mid Rails	85mm plus Aluminium Glazing Beads
Hinges	100mm



XE3 in Weatherguard Timber Frame

WEATHERGUARD SOLUTION

- ✓ Compatible with Weatherguard Timber Frames for ultimate weather protection
- ✓ Full perimeter seals for maximum energy efficiency

HANDLE OPTIONS

✓ 1 Year Guarantee

C4 EURO HANDLE WITH MORTICE LOCK



Satin Chrome

White

Black

TRI LOCK OPTION ALSO AVAILABLE



Satin Chrome

Bright Chrome

Matt Black

GLASS OPTIONS



Clear Laminate



Translucent Laminate

HINGE OPTIONS

✓ 1 Year Guarantee



White

Satin Chrome

Black

STEEL DOOR FRAME WARRANTY

Subject to terms and conditions set forth herein, steel door frames manufactured and/or supplied by: Hume Doors & Timber (Aust) Pty. Ltd., Hume Doors & Timber (Qld) Pty. Ltd., Hume Doors & Timber (Vic) Pty. Ltd., Hume Doors & Timber (SA) Pty. Ltd. or Hume Doors & Timber (WA) Pty. Ltd. (hereinafter referred to as "the Company") are warranted by the manufacturer and/or supplier for one year from the date of shipment by the manufacturer and/or supplier to be of good material and workmanship, free from defects which render them unserviceable or unfit for the use for which they were manufactured.

THE COMPANY WARRANTS:

1. Goods manufactured and/or supplied for a period of one (1) year as from the date of shipment, to be free from defects in material and workmanship which would render them unserviceable or unfit for normal use.
2. To the extent permitted by law or the express provision of any statute or otherwise hereby expressly excluded and in respect warranties that cannot be so excluded, these terms and conditions shall be read such that those statutory warranties are read as being in addition to the warranties hereby given.
3. Subject to Clause 2, the warranty in Clause 1 shall be read subject to the following matters being excluded as defects:
 - 3.1 Frames not accorded reasonable treatment by the customer.
 - 3.2 Damage or defects arising out of, or in connection with, shipment or storage after frames leave the control of the company (i.e. delivered to site or handed over to a carrier). Frames must be inspected by the customer for visible defects immediately upon delivery.
 - 3.3 Claims for non conforming deliveries (incomplete defective or incorrectly supplied) will only be considered if made within 3 working days of receipt or delivery of frames. All delivery checks are the responsibility of the customer.
 - 3.4 Under NO circumstance will the company be liable if frames are installed before checking that they are supplied correctly and are free from defects.
 - 3.5 Factory priming is only to protect frames in transport and general handling it is the responsibility of the customer to immediately on delivery of all frames apply 2 coats of compatible sealing priming to ensure corrosion or the like does not occur.
 - 3.6 It is the responsibility of the installer to ensure that the frames are installed plumb, square and suitably anchored using the correct fixing points.
 - 3.7 Storage and security of the frames is not the responsibility of the company.
 - 3.8 Stainless steel hinges are required to be maintained every 2 months to ensure prevention of tarnishing and corrosion.

GUARANTEE DOORS

Our products come with guarantees that cannot be excluded under the Australian Consumer Law. You are entitled to a replacement or refund for a major failure and for compensation for any other reasonably foreseeable loss or damage. You are also entitled to have the goods repaired or replaced if the goods fail to be of acceptable quality and the failure does not amount to a major failure.

Subject to terms and conditions set forth herein, doors manufactured by: Hume Doors & Timber (Aust) Pty. Ltd., Hume Doors & Timber (Qld) Pty. Ltd., Hume Doors & Timber (Vic) Pty. Ltd., Hume Doors & Timber (SA) Pty. Ltd. or Hume Doors & Timber (WA) Pty. Ltd. (hereinafter referred to as "the Company") are guaranteed by the manufacturer for five years (Fire doors excluded and carry a one year guarantee) from the date of shipment by the manufacturer to be of good material and workmanship, free from defects which render them unserviceable or unfit for the use for which they were manufactured.

TERMS AND CONDITIONS

Natural variations in the colour, texture or grain pattern of the wood or MDF are not to be considered defects. Doors must be accorded reasonable treatment by the purchaser and should be stored or hung in dry buildings and not in damp, moist or freshly plastered areas. The utility or structural strength must not be impaired in the fitting of the door, the application of hardware, or cutting and altering of the door for lights, louvres, panels or any special details. A maximum of 3mm may be trimmed from any edge of the door. This must be done evenly. Normal "show-through" of frame components in doors shall not be considered a defect. Entrance/solid doors up to 2040 x 820 require three hinges, larger doors require four hinges or pivot system. **ENTRANCE DOORS & ENTRANCE SYSTEMS SHOULD BE HUNG IN WEATHER PROTECTED AREAS.**

Doors and door systems including pivot systems that are installed in a fully exposed situation including opening out doors will not be warranted. Immediately after fitting and prior to hanging, the entire door including the top and bottom edges must be painted. Use a good quality paint or coating system and always follow the paint

manufacturer's advice. Pay particular attention to internal vs external paint systems and use the one appropriate to where you are hanging the door. This includes doors that are supplied raw or factory primed. If staining, must use exterior grade varnish/sealer to prevent absorption of moisture. Always follow the varnish/sealer manufacturer's advice. SEMI GLOSS OR SATIN FINISHES ARE RECOMMENDED FOR ALL DOORS TO REDUCE "SHOW-THROUGH".

Exterior finishes to be applied strictly in accordance with paint manufacturers instructions. Entrance and exterior doors should be finished in light reflective colours to reduce the risk of heat absorption which causes warping. DARK COLOURS WILL VOID WARRANTY. Regular maintenance should be provided to prevent deterioration. Where any legislation provides for remedies for the Company's breach of a condition or warranty whether statutory or otherwise, then, at the Company's option, the customer's sole remedy for such breach except a breach of Section 69 of the Trade Practices Act will be limited to: such remedy, or the repair of the products, or the replacement of the products or the re-supply of the products; or the payment of the cost of replacing the products; or the cost of having the services supplied again; or the re-provision of the services. No claim will be accepted unless notified in writing to the Company within seven (7) days of the date of delivery of the products or the supply of the services.

The Company will not be held responsible for additional charges of hanging, painting or other charges arising from the replacement of doors. Any such defects must be brought to the attention of the manufacturer when discovered and in any event within five years from the date of shipment by the Company. The Company is not liable to reimburse any purchaser for doors repaired or replaced without the prior written consent of the Company to such repair or replacement. The Company will not assume responsibility for doors which become defective because of failure to follow these conditions or hazards of shipment or storage, after doors leave the control of the Company. The Company will not be liable for any costs, claims, damages or demands arising from the personal injury, loss or damage whatsoever occurring to the customer or its agents, servants as a result of either acts or omissions of the customer. The Company will not be liable for

any consequential loss or damage, whether due to its negligence or otherwise. The Company will not be liable to the customer for the Company's failure to comply with its obligations to the customer due to any cause beyond the Company's reasonable control and the Company's obligations affected by such cause are suspended while the cause continues to prevent or hinder the Company's performance.

ADVISORY NOTE

Considerable damage can occur during the delivery of doors particularly to country areas. "Special Packaging" is recommended (optional extra cost) in an attempt to prevent transit damage. The Company is not responsible for any transit damage.

INTERPRETATION OF WARP

Warp shall be interpreted as meaning the cupping/bowing or twisting of doors. It refers to distortion within the door itself and not its relationship to the jambs or frame in which it is hung. Warp of 4mm or less for doors up to 2150mm high and 6mm or less for door heights between 2150mm and 2400mm shall not be considered a defect. Doors over 2400mm high or 1020mm wide are not guaranteed against warp.

EXCLUSIONS

The guarantee against warp does not apply to the following:

- a. Doors with face veneers of different species.
- b. Doors that are improperly hung or do not swing freely.
- c. External flush doors which have been painted or stained dark colours, or different colours each face.

Experience has demonstrated that when warp occurs after doors have been delivered to storage or building sites, it is usually due to improper storage or adverse moisture conditions after hanging and not to faulty manufacture. The Company will accept no responsibility for doors when moisture content of the timber falls below 12% or exceeds 18%. The Company will not accept responsibility for conditions wholly beyond its control. However, the Company should be consulted promptly if excessive warping occurs to provide assistance in overcoming the difficulty.



DEDICATED TEAM | SPECIALIST SERVICE | NATIONAL SUPPORT

- ✓ Specialist Sales Representation
- ✓ Hume Commercial onsite solutions
- ✓ National, State & Local network, including a dedicated estimating service
- ✓ Consultation services for builders - Providing dual calls with members from your team
- ✓ Exploring alternative designs? Our expert team can help with design recommendations and CAD expertise
- ✓ Daily delivery service





Hume Commercial Doors & Frames is an Australian commercial building products manufacture that is a division of the Hume Group of companies.

NEW SOUTH WALES

BERESFIELD

ABN 39 001 472 493

📍 57 Elwell Close , Beresfield NSW 2322

☎ P: 02 49 668880

F: 02 49 668881

✉ E: nswinfo@humecommercialdoors.com.au

QUEENSLAND

BUNDAMBA

ABN 93 010 920 117

36 Masterpanel Lane

📍 Bundamba QLD 4304

☎ P: 07 3282 2888

✉ E: sales@humemasterpanel.com.au

VICTORIA

CAMPBELLFIELD

ABN 87 006 329 906

📍 70 Merola Way, Campbellfield VIC 3061

☎ P: 03 8906 2300

F: 03 9799 9688

✉ E: info@humecommercialdoors.com.au

Disclaimer: Hume Commercial Doors & Frames reserves the right to alter or amend without prior notice, any data, dimensions and design details specified herein. Photographs or illustrations may not depict the exact design or specification and may vary to the actual product. Products are supplied unfinished unless otherwise specified and routed doors have exposed MDF.