

KEKSIÄ

+ Raised Floor Systems

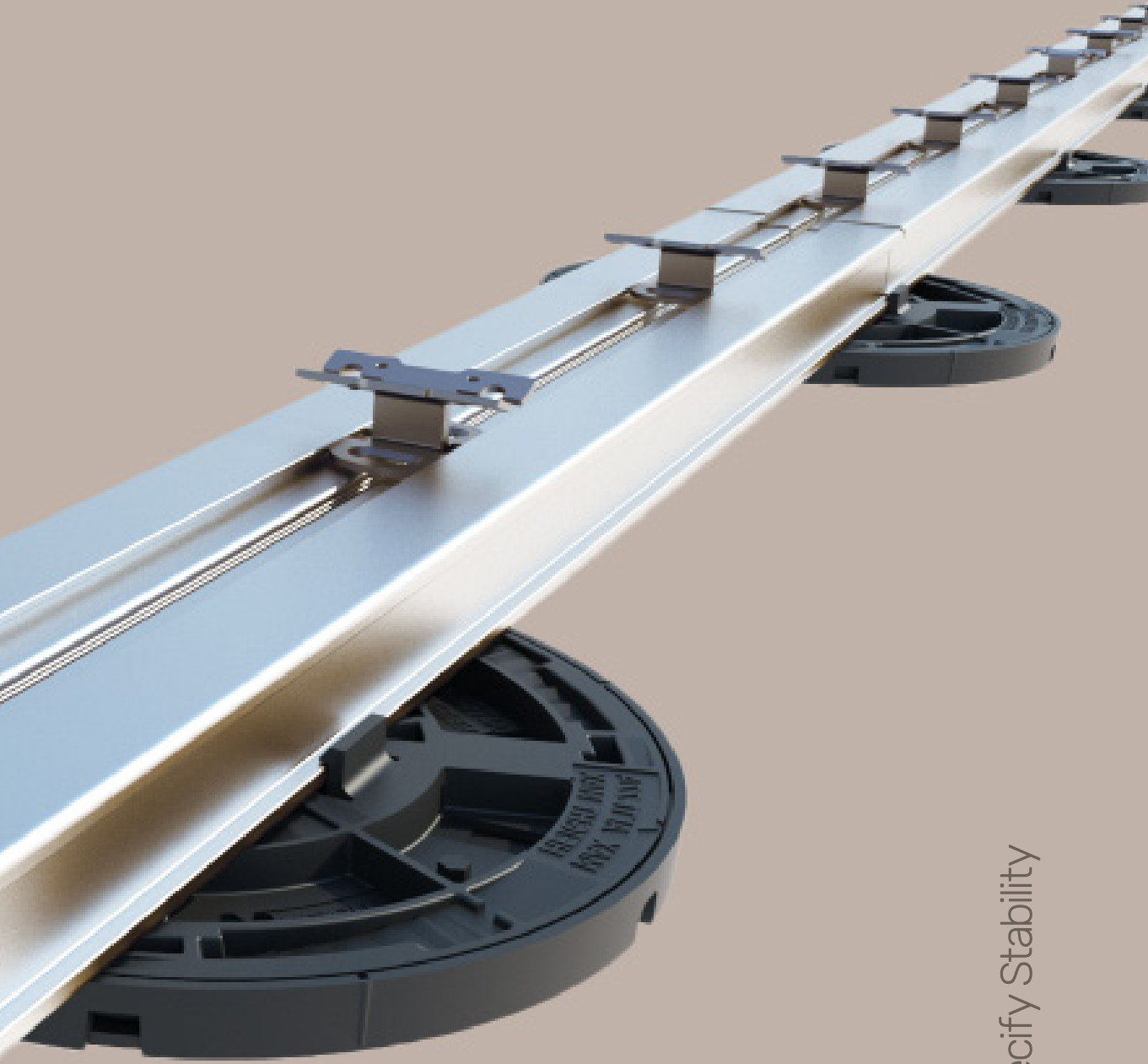

WOODECK

+ Specify Stability

PEDESTAL ADVANTAGES

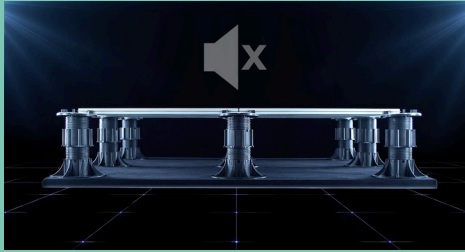

Acoustic Insulation



Quick Water Drainage

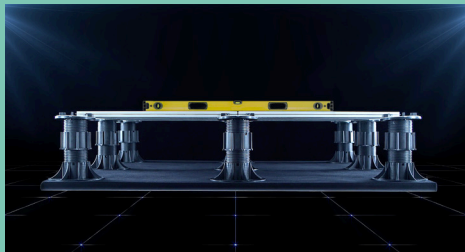

Perfectly Level Surface

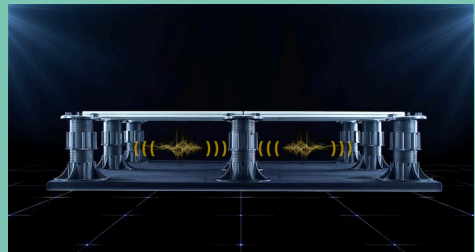

Absorption of Structural Movement

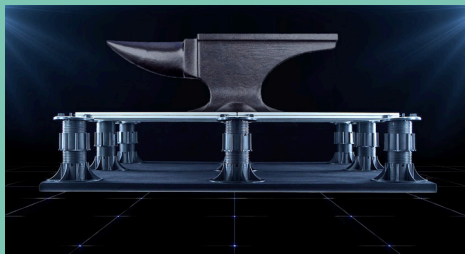

High Strength and Resistance



Entirely Recyclable

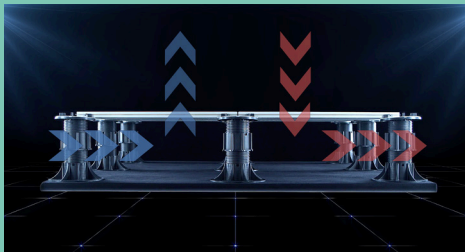

Better Thermal Insulation

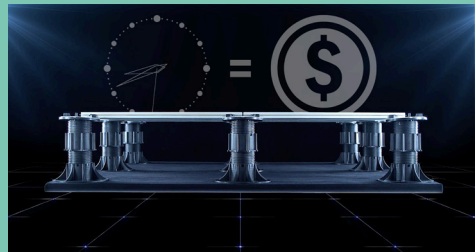

Time Effective Installation



Easy Access and Concealment

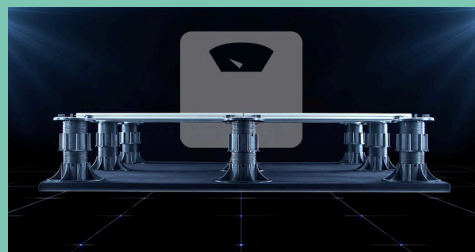

Low Weight

HEAD TYPES

Pedestal Head for Aluminium Joist System

The Aluminium Joist System is assembled without the use of screws and is composed of three exclusive features:

- Pedestal head with two pre-formed clips securing the Aluminium Joist
- Aluminium Joist
- Sliding and rotating clips for fastening

The clips can be customised upon request to suit the chosen floor type.

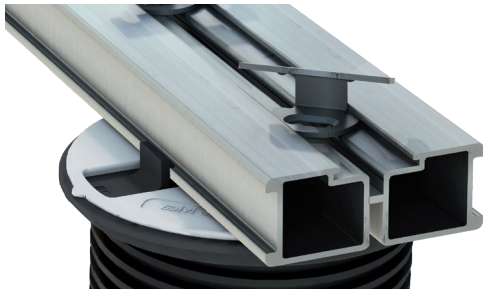

Pedestal Head for Aluminium Joist System

The Wood Deck System is designed to accommodate and permit the fastening of all types of existing joists on the market.

The slots in the head enable mechanical coupling with joists 18mm thickness and above, thanks to the removable pre cut tab.



NM

ADJUSTABLE HEIGHT SUBSTRUCTURE WITH NM SERIES PEDESTAL

The NM Adjustable Height Pedestal accommodates all joist types utilising the interchangeable head, which adapts to both the Aluminium Joist System, as well as the Wood Deck System.

A simple rotation of the base allows you to adjust to the millimetre every type of substructure and obtain stable, perfectly level flooring.

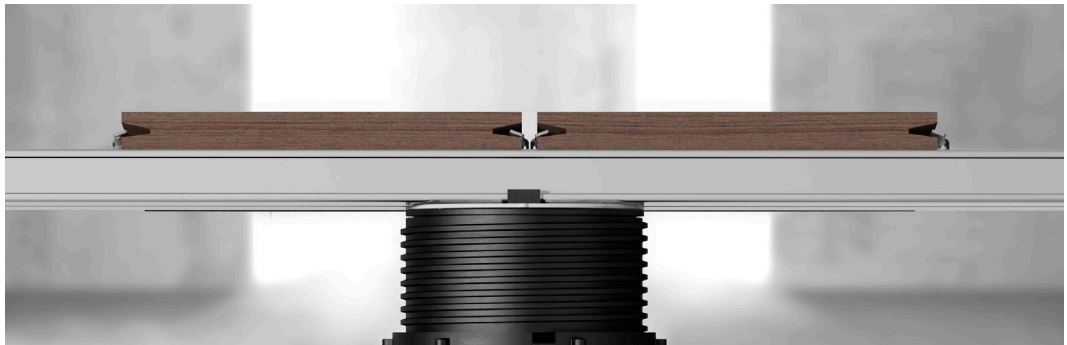

Aluminium Joist System

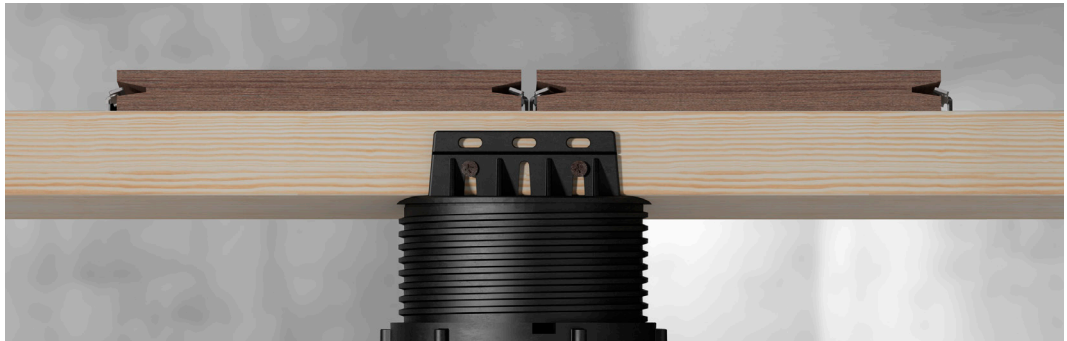

Wood Deck System



TW 110
Ø 110 mm



LGH1-LGH2-LGH3
1-2-3 mm



XL head
Ø 150 mm



NM 1
25-40 mm



NM 2
40-70 mm



NM 3
60-100 mm



NM 4
90-160 mm



NM 5
150-270 mm



PNM
Extend up to 990mm

SE

SELF-LEVELLING AND ADJUSTABLE SUBSTRUCTURE WITH SE SERIES PEDESTAL

The SE Self-Levelling and Adjustable Pedestal accommodates all joist types. The product's main strength is its interchangeable head, which adapts to both the Aluminium Joist System, as well as the Wood Deck System.

The unparalleled performance of the tilting head is capable of eliminating screed slopes of up to 5%, resulting in a perfectly level floor, with no need for additional work or extra spacers.

It's the most flexible, elegant and safe solution that's ever been conceived for terraces, decking and poolside applications.



Aluminium Joist System



Wood Deck System

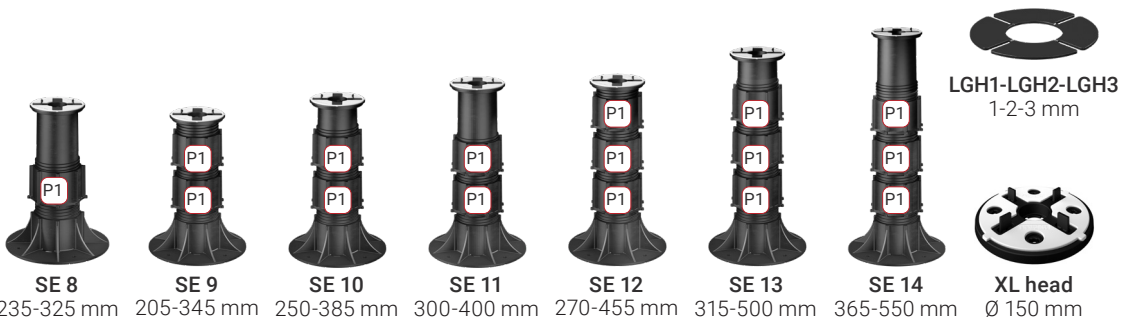

ST

LOW HEIGHT AND ADJUSTABLE *SUBSTRUCTURE WITH STAR.T SERIES PEDESTAL*

The Star.T Low Height Adjustable Pedestal is a compact support that has the ability to be used on any kind of floor. Adjustable from 10 to 30 mm pre formed clips accommodate the Aluminium Joist System or can be interchanged with the Wood Deck System.

Millimetre perfect adjustment of the ST Series allows it to obtain elegant, perfectly level floors, reducing installation costs with guarantee of stability and precision.



Aluminium Joist System



Wood Deck System



To suit Aluminium Joist System

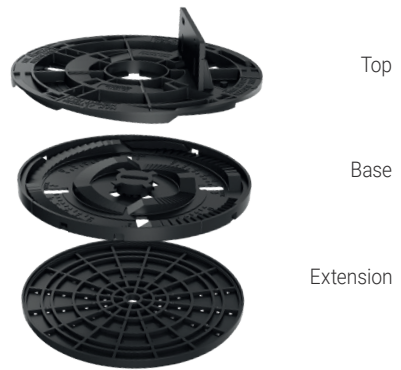

To suit Wood Deck System

FAST, SAFE AND TROUBLE-FREE INSTALLATION

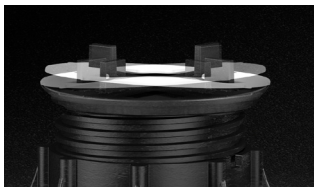

The self-levelling head automatically compensates any slope up to 5%.



Pre-cut tab is easily removable. Coupling head to screw attachment system.



Bi-material, PP + rubber anti-noise and anti-slip head.

CLIP WFS® HEAD FOR VERTICAL INFILL

- 1 WPC, wood, ceramic, plastic, concrete or other composite material flooring
- 2 Aluminium Joist
- 3 Clip WFS® head for vertical infill
- 4 Adjustable Pedestal
- 5 Base clip for vertical infill
- 6 Clip for Aluminium Joist





K

KEKSIÄ

T 1300 633 099

E sales@keksia.com.au

keksia.com.au

MADE IN ITALY