

860 x 500 SINGLE BOWL WITH DRAINER INOX STAINLESS STEEL

PRODUCT CODE: **MS100S**





MILAN SINKS

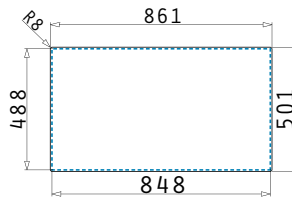
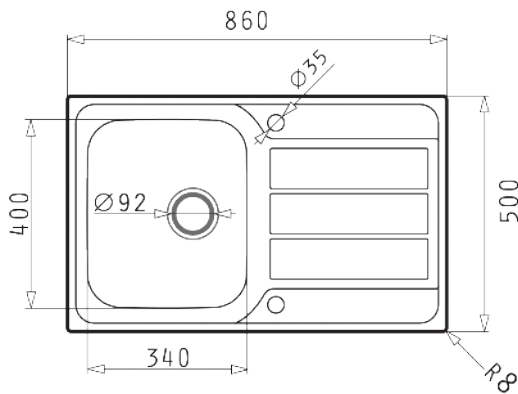

DIMENSIONS

CUT-OUT



 Safety	 Material	 Heat Resistance	 Shock Resistance	 Certifications
---	---	--	---	---

Material	Polished Stainless Steel
Installation	Flushmount - align at the same level
Fixings	8 fixing clips
Sink Dimensions	860 x 500mm
Bowl Dimensions	340 x 400 x 180mm
Cabinet Cut-Out	Flushmount
Min Cabinet Size	450mm
Bowl Capacity	24 L
Overflow	Integrated bowl overflow
Tap Holes	Tap hole drilled

25

YEARS*

*Conditions apply

INSTALLATION TYPE

FLUSHMOUNT



WASTE FITTING

Supplied with designer waste and plug



OPTIONAL ACCESSORIES



Walnut Chopping Board
MACC093



Stainless Steel Colander
MACC094



Stainless Steel Roll Mat
MACC098



Waste Cover
MACC106

RECOMMENDED TAPWARE



CODE: EMT1088



CODE: EMT102