



ROOF & WALL FLASHING

ARCHITECTURAL DETAILING

D E S I G N G U I D E



ROOF & WALL FLASHING

ARCHITECTURAL DETAILING

This Design Guide has been prepared to assist architects and architectural draftspersons with the design and installation intricacies of detailing roof and wall flashing for metal cladding. Quality of a finished installation is dependent on good detailing.



Important note

The information contained within this brochure is as far as possible accurate at the date of publication, however, before application in a particular situation, Stramit Building Products recommends that you obtain qualified expert advice confirming the suitability of product(s) and information in question for the application proposed. While Stramit Building Products accepts its legal obligations, be aware however that to the extent permitted by law, Stramit Building Products disclaims all liability (including liability for negligence) for all loss and damage resulting from the use of the information provided in this brochure.

Contents

Roof Flashing

| | |
|-----------------------------|----|
| Large Roof Penetration | 8 |
| Small Roof Penetration | 8 |
| Change of Pitch | 8 |
| Mansard | 9 |
| Expansion Joint | 10 |
| Ridge Capping | 10 |
| Raked Roof | 11 |
| Box Gutter | 11 |
| Barge Gutter | 12 |
| Barge Capping | 12 |
| Curved Barge | 12 |
| Parapet – Top | 13 |
| Parapet-to-sheet Connection | 13 |

Wall Flashing

| | |
|----------------------------|----|
| Mid-Wall Connections | 14 |
| Internal Corner – Trim | 15 |
| Internal Corner – Moulding | 15 |
| External Corner – Trim | 16 |
| External Corner – Moulding | 17 |
| Wall to Eaves/Soffit | 18 |
| Fascia Purlin | 18 |
| Bottom of Wall | 19 |
| Window/Door | 20 |
| Wall Penetrations | 22 |

Introduction

This guide presents alternative methods of finishing metal-clad roofs and walls. In some instances flashing is best when almost invisible, and there are other cases where making a feature of flashing can enhance appearance. Renditions of some key aesthetic differences between alternatives have been included to show choices. In addition, commentary is made on aspects such as potential distortion around fixings. Important functional considerations have also been addressed where applicable.

As the details shown are applicable to a wide range of **Stramit® Roofing and Walling** profiles, only sample dimensions are given on each page. A section of the guide is dedicated to typical dimensions for a range of profiles, along with a number of advisory minimum and maximum values for specific applications.

The solutions given are typical only. Many real applications will require the adaptation of the ideas shown here, or the development of unique solutions using the principles set out in this guide.

Materials

Stramit® Roof and Wall Flashing is generally manufactured from G300 steel with protective coatings of ZINCALUME®, galvanised or COLORBOND®. Other materials, such as COLORBOND® Ultra, COLORBOND® Stainless, Uncoated Stainless, Copper and Aluminium are also available.

Colours

Stramit® Roof and Wall Flashing is available in a comprehensive range of colours, identical to those used for the sheeting. Contact your nearest Stramit office for colour charts or samples.

Durability

Selection of the correct materials in order to achieve the desired durability is important. This includes consideration of contact and water drainage between different materials. Extensive details of these durability considerations can be found in the **Stramit® Premium Materials and Finishes Design Guide**.

Tolerances

Stramit® Flashing, whether standard or special, is manufactured to the same high standards and tolerances. Although normally produced within these values, assume the following tolerances when detailing flashing:

- fold to fold and fold to edge distances +/- 2mm
- overall length +/- 15mm
- bend angles +/- 2°
- out of straightness 2mm per m of length

Should tighter tolerances be required for a specific application please contact your nearest Stramit office.

Installation Skills

Flashing must be installed by a skilled tradesperson if quality results are to be achieved. This is particularly so for details such as door and window corners, and for flashing that has exposed fastenings. Careful design of flashing details to suit the application can help to ensure reliable function and a quality finish.

Cutting

Stramit® Flashing may be cut and trimmed easily on site using tin snips. All materials offered are either intrinsically durable or have sacrificial coatings that protect such cut edges in the same way as for the slit edges on the flashing.

Insulation

Flashing details should take into account any insulation (foil, blanket etc.) to be incorporated into the building element. For roofs, blanket greater than 50mm can cause complications with roof sheet fastening.

Stramit Speed Deck Ultra® concealed fixed decking can readily be installed with 75mm blanket and up to 100mm with care. Even greater thicknesses, and superior thermal isolation, can be achieved by the placement of Styrofoam blocks beneath the fixing clips.

Roof Overhangs

Although not a detail requiring the use of flashing, attention is drawn to the detailing of roof sheet overhangs. Stramit technical manuals give maximum overhangs for each roofing profile. For example corrugated sheeting has a 100mm maximum overhang when unstiffened and 200 to 300mm (depending on wind load category and steel grade) when stiffened by the attachment of a continuous supporting member such as an S-type gutter, a roof batten or a lipped angle.

Numerous instances have been observed of sheeting (often spring curved) being extended well beyond these limits. This is a safety hazard for persons walking on the roof (either during installation or at a later date) and must be avoided.

Ordering

Orders for **Stramit® Flashing** may be sent as a simple drawing showing each flat length in whole millimetres and the least angle between each flat in whole degrees. **Stramit® Regional Price and Service Guides** contain illustrations of many common custom flashing arrangements. These can be adopted by referencing the custom flashing design number and writing the values for each letter and angle. Note that there are regional variations in these common custom flashing designs and their designations. Please contact your nearest Stramit office to obtain a copy of the *Price and Service Guide*.

Lead-time

Most **Stramit® Flashing** is made to order regardless of whether it is a standard design or custom designed. The manufacture and delivery times are aligned with those of roof and wall sheeting manufacture. Check with your nearest Stramit branch office for delivery times.

Girth Widths

Stramit® Flashing is made from (and hence costs are based on) a range of girth widths. These are generally from 100 to 500mm in increments of 50, thence 600, 800, 900, 1000 & 1200. It is suggested that, where practical, the girth width used for any flashing design is selected from this range, but this is by no means obligatory.

Scribing/Notching

Flashing covering the upper edge (eg ridge capping), or some side edges, of most roofing profiles is scribed or notched to ensure a close fit around the profile ribs. In some regions it has become common practice, with **Stramit® Corrugated** roof sheeting, to shorten the turn down leg to a nominal 10-15mm feather edge and leave this fully above the rib. This could have the effect of rubbing on the rib top, causing potential reduction in durability and sometimes roof noise. This approach also requires alternative means of reducing wind and wind-driven rain intrusion, and vermin-proofing (note that with either approach trough turn-ups are still needed). There may be applications where such a detail is appropriate. It is for the designer to specify whether full scribing is a requirement with flashing for profiled sheeting.

Roof and Wall Profiles

Stramit offers a wide range of roof and wall profiles. There are variations in this range between regions. The table below provides a guide to dimensions and availability of products in each State.

| STRAMIT ROOF AND WALLING PROFILES – Availability and Nominal Dimensions (mm) | | | | | | | | | | | | |
|--|--|-----|----|---|----|----|----|----|------------------|-------------|----------------|---------------|
| roof/wall sheeting | regional availability | | | | | | | | concealed fixing | rib spacing | profile height | profile cover |
| | V | NSW | WA | T | SQ | NQ | NT | SA | | | | |
| Stramit Speed Deck Ultra® | ■ | ■ | ■ | ■ | ■ | ■ | ■ | ■ | ■ | 233 | 43 | 700 |
| Stramit® Corrugated | ■ | ■ | ■ | ■ | ■ | ■ | ■ | ■ | | 76 | 16 | 762 |
| Stramit Monoclad® | ■ | ■ | ■ | ■ | ■ | ■ | ■ | ■ | | 190 | 27 | 762 |
| Stramit Megaclad® | | ■ | | | | | | | | 267 | 27 | 800 |
| Stramit Longspan® | ■ | ■ | ■ | ■ | ■ | ■ | ■ | ■ | | 100 | 27 | 700 |
| Stramit Speed Deck® 500 | | | | ■ | | | | | ■ | 250 | 41 | 500 |
| Stramit Capacity Plus® | | | | | ■ | ■ | ■ | | | 270 | 50 | 810 |
| Stramit Xtraspan™ 900 | available in any region by arrangement | | | | | | | | | 127 | 38 | 41 |
| Stramit K-Panel® | ■ | ■ | ■ | ■ | ■ | ■ | | ■ | | 216 | 12 | 864 |
| Stramit Monopanel® | ■ | ■ | | ■ | | | | ■ | ■ | | 13 | 250 |
| Stramit® Premier 300™ | | | | | ■ | ■ | ■ | | ■ | 150 | 15 | 300 |
| Stramit® C-Clad 280 | | | | | ■ | ■ | | | ■ | | 15 | 280 |
| Stramit Minirib® | ■ | ■ | ■ | | ■ | ■ | ■ | ■ | | | 4 | 900 |
| Stramit Mini Corry® | ■ | ■ | ■ | ■ | ■ | ■ | ■ | ■ | | | 6 | 825 |
| Stramit Lo-Clad™ | | | ■ | | ■ | ■ | ■ | | | 164 | 12 | 820 |

V – Victoria, NSW – New South Wales, WA – Western Australia, T – Tasmania, SQ – South Queensland, NQ – North Queensland, NT – Northern Territory, SA – South Australia

Dimensions

While each flashing design may be different, to suit different roof or wall sheeting and particular applications, there are elements common to each. Many of these detailed flashing design aspects are described below.

Edges

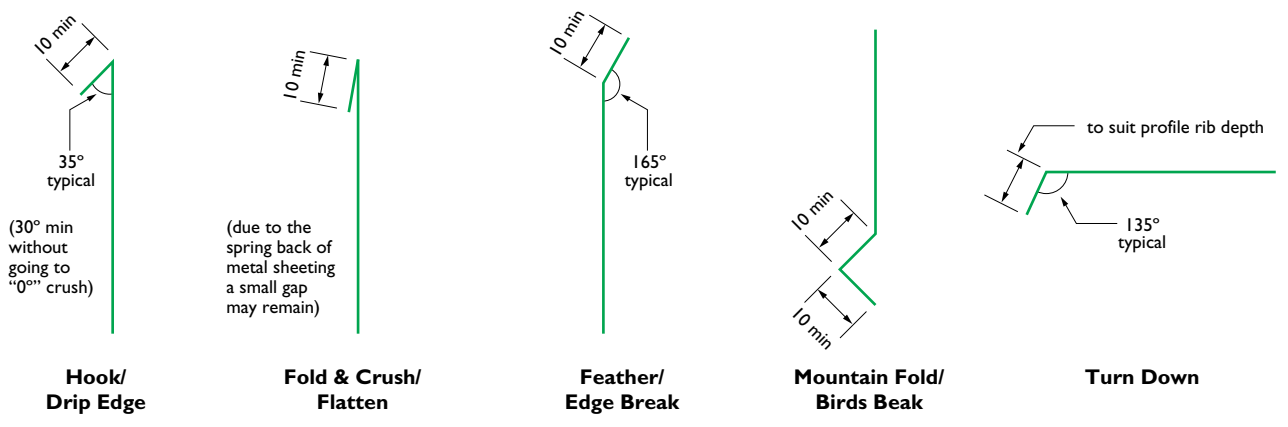

Laps

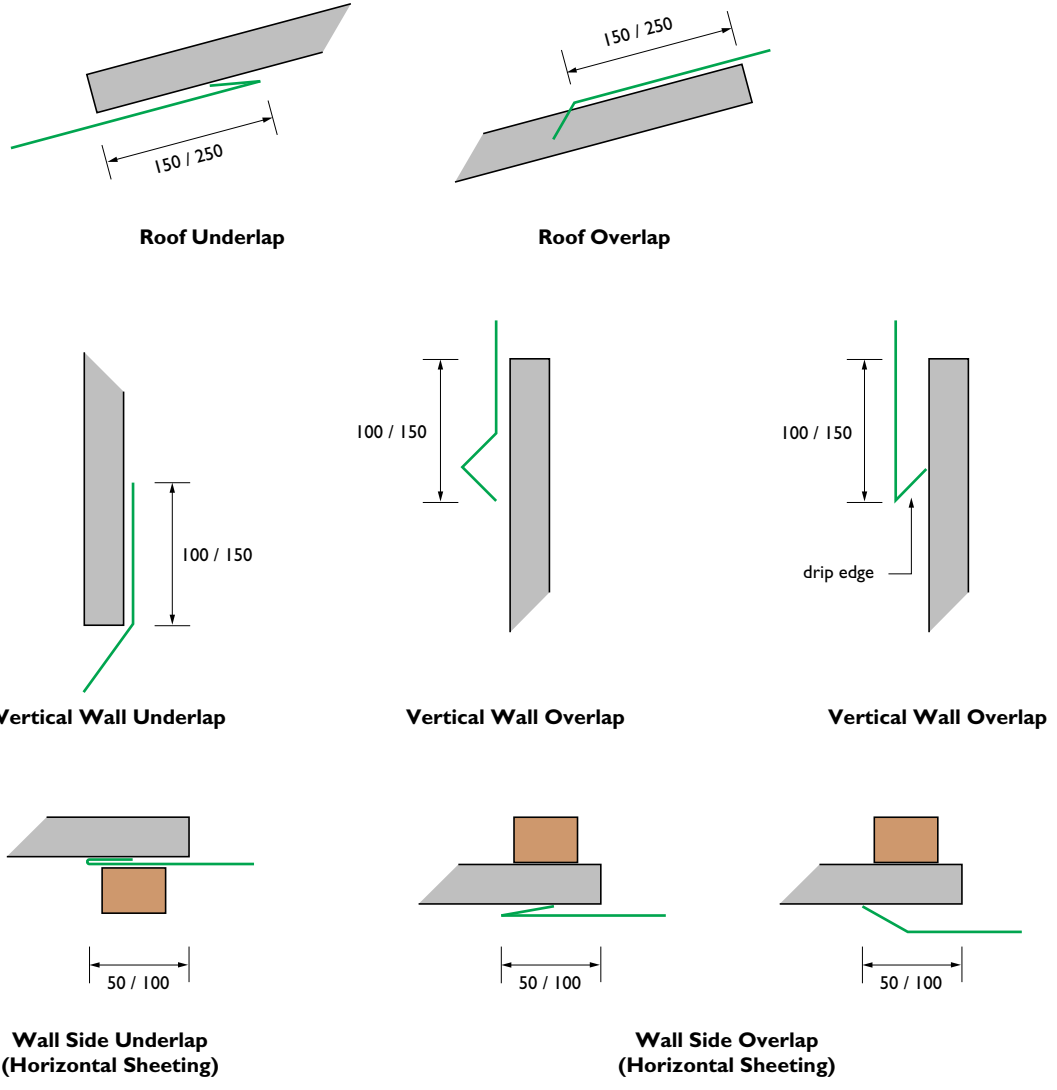

Laps

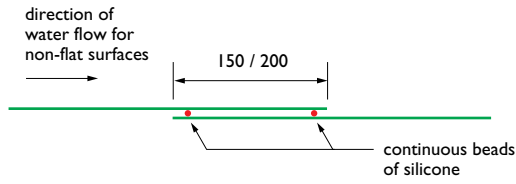

Flashing Straight Overlap

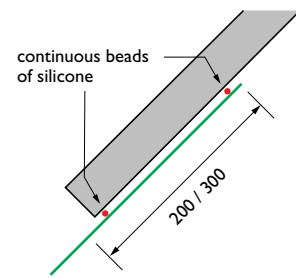

Sealed Roof Underlap (Soaker)

Other



Openings

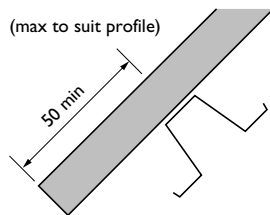

Sheet Overhang

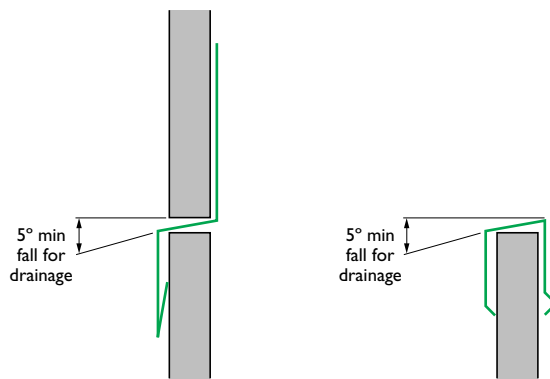

Drainage Allowance

Fixing

Flashing is generally fixed to cladding or other flashing sections using rivets or self-drilling screws. Fasteners close to folded edges generally cause the least distortion. Flashing edges beneath cladding normally only require nominal attachment to battens. Additional fixing may need to be considered in wind-exposed locations (eg. building corners).

General



Either timber or steel battens can be used



Indicates trough turn-up at sheet end

Large Roof Penetration

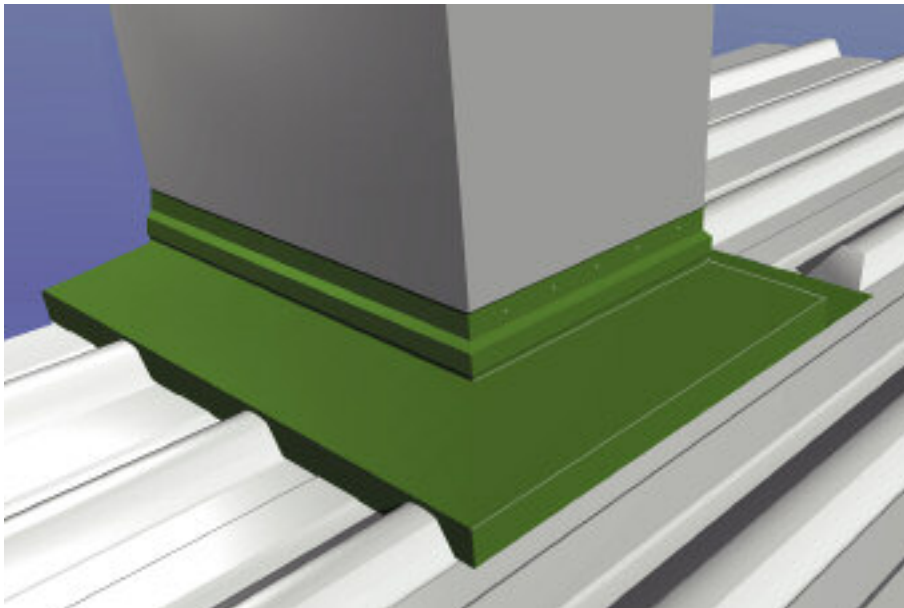

Large penetrations require considerable care in both flashing design and installation. The nature of the object penetrating the roof should be taken into consideration if it is subject to vibration, heat expansion, etc. Special attention is drawn to the need for an adequate drainage path at the front and sides of the penetrations. The position of the penetration should be well away from the low side of any sheet or step joint, ridge capping or parapet flashing. Where this is unavoidable use an overflashing between the penetration and the ridge or parapet. For roof sheet drainage design refer to the **Stramit® Roof Slope Design Guide**.

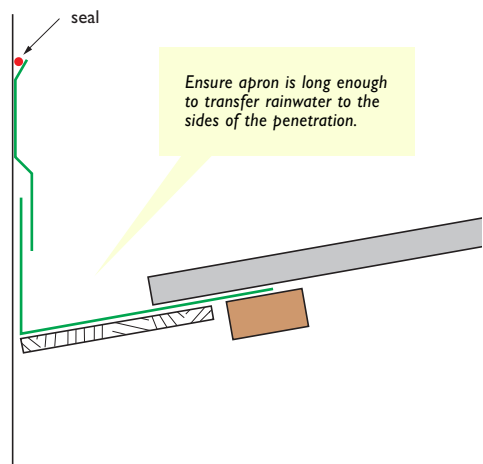
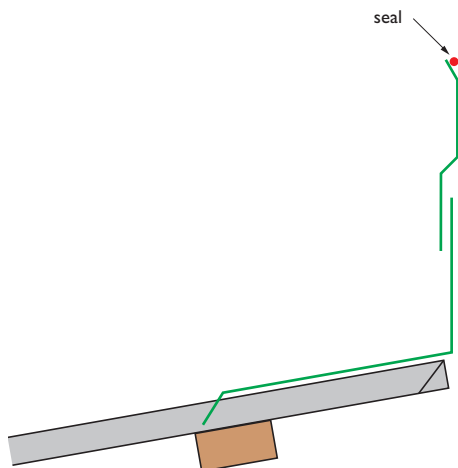

Small Roof Penetration

Smaller penetrations through roofs can be treated using the same principles as for larger penetrations. Proprietary flexible seals may be appropriate in some cases. It is important that these are installed in a manner that does not impede roof drainage or allow ponding. Roofing profiles with closely pitched ribs, eg., corrugated, invariably need a soaker arrangement to ensure adequate drainage.

Change of Pitch

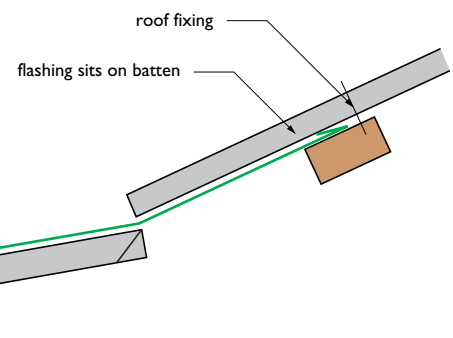
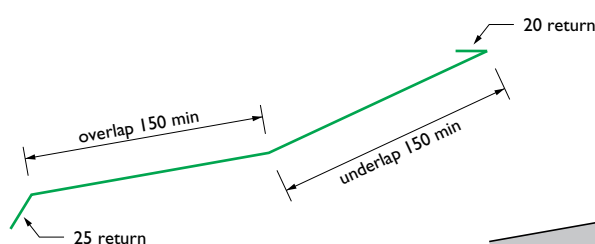

Ensure that the underlap length is sufficient to prevent wind-driven rain from entering. Similarly the roof sheet beneath the overlap must be turned up to avoid rain penetration.

Mansard

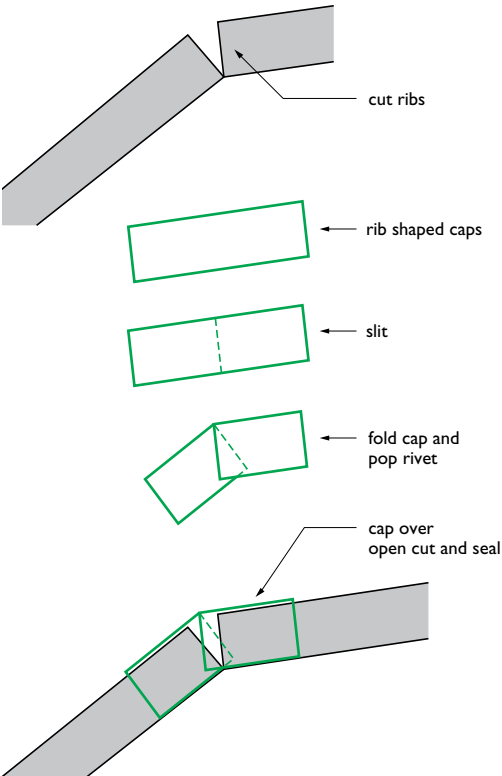
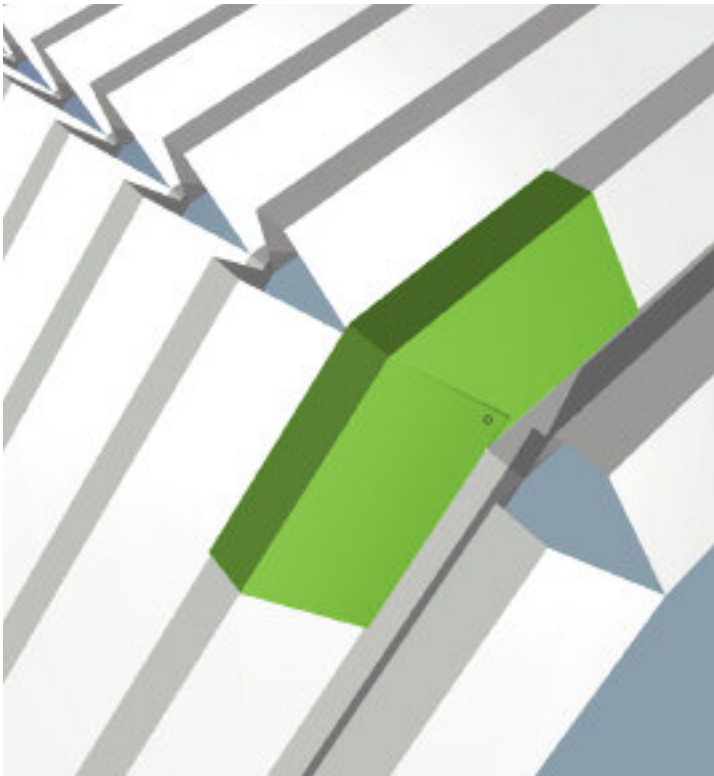

A mansard roof can be treated as a single sheet where the ribs are cut through, leaving the pans intact, with purpose-made caps covering the gaps in the ribs, as above. Alternatively, it can be considered as a change-of-pitch flashing as shown below.

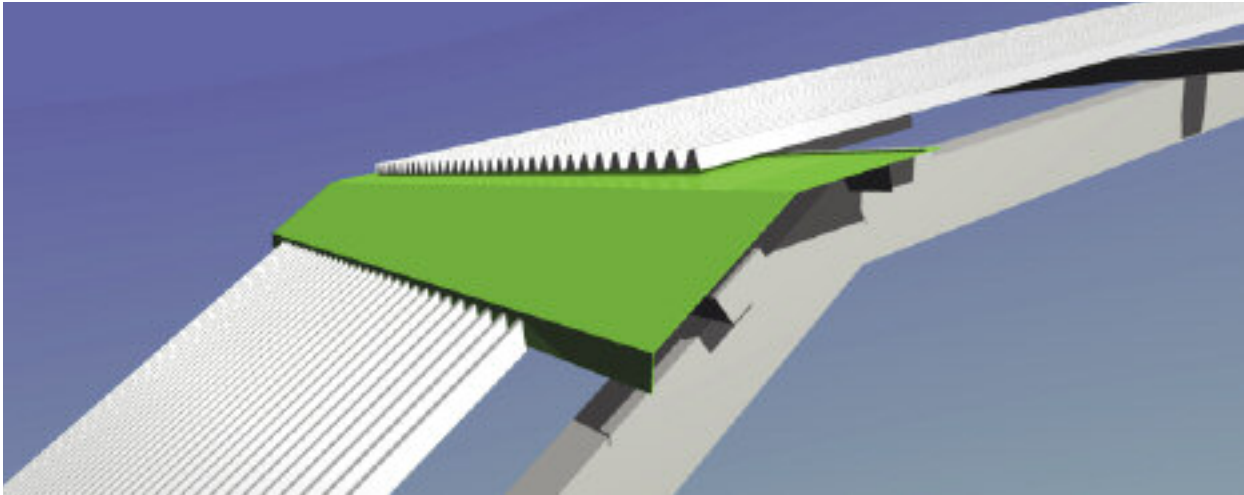

150mm is the recommended minimum overlap for slopes of 20° or less; for steeper pitches this may be reduced to as little as 50mm (in fully vertical applications).

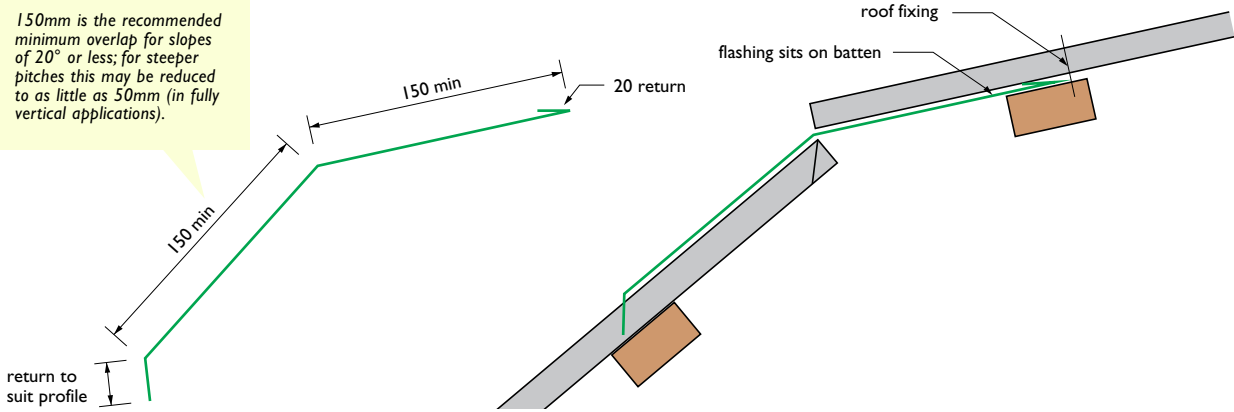

Expansion Joint

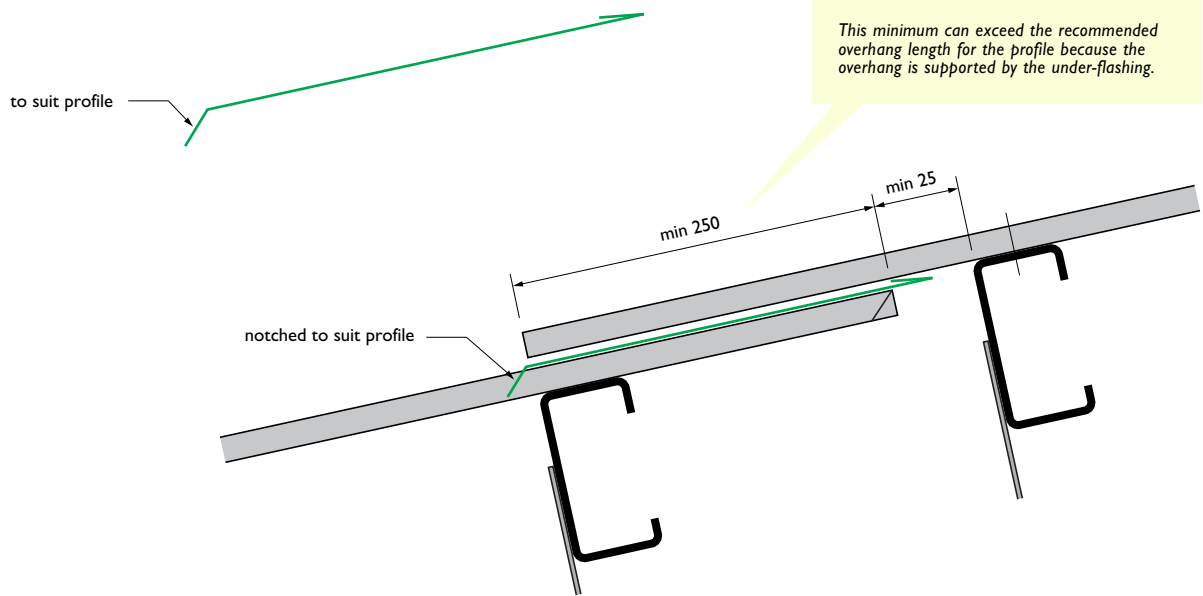

Expansion joints are incorporated into roof runs to reduce stresses on fastener connections. They are only required where the roof sheet length exceeds the values in the table below.

| MAXIMUM SHEET LENGTH (m) | | | |
|--------------------------|---------------|-----------------|------|
| | fixing method | sheeting colour | |
| | | light | dark |
| straight | through-fixed | 25 | 17 |
| | concealed | 35 | 25 |
| spring-curved | through-fixed | 20 | 17 |
| | concealed | 30 | 20 |

Note – temperature difference assumed to be 50°C for light colours and 75°C for dark.

Ridge Capping

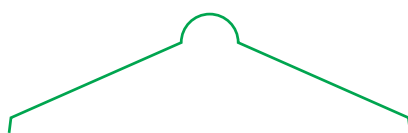

Roll-top ridge

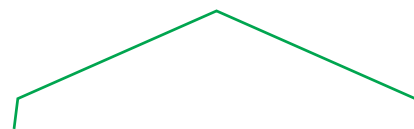

Plain or three-break ridge

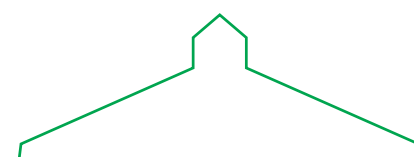
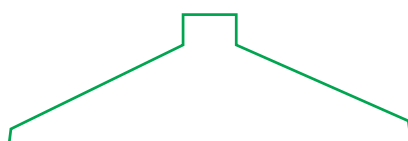

Stramit branches offer roll-top ridge and plain ridge as standard products. Other designs should be considered as custom flashings.

Raked Roof

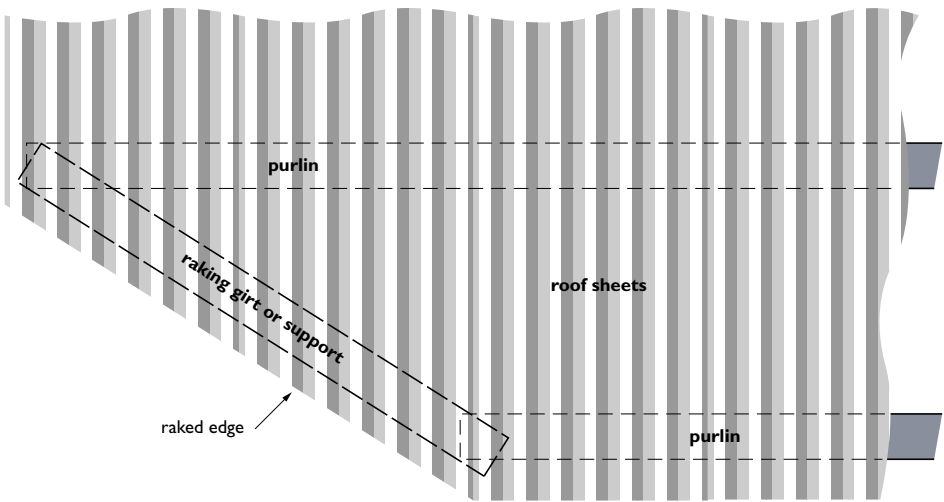

Raked roof edges occur where the roof sheet ends are cut at an angle to the line of the ribs. Some raked sheets will have insufficient end support from the purlins or battens. Where the overhang beyond the last supporting purlin exceeds the allowable overhang length for the profile, a sturdy support (eg. purlin or angle) must be provided. If flashing is used, such as a raking soaker, an underlap of 300mm or greater should be provided to prevent water penetration.

Box Gutter

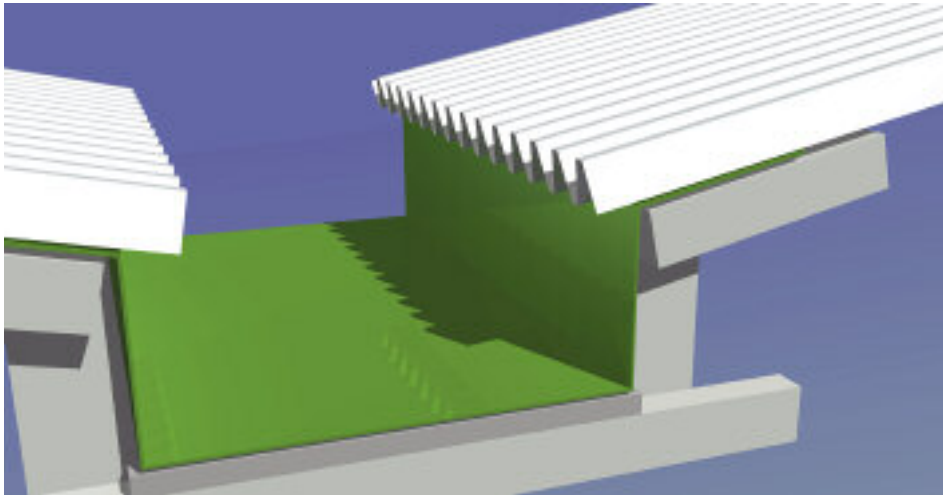

Box gutters have an important water drainage function and should be designed by an expert. Commercial box gutters must be at least 300mm wide and should be supported to allow for foot traffic during roof or service maintenance.

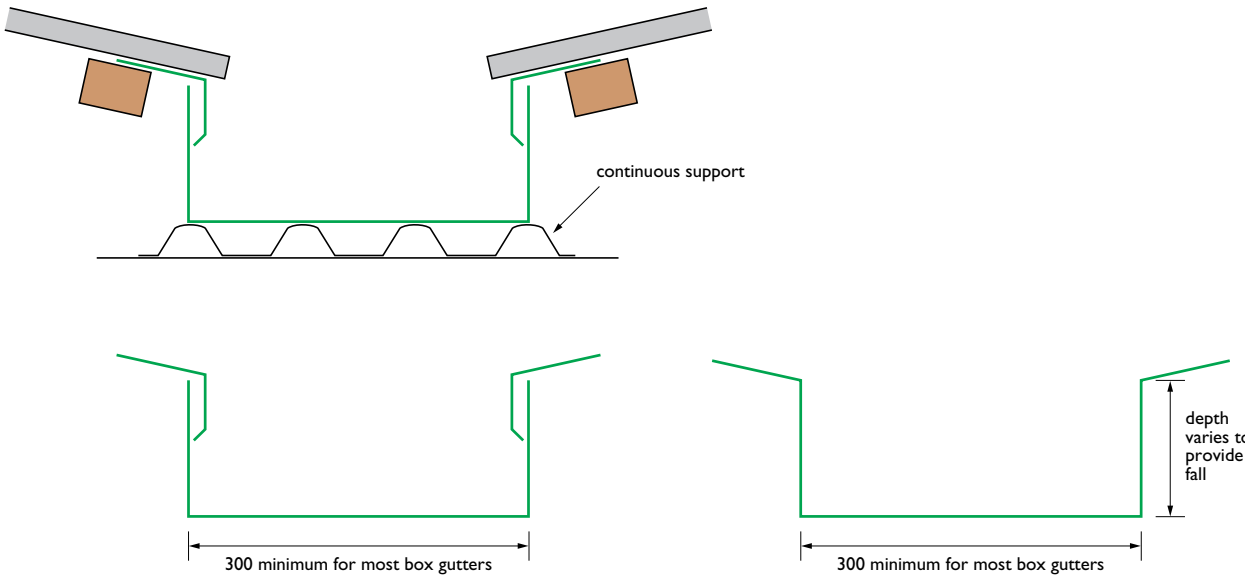

This options requires three sections of flashing. The top flashing should be deep enough to allow for fall in the box gutter.

This is a one-piece box gutter flashing with tapered side walls that increase in depth to provide drainage fall.

Barge Gutter

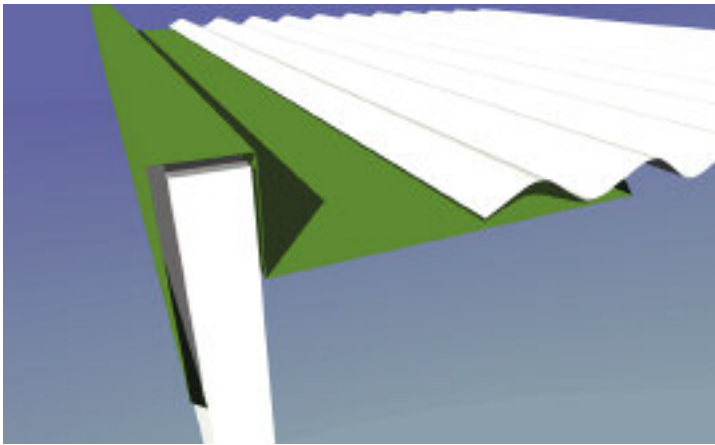

Barge gutters provide an alternative side detail for roofs, particularly tiled roofs. Usually these have only a limited drainage capacity, therefore avoid extra water flow from penetrations, etc.

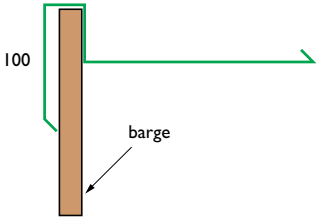

Barge Capping

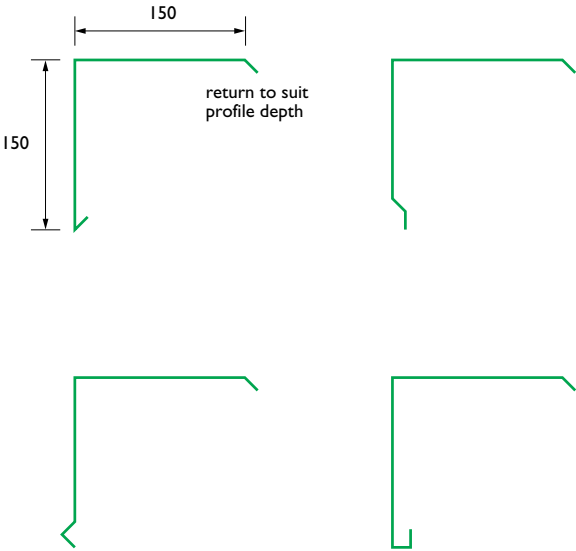
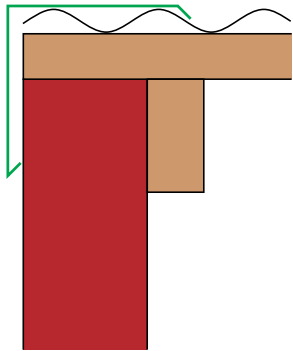

The most common sheet edge detail. Some Stramit branches offer standard barge capping to match square gutters.

Curved Barge

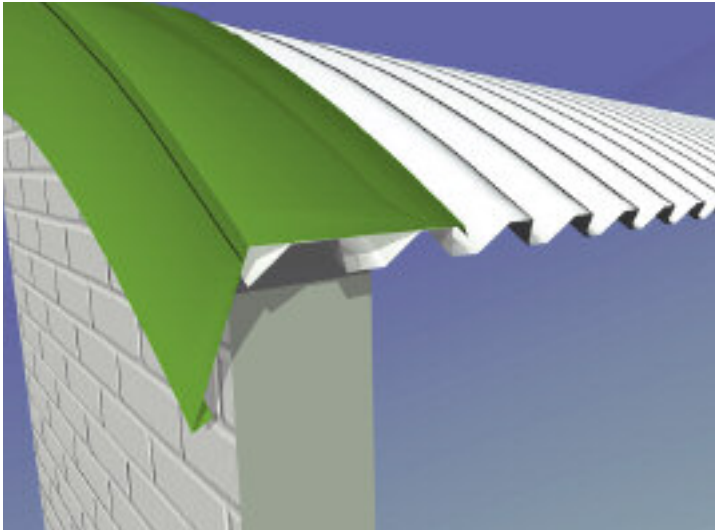

Curved sheet edges require a two-piece seamed barge capping.

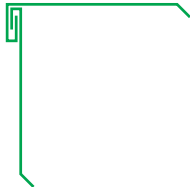

Parapet - Top

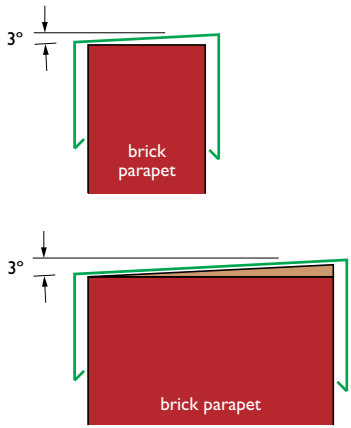
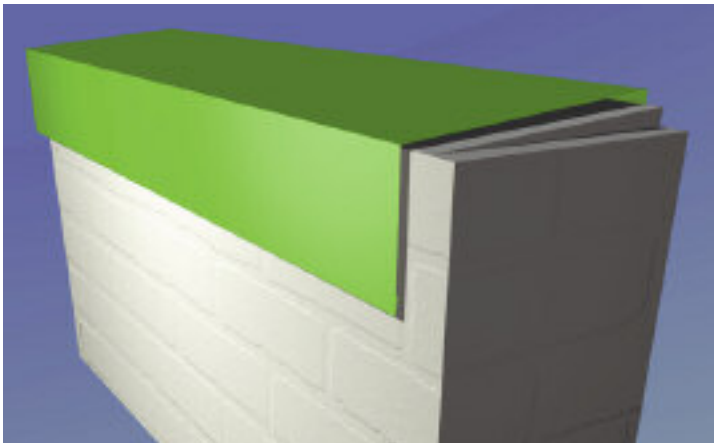

Parapet top flashing should be provided with a fall (minimum 3°) to avoid water ponding. For wider parapets, continuous support of the angled top surface may be required.

Parapet-to-Sheet Connection

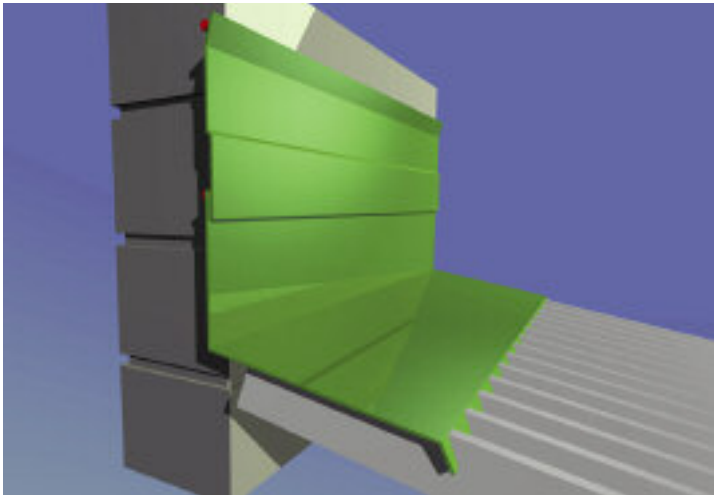

Parapet-to-sheet connections are often badly detailed and can be a cause of leakage. It is important that two overlapping sections of flashing are used, one attached to the parapet and one to the sheeting. Sealing is only required on the top section of flashing, which is not affected by thermal movement of the sheeting.

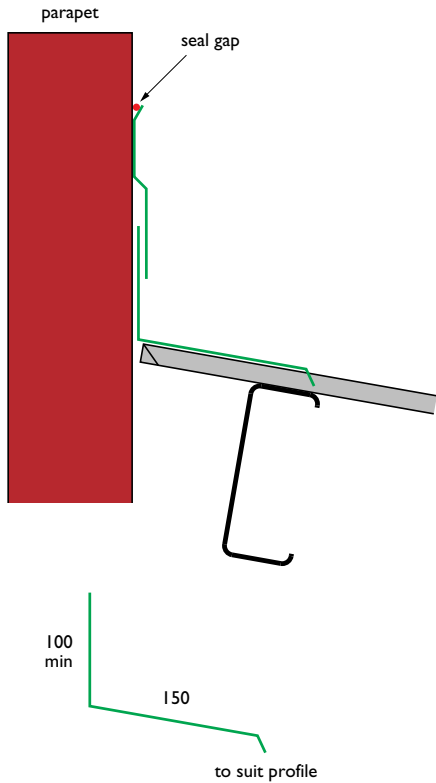
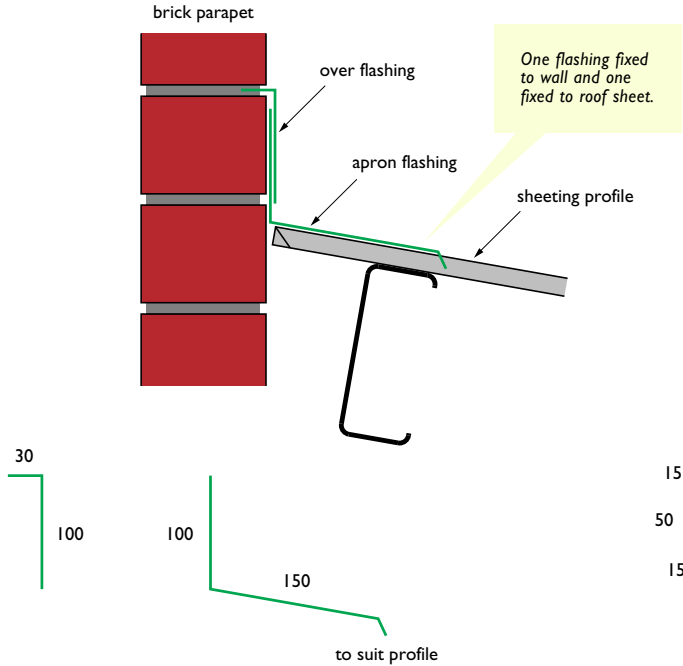

Mid-Wall Connections

Horizontal Sheeting Connections

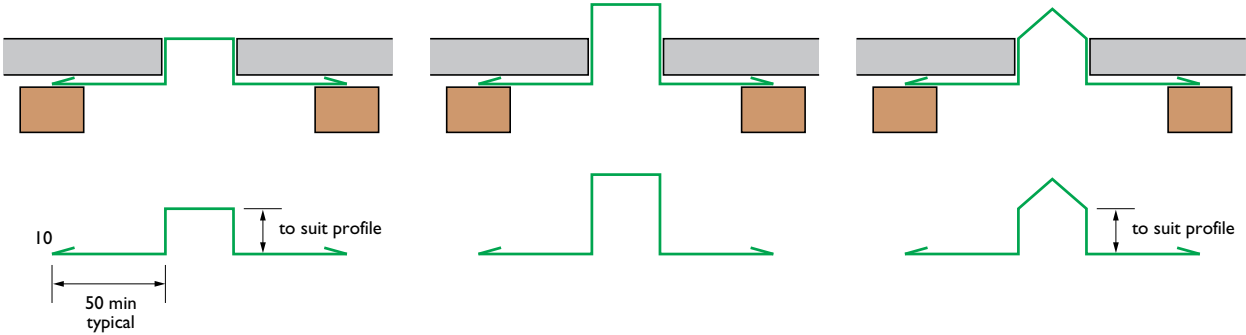
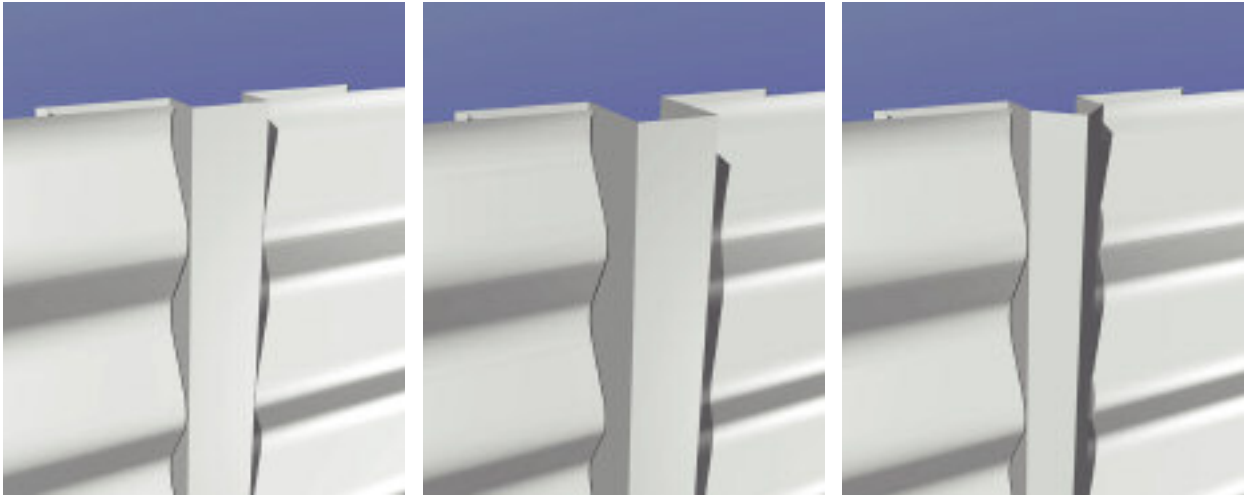

Above are three examples of mid-wall connections that make an attractive feature of horizontal sheeting joints. This type of connection joint is also reliable and easy to install. The best effect is generally achieved when the connections are spaced regularly along the wall. A typical spacing of 4 to 6 metres is particularly effective.

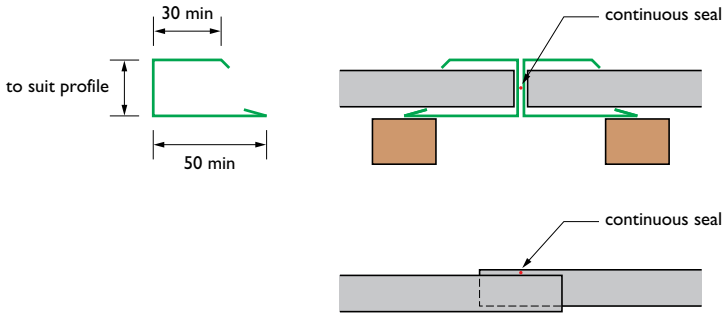

These alternative connections for horizontal sheeting require continuous sealing to maintain weather tightness.

Simple sheet overlap – only suitable for **Stramit® Corrugated**, **Stramit Longspan®**, **Stramit Mono-clad®** or **Stramit Mega-clad®** sheeting (not recommended if total combined sheet length exceeds 20 metres).

Vertical Sheeting Connection

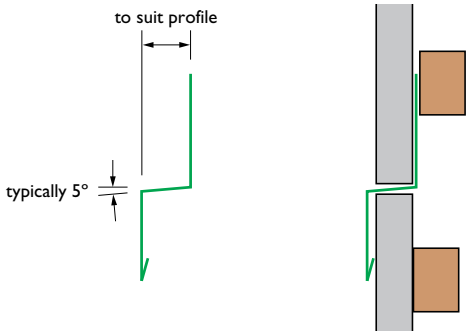

Internal Corner - Trim

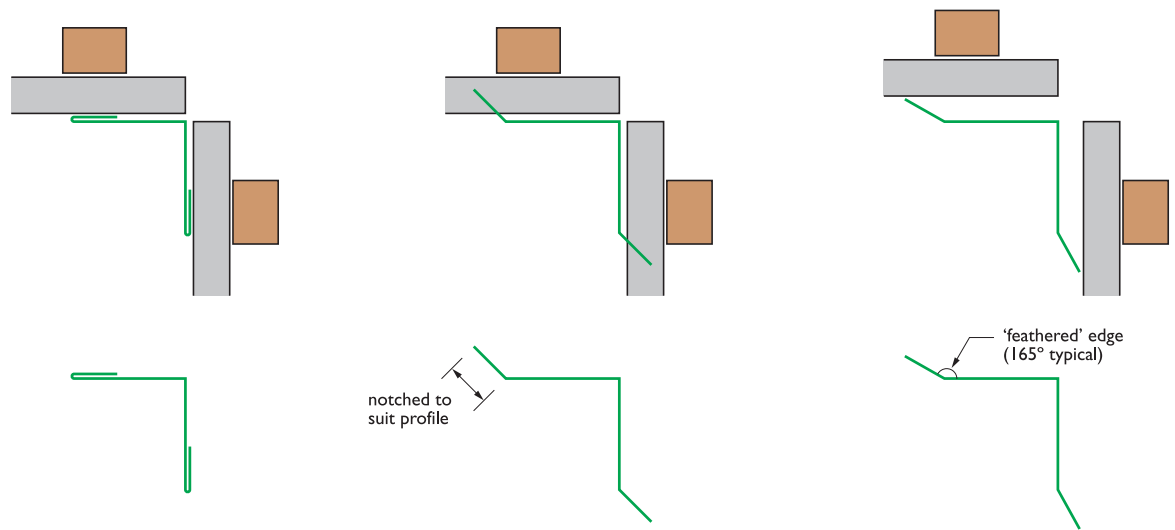

Internal corners can be treated with a simple trim for weather tightness or with a three-dimensional moulding for aesthetic effect. Internal corner trim may be used in vertical walling applications inside or outside a building. For internal corners with horizontal sheeting this trim should only be used inside a building (if exposed to the weather there is a risk of wind-blown rain penetrating the flashing). If appearance and function are equally important in a weather-exposed horizontal sheet application, the trim can be combined with an additional plain moulding to provide protection against rain penetration.

Internal Corner - Moulding

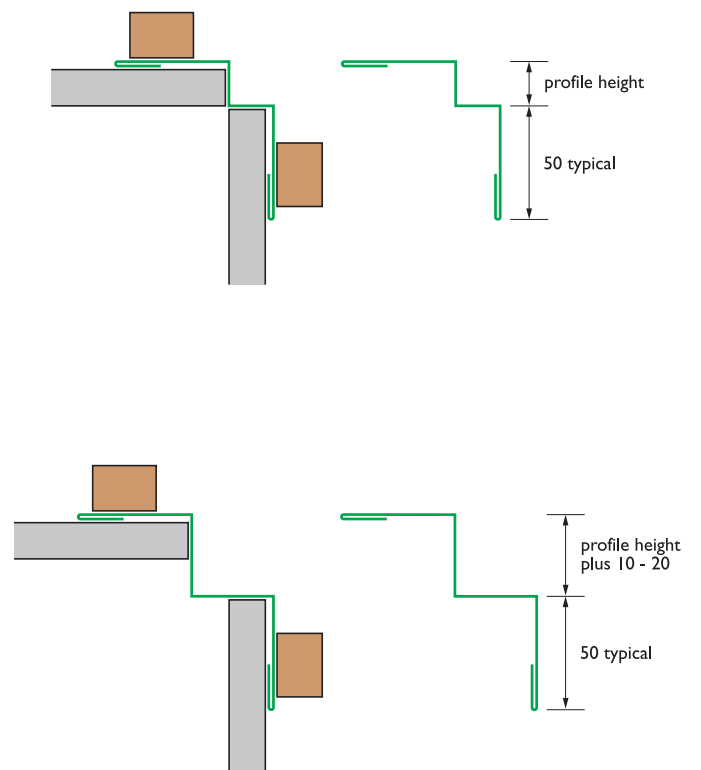
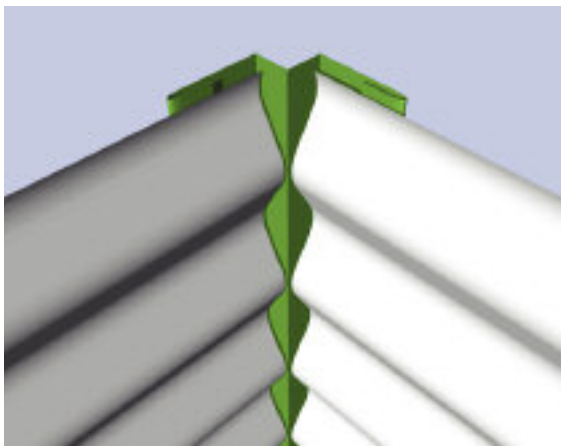

Internal corner mouldings may be used for inside or outside applications but are generally only used with horizontal sheeting. From the illustrations, it can be seen that a flashing with a step depth equal to the profile height relies on perfect alignment of sheeting on adjacent walls. Where the step depth is increased beyond the profile height, as in the lower illustration, the exposed flashing masks slight misalignments and provides a clean vertical edge that visually dominates the corner.

External Corner - Trim

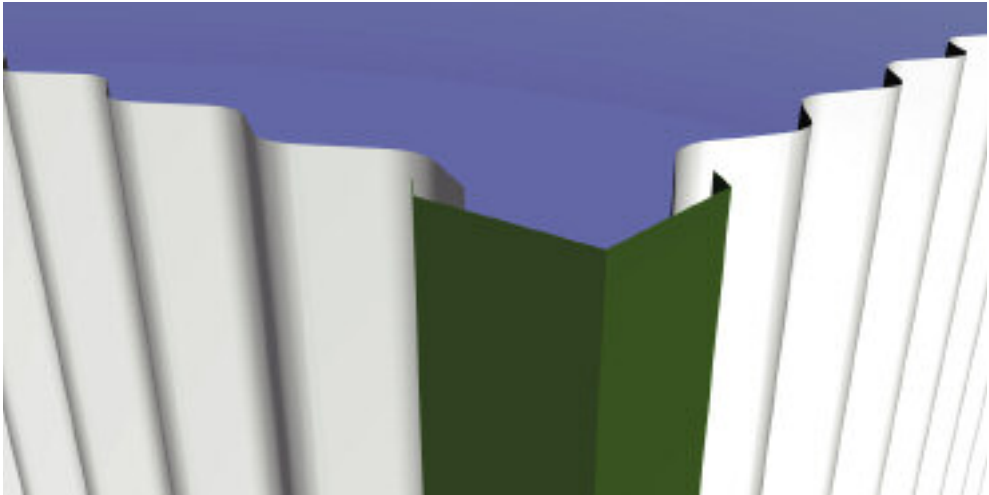

External corner trim shown with vertical **Stramit**® Corrugated sheeting.

External corner trims can take a number of forms, several of which are illustrated. Most can be used with either horizontal or vertical sheeting applications.

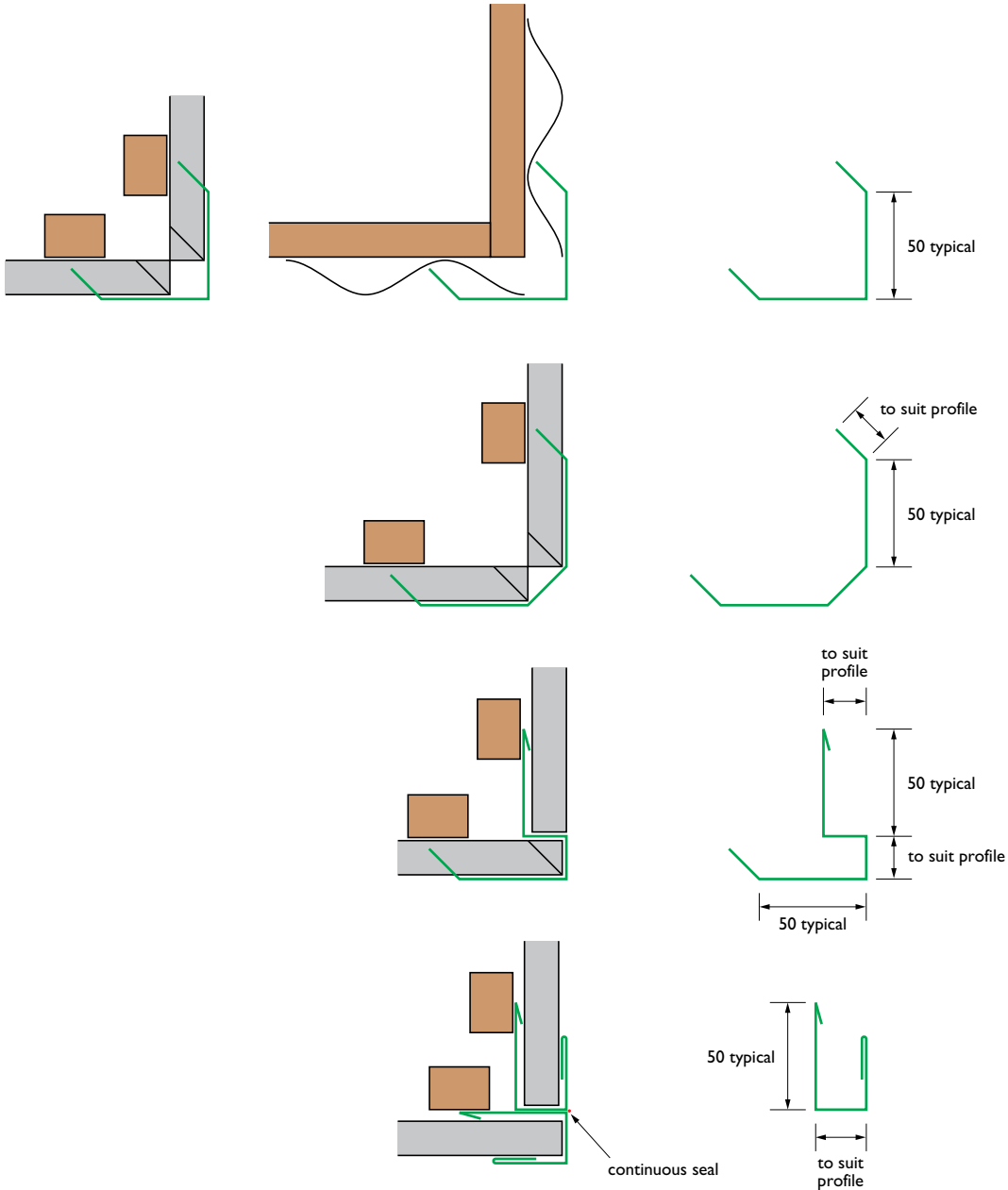

External Corner - Moulding

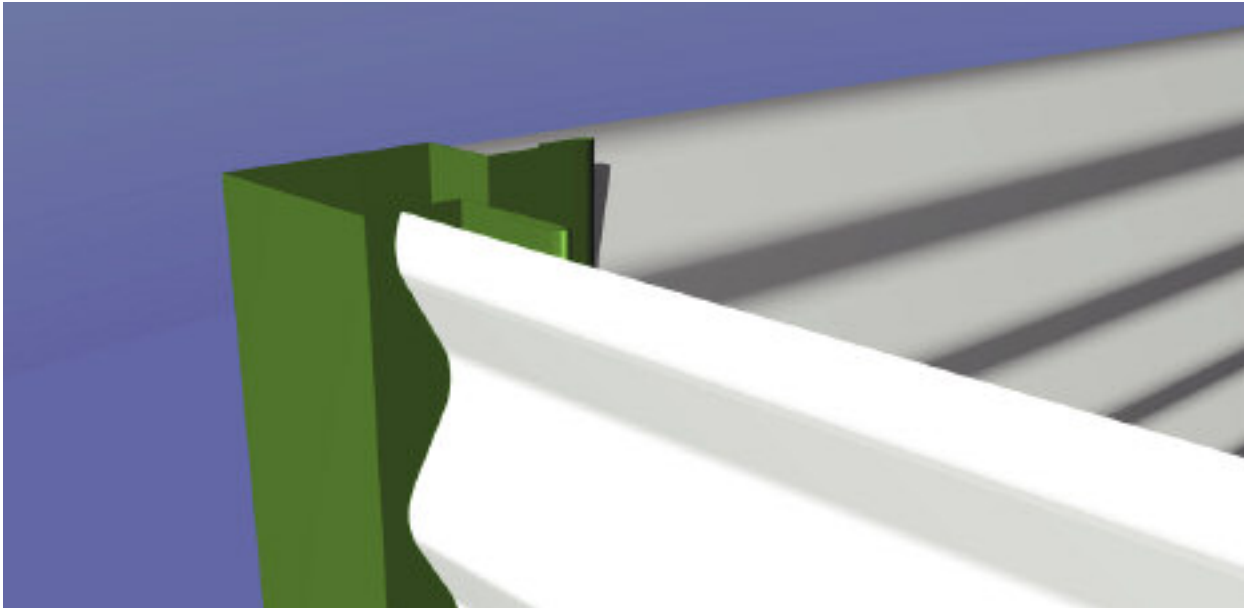

Flashing formed into a three-dimensional moulding provides an attractive finish on external corners, particularly with horizontal wall sheeting. A step depth greater than the profile height provides added protection to the sheet ends and is recommended for pedestrian areas.

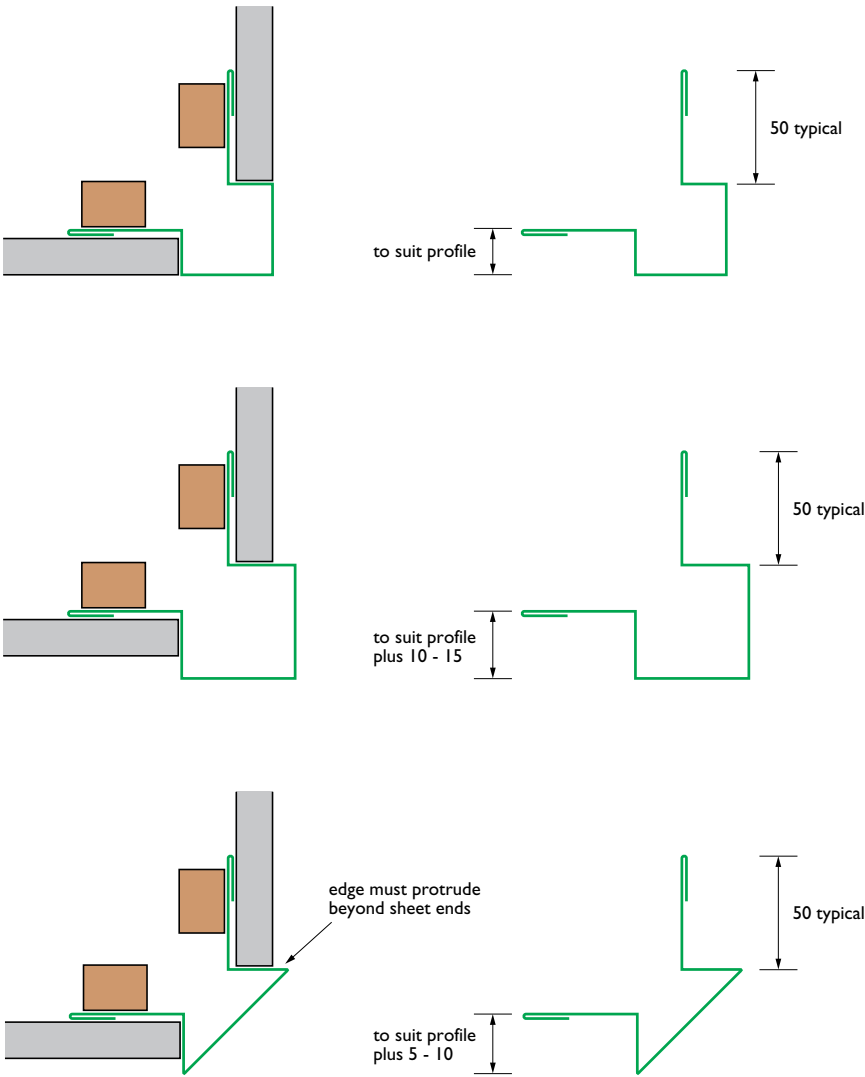

Wall to Eaves/Soffit

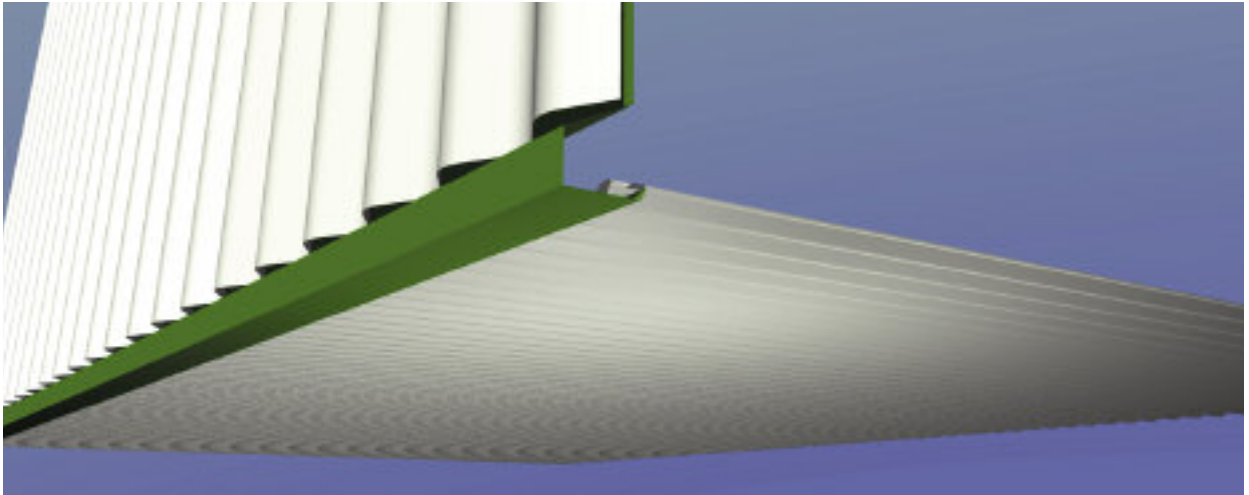

Typical flashing details for various wall, soffit and fascia intersections.

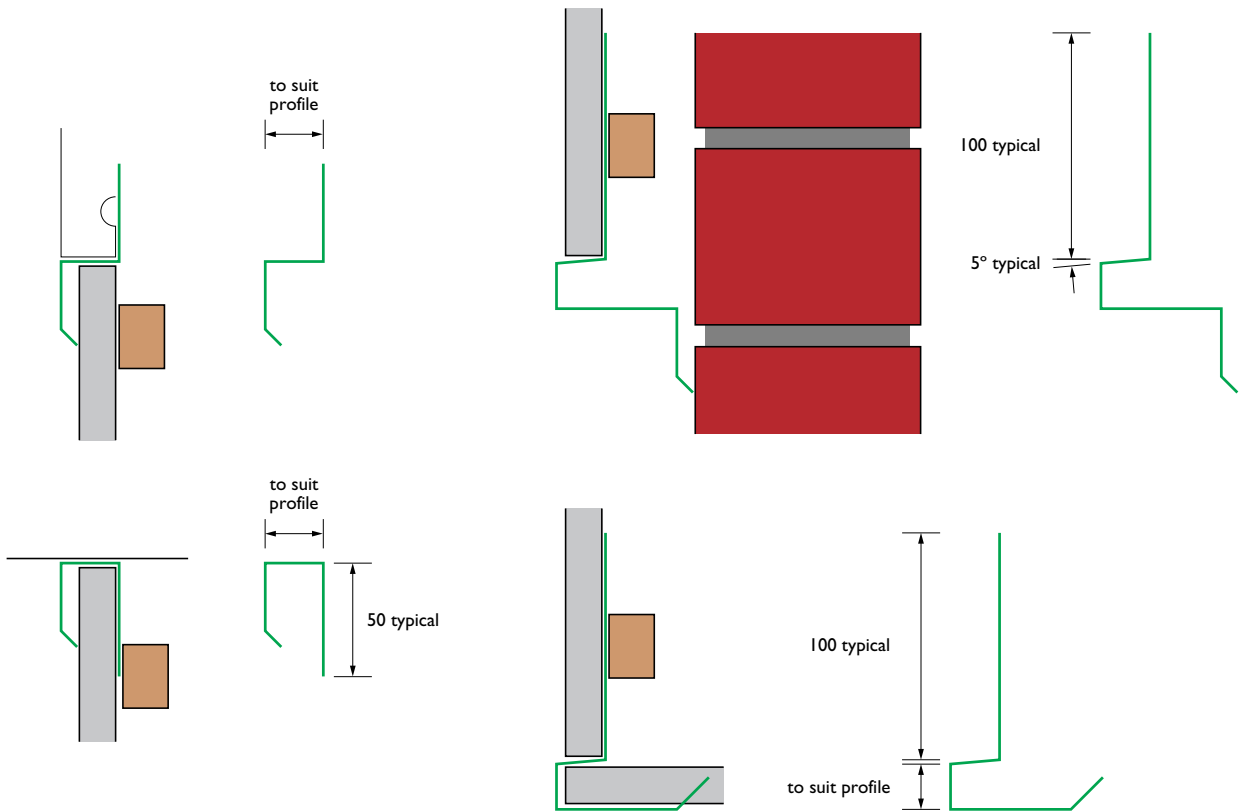

Fascia Purlin

A typical **Stramit**® Fascia Purlin. These are generally of a standard design but may vary slightly between regions.

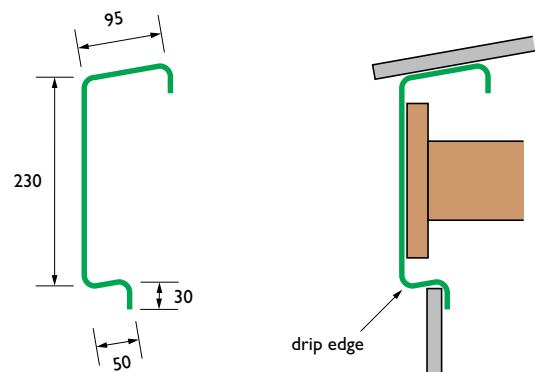

Bottom of Wall

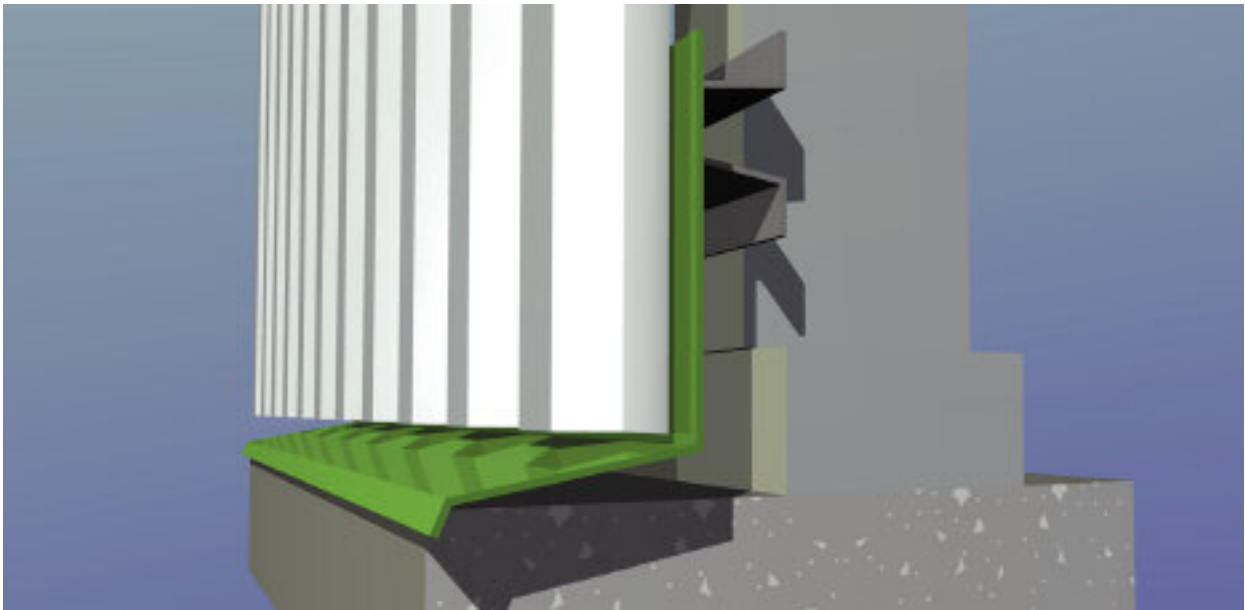

Flashing at wall footings should include a fall on 'horizontal' planes and be of sufficient size to ensure good drainage away from the sheeting and to avoid potential build-up of debris.

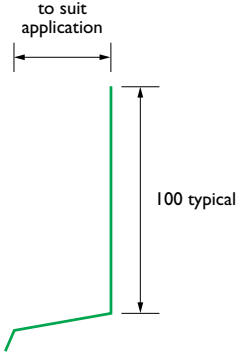
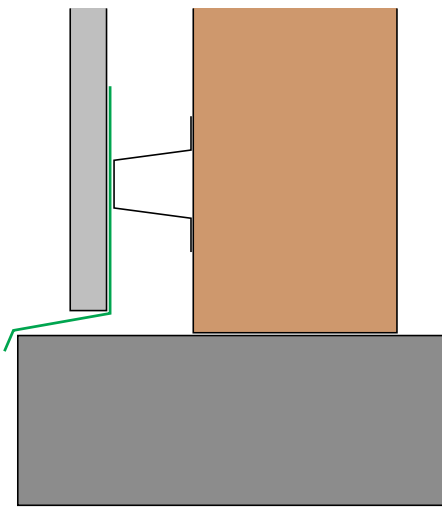
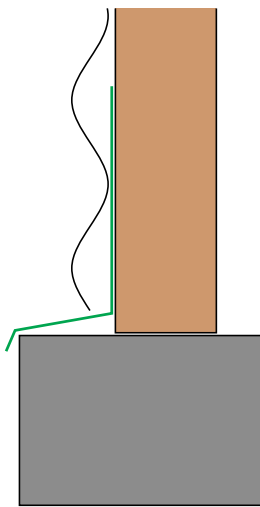

Material choice for this flashing is important as water will regularly drip on to flashing from wall cladding.

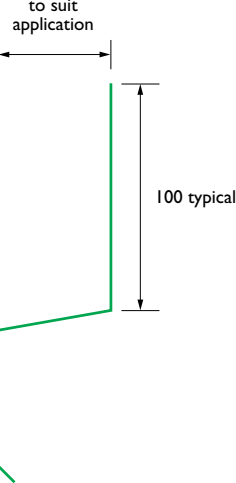
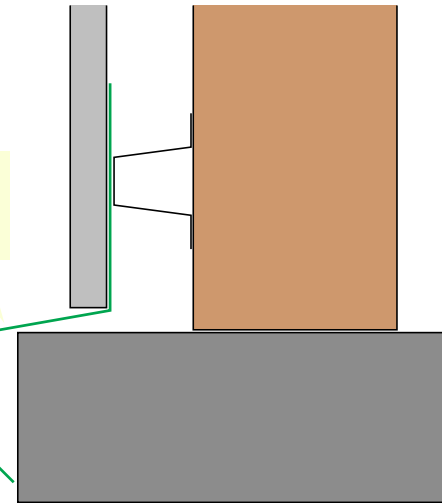

Window / Door

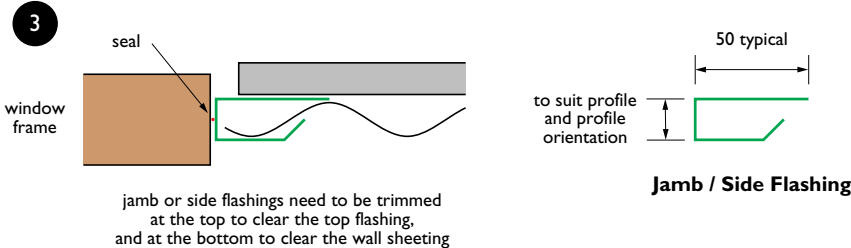
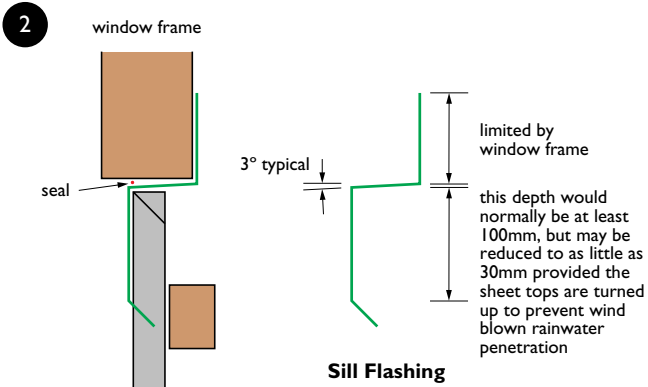
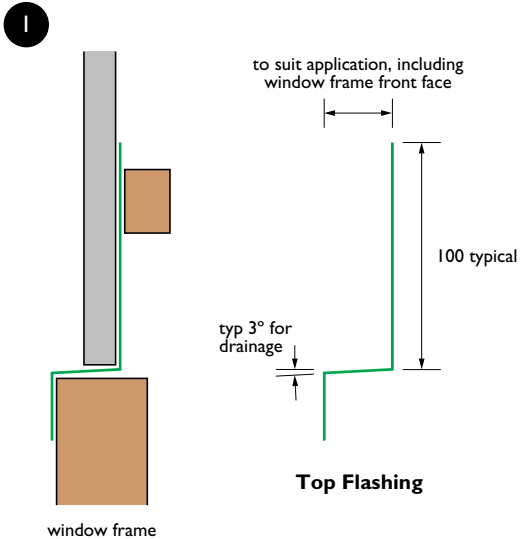
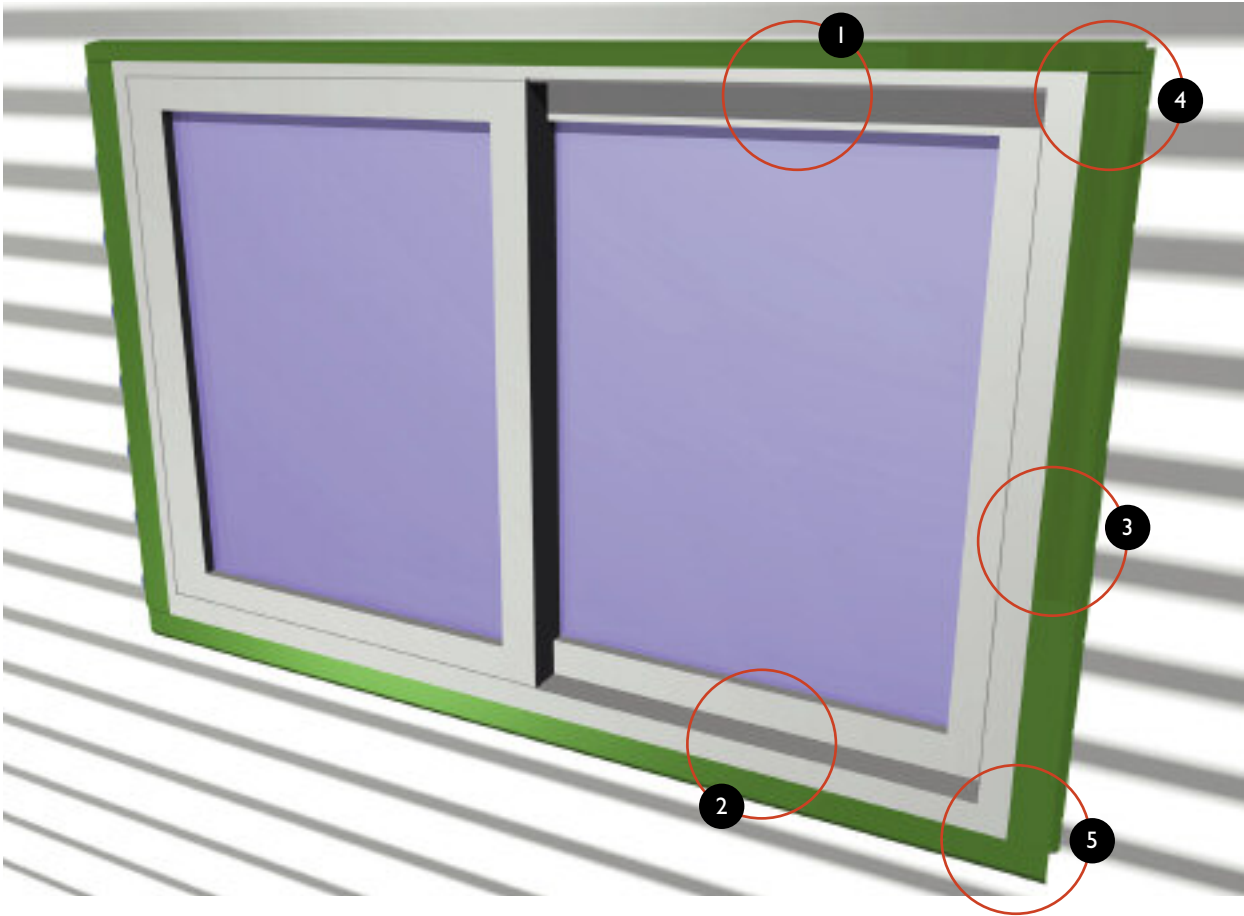

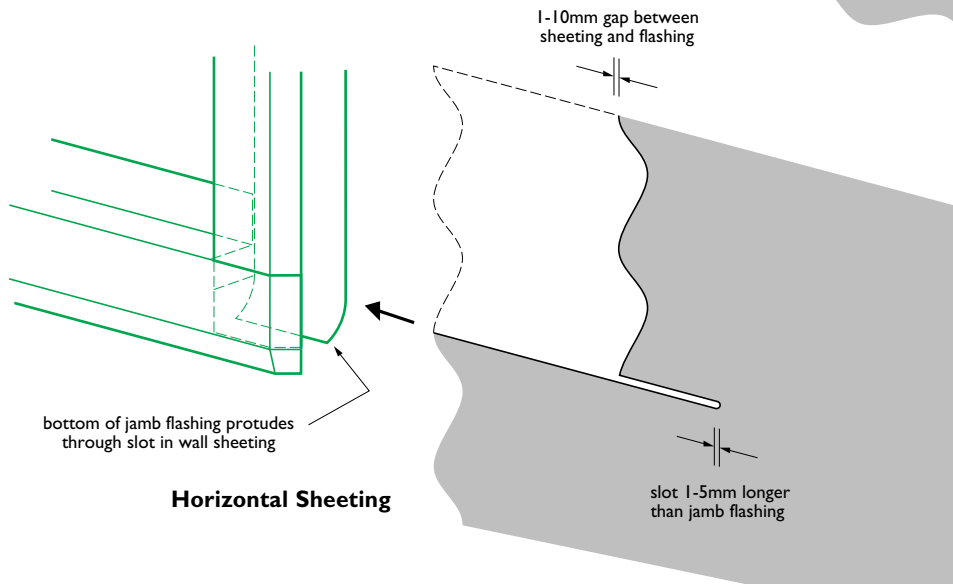
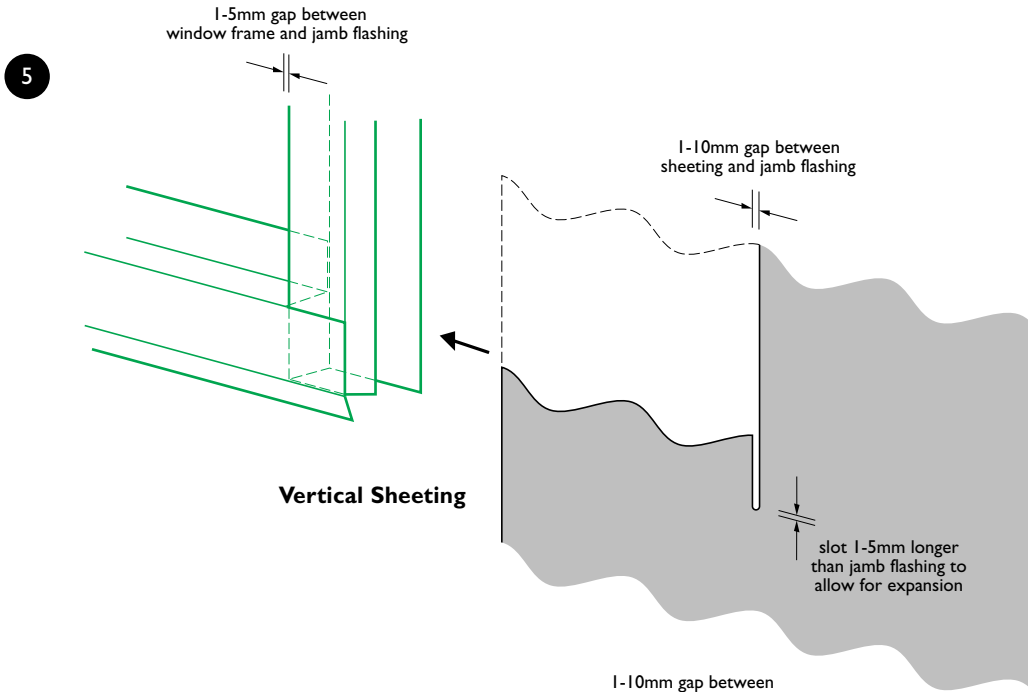
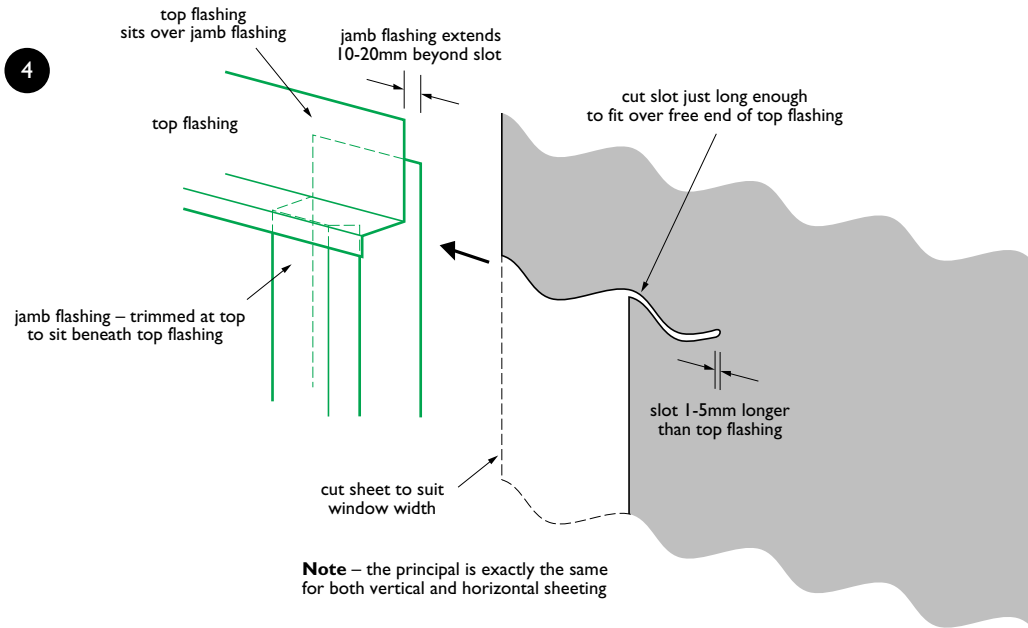

Wall Penetrations

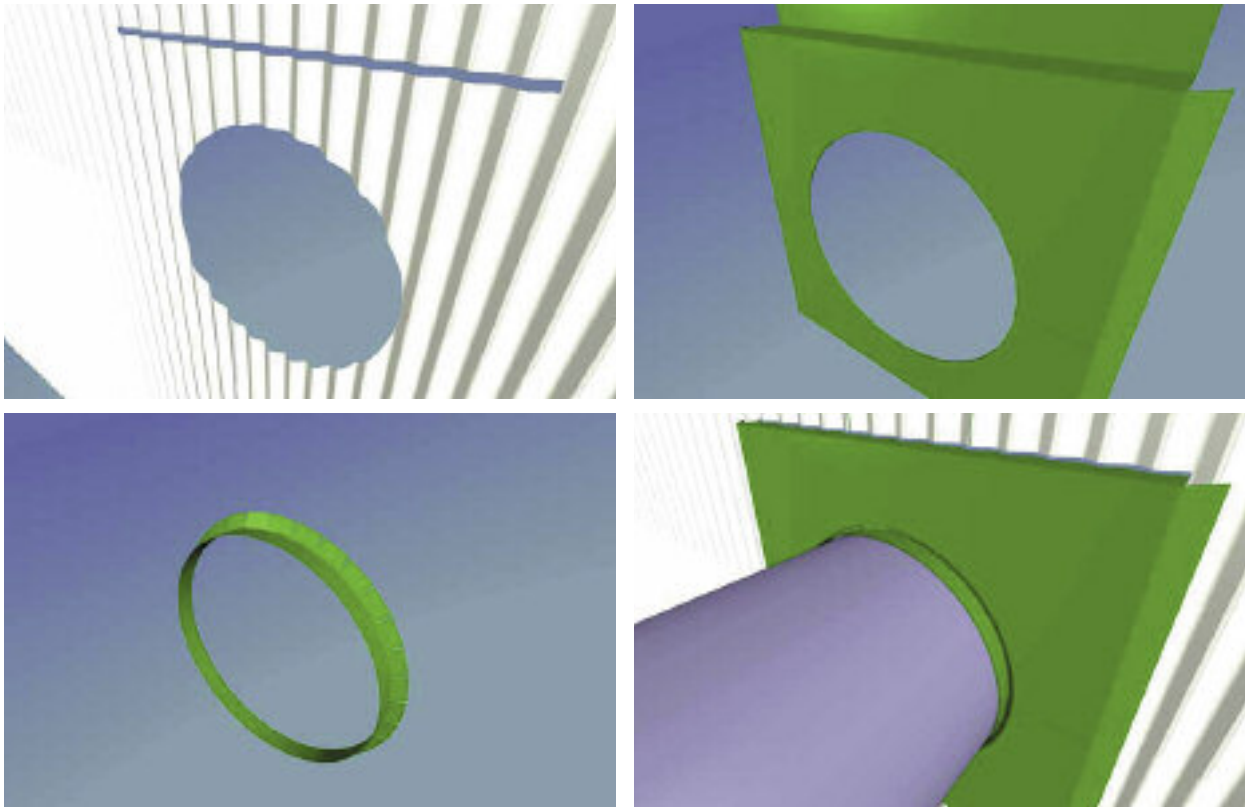

Larger wall penetrations can be treated in a number of ways. One option starts with a clearance hole for the penetrating object plus a slot placed above (and wider than) the hole. With this arrangement the flashing remains outside the wall sheeting except above the slot.

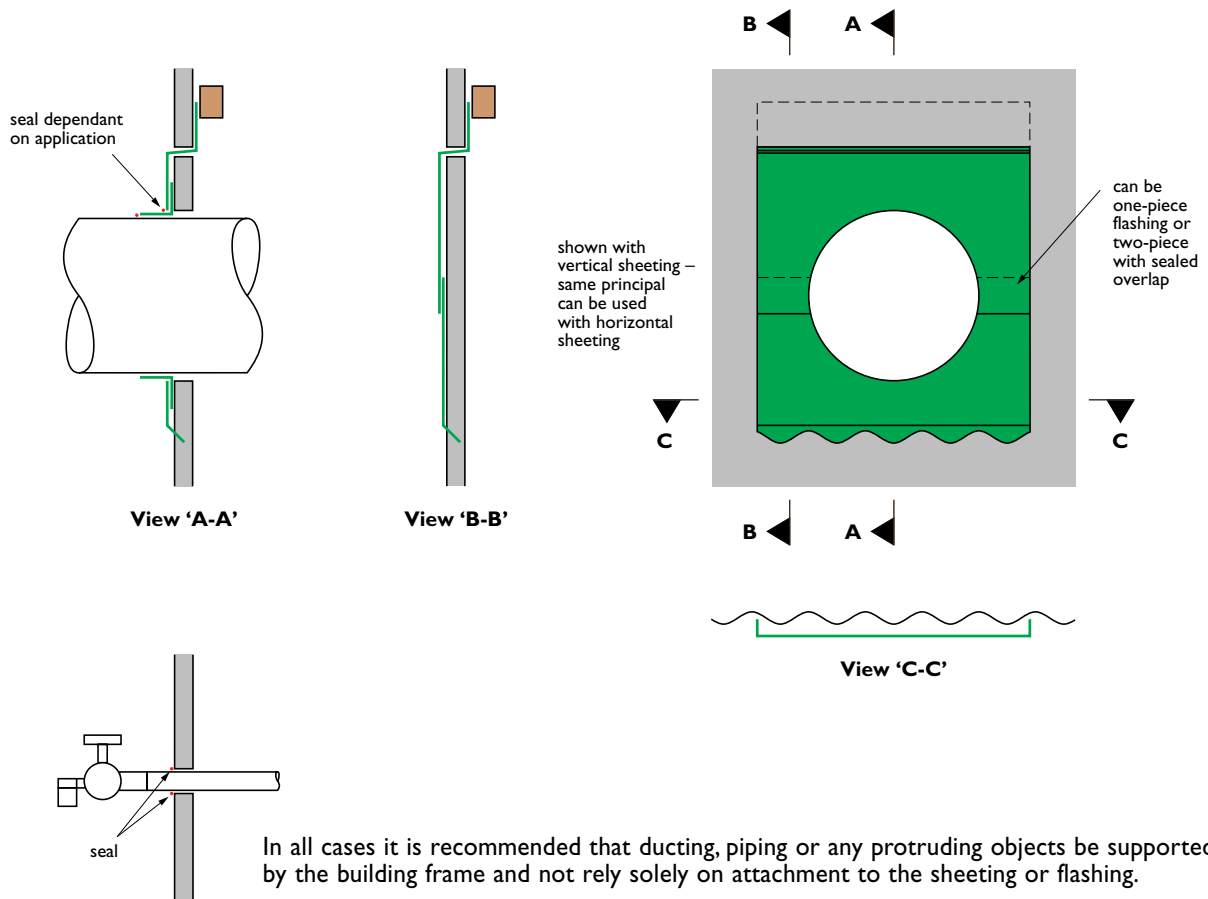

In all cases it is recommended that ducting, piping or any protruding objects be supported by the building frame and not rely solely on attachment to the sheeting or flashing.

Stramit® Product Range

Stramit offers a comprehensive range of building products throughout Australia. These include:

- Roof sheeting
- Roof decking
- Wall cladding
- Purlins and girts
- Top hats and battens
- Specialist rainwater goods
- Composite slab decking

Other Stramit Literature

In addition to individual technical manuals for all products or product groups, Stramit offers a range of Design Guides to assist architects, engineers and specifiers:

- Limit-State Design
- Roof System Selection
- Concealed Fixed Decking
- Roof Slope
- Foot Traffic (on metal roofs)
- Spring Curving
- Premium Materials and Finishes

Please contact your nearest Stramit office to obtain copies of these items.



The Stramit web page can be found at:

www.stramit.com.au

Details of many **Stramit**® products can also be seen on the AIA site 'Product Selector' at:

www.selector.com.au

Building Products

contact numbers for information

| | | prices | availability | general | technical |
|--|--------------|---|---|---|---|
| | | | products coating colours | other | advice product data |
| SYDNEY 33-83 Quarry Road, Erskine Park NSW 2759 | phone fax | (02) 9834 0909 (02) 9834 0988 | | (02) 9834 0900 (02) 9834 0988 | |
| CANBERRA 4 Bass Street, Queanbeyan NSW 2620 | phone fax | | (02) 6297 3533 (02) 6297 8089 | | |
| COFFS HARBOUR 6 Mansbridge Drive, Coffs Harbour NSW 2450 | phone fax | | (02) 6652 6333 (02) 6651 3395 | | (02) 4954 5033 (02) 4954 5856 |
| NEWCASTLE 17 Nelson Road, Cardiff NSW 2285 | phone fax | | (02) 4954 5033 (02) 4954 5856 | | |
| ORANGE 51 Leewood Drive, Orange NSW 2800 | phone fax | | (02) 6361 0444 (02) 6361 9814 | | |
| MELBOURNE 2/1464 Ferntree Gully Road, Knoxfield VIC 3180 | phone fax | (03) 9237 6300 (03) 9237 6399 | | (03) 9237 6200 (03) 9237 6299 | |
| ALBURY 18 Ariel Drive, Albury NSW 2640 | phone fax | | (02) 6041 7600 (02) 6041 7666 | | |
| BENDIGO Ramsay Court, Kangaroo Flat VIC 3555 | phone fax | | (03) 5448 6400 (03) 5447 9677 | | |
| MILDURA 19 - 23 Adams Street, Mildura VIC 3500 | phone fax | | (03) 5018 4800 (03) 5021 0557 | | |
| HOBART 57 Crooked Billett Drive, Brighton TAS 7030 | phone fax | | (03) 6263 5536 (03) 6263 6950 | | (03) 6263 5536 (03) 6263 6950 |
| LAUNCESTON 289 Hobart Road, Kings Meadows TAS 7249 | phone fax | | (03) 6343 7390 (03) 6343 7381 | | |
| ADELAIDE 11 Stock Road, Cavan SA 5094 | phone fax | | (08) 8262 4444 (08) 8262 6333 | | (08) 8262 4444 (08) 8262 6333 |
| BRISBANE 57-71 Platinum Street, Crestmead QLD 4132 | phone fax | | (07) 3803 9999 (07) 3803 1499 | | |
| TOWNSVILLE 402-408 Bayswater Road, Garbutt QLD 4814 | phone fax | | (07) 4779 0844 (07) 4775 7155 | | |
| CAIRNS Vickers Street, Edmonton QLD 4869 | phone fax | | (07) 4045 3069 (07) 4045 4762 | | |
| MACKAY Brickworks Court, Glenella QLD 4740 | phone fax | | (07) 4942 3488 (07) 4942 2343 | | (07) 3803 9999 (07) 3803 1499 |
| MARYBOROUGH 10 Activity St, Maryborough QLD 4650 | phone fax | | (07) 4121 2433 (07) 4123 3139 | | |
| ROCKHAMPTON 41 Johnson St, Parkhurst QLD 4702 | phone fax | | (07) 4936 2577 (07) 4936 4603 | | |
| SUNSHINE COAST Unit 1, 5 Kerryl St, Kunda Park QLD 4556 | phone fax | | (07) 5456 4083 (07) 5456 4862 | | |
| MURWILLUMBAH 6 Kay Street, Murwillumbah NSW 2484 | phone fax | | (02) 6672 8542 (02) 6672 6798 | | |
| DARWIN 55 Albatross Street, Winnellie NT 0820 | phone fax | | (08) 8947 0780 (08) 8947 1577 | | |
| PERTH 605-615 Bickley Road, Maddington WA 6109 | phone fax | | (08) 9493 8800 (08) 9493 8899 | | |

® Registered trademarks of Stramit Corporation Pty Limited. ABN 57 005 010 195 trading as Stramit Building Products

A member of the Fletcher Building Group

COLORBOND® and ZINCALUME® are registered trademarks of BlueScope Steel Limited

© Stramit Corporation Pty. Limited December 2011.

This document replaces all previous issues. Please destroy, or clearly mark as superseded, all previous issues.