

TREX



TREX pavement
Installation guideline



Built to Outlast.
Designed to
impress.

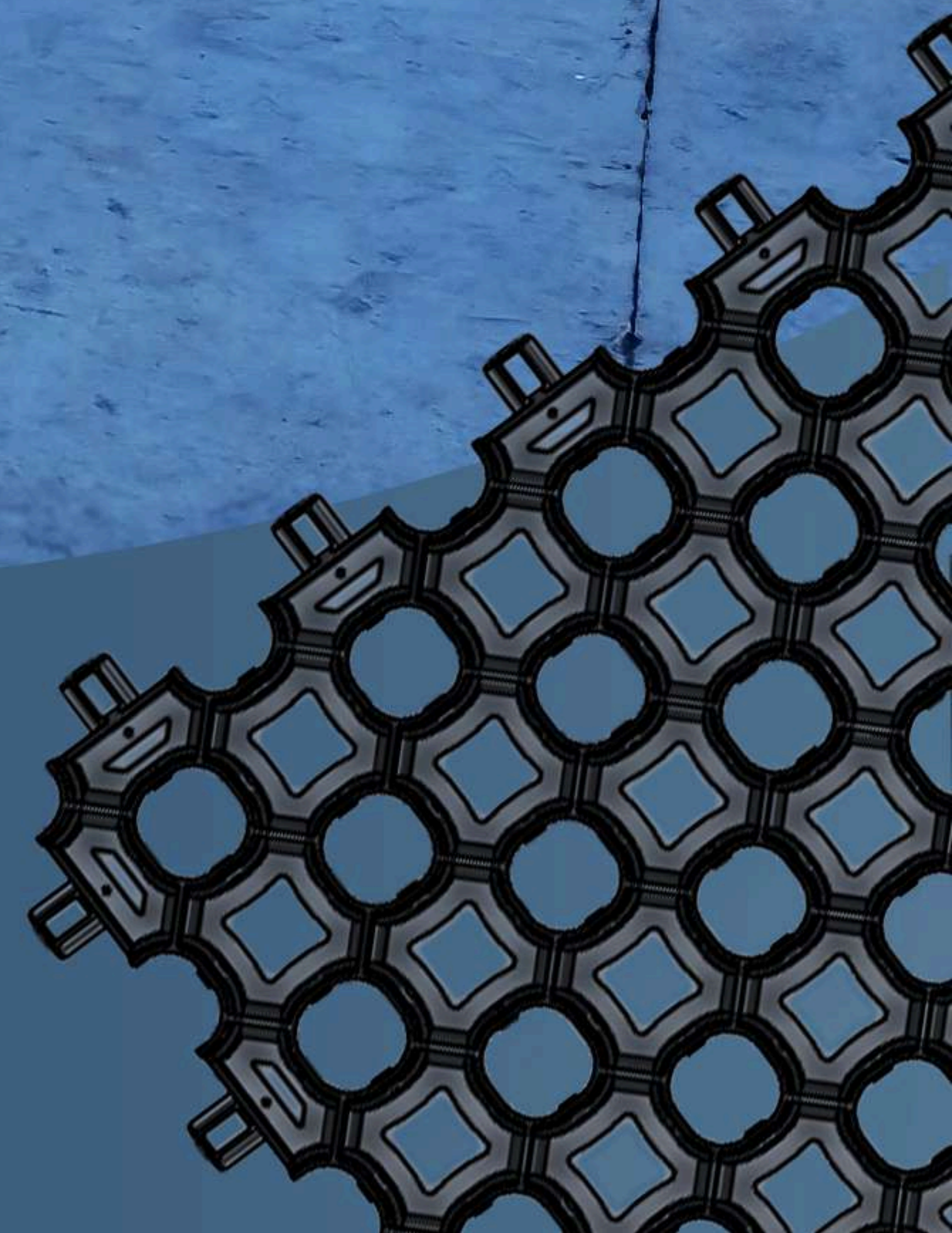
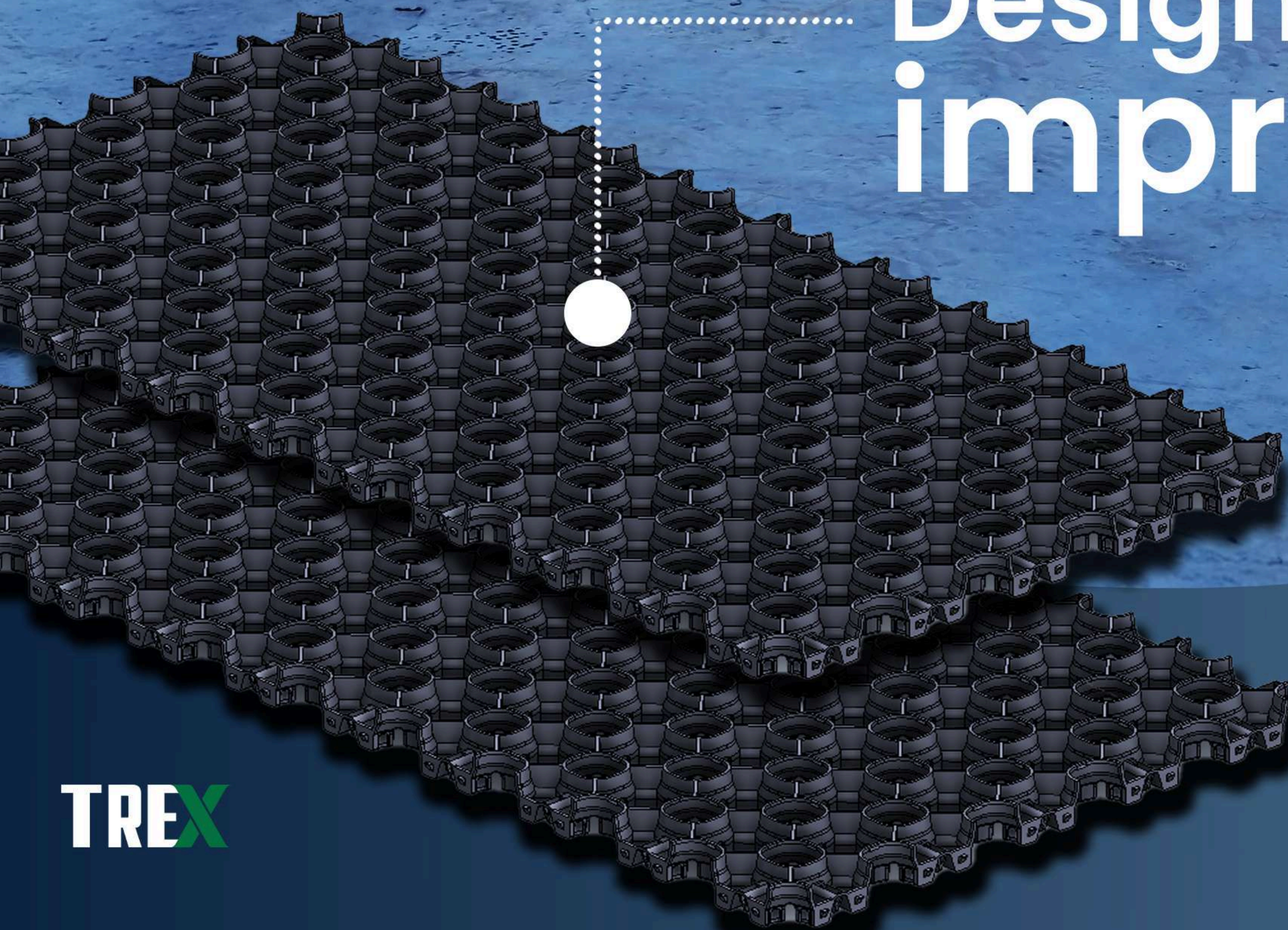

TREX

Contents 

TREXLOK Specifications	2
TREXPAVE Specifications	3
Subbase Preparation Guide	4
Concrete Pavements with TREXLOK	5
Subgrade Preparation	5
Subbase Preparation	5
Edging for Concrete Pavements	6
Implementation of TREXLOK	7
Concrete Fill and Finish of TREXLOK	8
Permeable Pavement with TREX	9
Implementation of TREX	10
TREX Fill Application	11
TREXSPOT Pavement Dileanators	12
TREX Handling Precautions	13



TREXLOK

Specifications

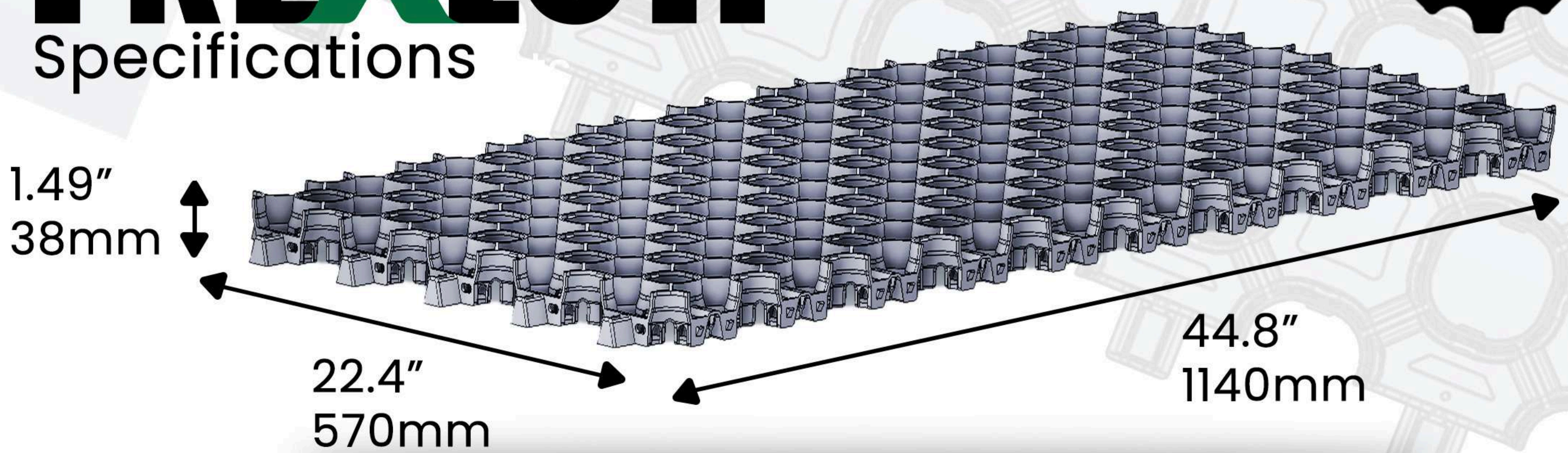

- Measurements ▶ 44.8" W x 22.4" L x 1.49" H - 1140mm W x 570mm L x 38mm H
- Weight per grid ▶ 5.97 lbs - 2.7kg
- Fill ratio ▶ 1 cubic yard of fill per 207.9 square feet - 1 cubic meter of fill per 28m²
- Permeability ▶ Up to 96%
- Fill ▶ Road base, gravel, pebbles, grass, soil, concrete, asphalt

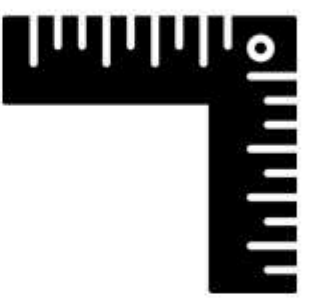

Made from 100% recycled, UV treated polypropylene, TREXLOK is ecologically friendly and highly durable. The product has been load tested by CQ University and found to withstand excessive loads.

TREXLOK VS Comparable Surface Solutions

Surface Consideration:	TREX	TRADITIONAL CONCRETE	TRADITIONAL PAVERS	ASPHALT
Longevity	30+ years	15-20 years	10-15 years	5-10 years
Materials Required	100% recycled UV treated plastic	Cement and steel mesh, framework required	Cement slabs (pre-cast)	Asphalt mixture (tar and aggregate)
Maintenance	Very low - May require some gravel or grass maintenance	Low - prone to cracking and becoming unlevelled	Low - can become cracked and unlevelled	High - Ongoing maintenance, top seal every 2-3 years
Cost & Appearance	Low-cost fills available to blend into the environment.	Black, uniform, industrial, high cost	Options available at a cost	Uniform, options available at a higher cost
Permeability	Up to 100%	N/A	15-30%	N/A
Depth	Varies from 1-2"	Varies from 3-11" depending on application	Varies from 4-6" depending on application / loads	Average of 4 - 4.5"
Eco Friendliness	Low impact, uses recycled materials, movable, reusable, up to 100% permeability, low runoff, breathable ground	High impact, not recyclable or reusable, high ground runoff, ground suffocated, can generate acid	High impact, not recyclable or reusable, requires waster dump if removed, suffocates ground	High impact if dumped/ removed, uses oil based derivatives, not recyclable or reusable, high ground runoff, ground suffocated
Traditional Concrete				
Traditional Pavers				
Asphalt				

TREXPAVE

Specifications

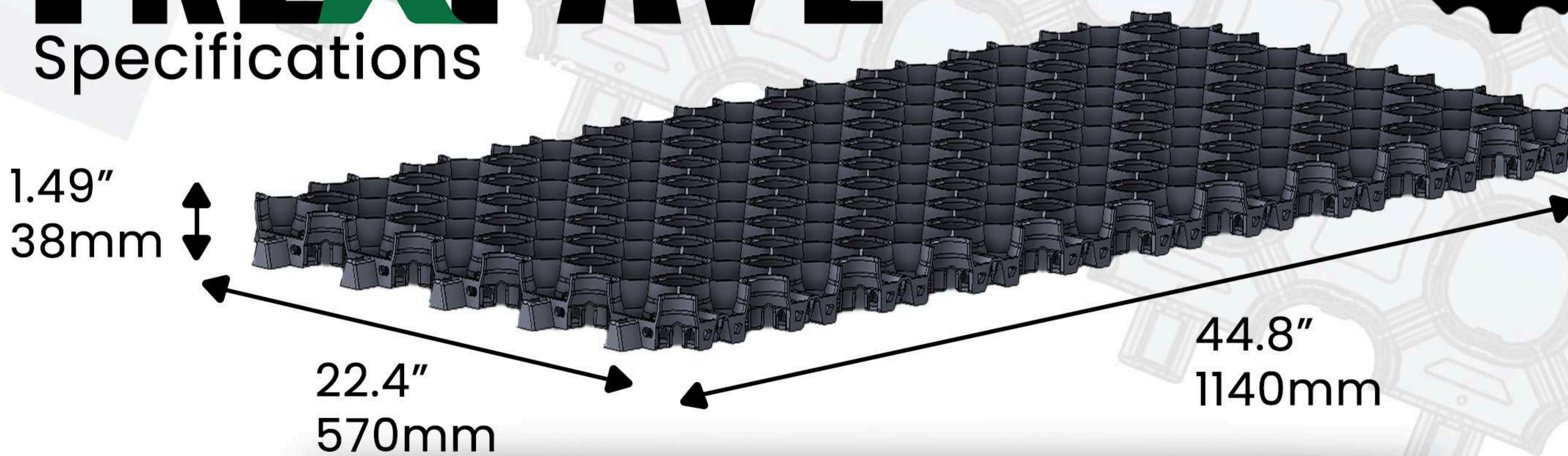

- Measurements ▶ 44.8" W x 22.4" L x 1.49" H - 1140mm W x 570mm L x 38mm H
- Weight per grid ▶ 5.97 lbs - 2.7kg
- Fill ratio ▶ 1 cubic yard of fill per 207.9 square feet - 1 cubic meter of fill per 26m²
- Permeability ▶ Up to 96%
- Fill ▶ Road base, gravel, pebbles, grass, soil, asphalt

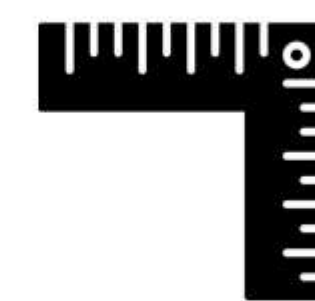





Made from 100% recycled, UV treated polypropylene, TREXLOK is ecologically friendly and highly durable. The product has been load tested by CQ University and found to withstand excessive loads.

TREXPAVE VS Comparable Surface Solutions

Surface Consideration:	TREX	TRADITIONAL CONCRETE	TRADITIONAL PAVERS	ASPHALT	ROADBASE /GRAVEL PAVEMENT
Longevity	30+ years	15-20 years	10-15 years	5-10 years	2-3 years
Materials Required	100% recycled UV treated plastic	Cement and steel mesh, framework required	Cement slabs (pre-cast)	Asphalt mixture (tar & aggregate)	Roadbase
Maintenance	Very low - May require some gravel or grass maintenance	Low - prone to cracking and becoming unlevelled	Low - can become cracked and unlevelled	High - Ongoing maintenance, top seal every 2-3 yrs	High - Ongoing maintenance, repair every 6 months
Cost & Appearance	Low-cost fills available to blend into the environment.	Black, uniform, industrial, high cost	Options available at a cost	Uniform, options available at higher cost	Options available at a cost
Permeability	Up to 100%	N/A	15-30%	N/A	---
Depth	Varies from 1-2"	Varies from 3-11" depending on application	Varies from 4-6" depending on application/loads	Average of 4 - 4.5"	---
Eco Friendliness	Low impact, recycled materials, movable, reusable, up to 100% permeability, low runoff, breathable ground	High impact, not recyclable or reusable, high ground runoff, ground suffocated, can generate acid	High impact, not recyclable or reusable, requires waster dump if removed, suffocates ground	High impact if dumped /removed, uses oil based derivatives, not recyclable or reusable, high ground runoff, ground suffocated	---
Traditional Concrete					
Traditional Pavers					
Asphalt					

TREX Subbase Preparation Guide.

Base Preparation Recommendations for TREX

Load Description	Estimated depth of engineered base		Concrete Pavements	Permeable Pavements
	Subgrade CBR ² 2 – 4 ³	Subgrade CBR ² > 4 ³		
 Heavy Truck Access Gross vehicle loads of 76,000lbs or 78T ¹ . Infrequent passes ⁴ .	6 in (150 mm)	4 in (100 mm)	Page 5	Page 9
 Truck Access Gross vehicle loads of 48,000lbs or 24T. Infrequent passes ⁴ .	4 in (100 mm)	2 in (50 mm)	Page 5	Page 9
 Utility & Delivery Truck Gross vehicle loads of 10,000 lbs or 5T. Infrequent passes ⁴ .	2 in (50mm crushed stone/rock compacted)	2 in (50mm crushed stone/rock compacted)	Page 5	Page 9
 Cars & Pick-up Trucks Gross vehicle loads of 24,000lbs or 12T. Infrequent passes ⁴ .	nil ⁵	nil ⁵	Page 5	Page 9
 Trail Use: Loading for pedestrian, equestrian, motorcycle & ATV traffic.	nil ⁵	nil ⁵	Page 5	Page 9

- 1 Greater Loading**
 TREX may be applied in areas where loading is greater than those listed above. In these situations, call TREX or an authorized representative for specific recommendations.
- 2 CBR**
 CBR is the abbreviation for California Bearing Ratio. Methods for determining CBR vary from more sophisticated laboratory methods to simple field identification methods that use hand manipulation of the soil. TREX does not recommend one method over the other; however, the user must have a high degree of confidence in the results produced by the chosen method.
- 3 Other Than CBR**
 If other-than-CBR soil strength values exist, use available correlation charts to relate the value to CBR.
- 4 Infrequent Passes**
 Infrequent passes means the number of passes over any period of time that causes no lasting damage to the vegetation. This number will be a function of vegetation type and age, climatic conditions, and maintenance practices. This number is not a function of the TREX material.
- 5 No Engineered Base**
 Concrete pavements can be installed without an engineered base for light-use applications. However, an engineer must inspect and approve the project before any work commences.

Concrete Pavements with **TREXLOK**

Installation Guide.

Subgrade Preparation.

Figure 1 - Subgrade Preparation: Graded Prior to compaction and levelling.



- 1** Ensure the surface is cleared of all loose materials to provide a stable base
- 2** Address any discontinuities, such as potholes or cracks, to prevent future structural issues.
- 3** Utilize a skid steer or posi-track equipped with a spreader bar, compact with a roller, to achieve a uniform and compacted surface suitable for the subsequent subbase application.
- 4** Ensure that the pavement are has an even fall of a minimum of 3% fall across the area (This will prevent any water pooling)

Subbase Preparation.

Subbase



Heavy Truck Access Gross vehicle loads of 76,000lbs or 78T.

Road base: 6-inch (150 mm) layer for subgrade CBR between 2 and 4, and a 4-inch (100 mm) layer for subgrade CBR greater than 4.



Truck Access Gross vehicle loads of 48,000lbs or 24T.

Road base: 4-inch (100 mm) layer for subgrade CBR between 2 and 4, and a 2-inch (50 mm) layer for subgrade CBR greater than 4.



Utility & Delivery Truck Gross vehicle loads of 10,000 lbs or 5T.

2-inch (50 mm can be compacted crushed rock/stone) layer for subgrade CBR between 2 and 4, and CBR greater than 4.



No engineered base:

Concrete pavements can be installed without an engineered base for light-use applications below. However, an engineer must inspect and approve the project before any work commences.



Cars & Pick-up Trucks Gross vehicle loads 24,000lbs or 12T.

No engineered base required.



Light Use Pedestrian, equestrian, motorcycle & ATV

No engineered base required.

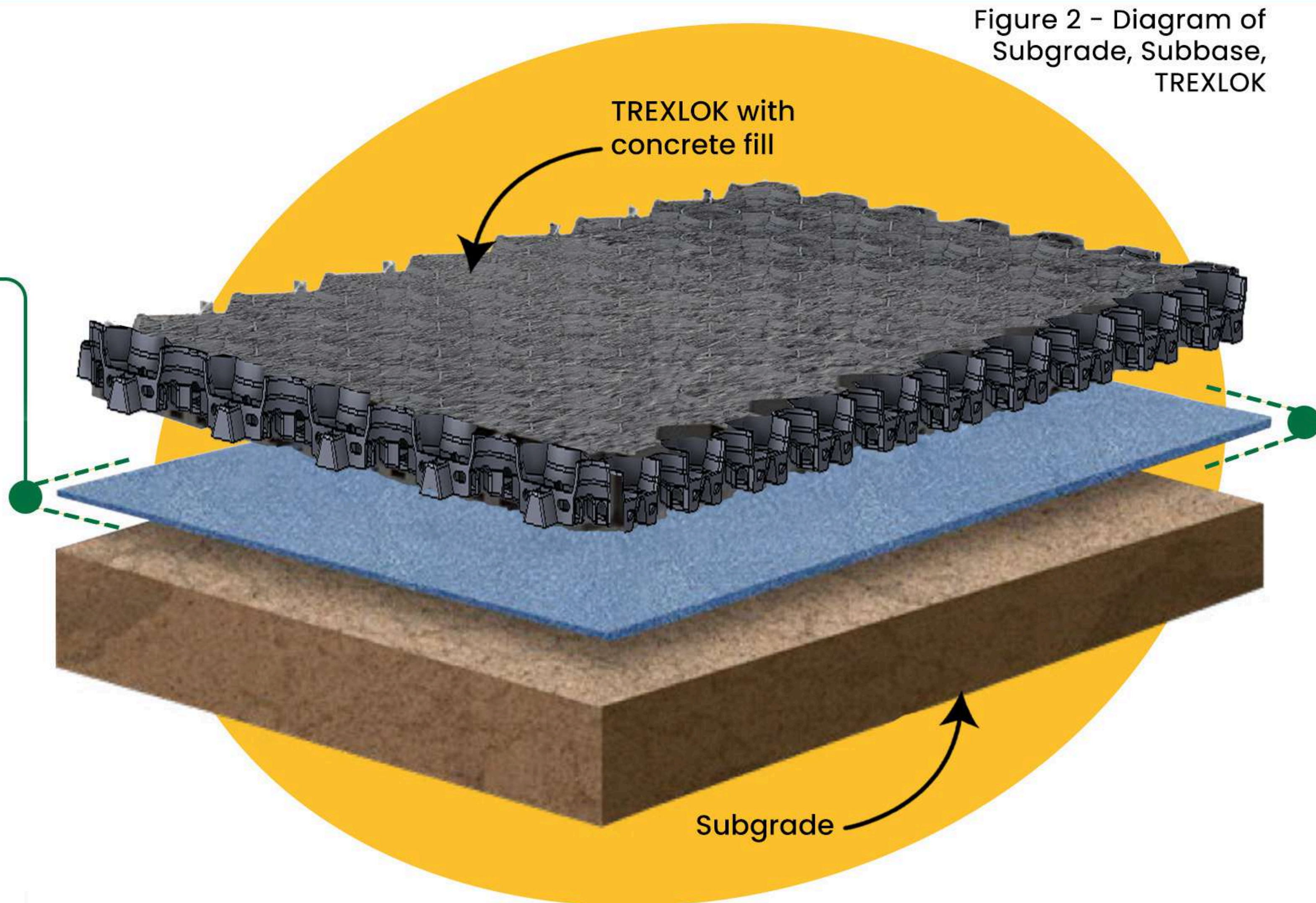

Figure 2 - Diagram of Subgrade, Subbase, TREXLOK

- 4** Cover with road base and compact with rollers to a level 1.5" (38mm) below finish height. See Figure 4.

This guideline is provided as general advice. For specific information regarding surface preparation, please consult with a professional engineer.

- Less than +/- 0.50 cm variation in the plane.
- Compaction level higher than 98% of the Modified Proctor-s Maximum Dry Density.



Figure 4 - Subbase Preparation: Spreading and leveling road base prior to compaction. Compacted and watered, ready for TREXLOK installation

Edging for Standard Pavements.

Figure 5 - Edging for standard pavements using "TREXLOK Edge Strip".

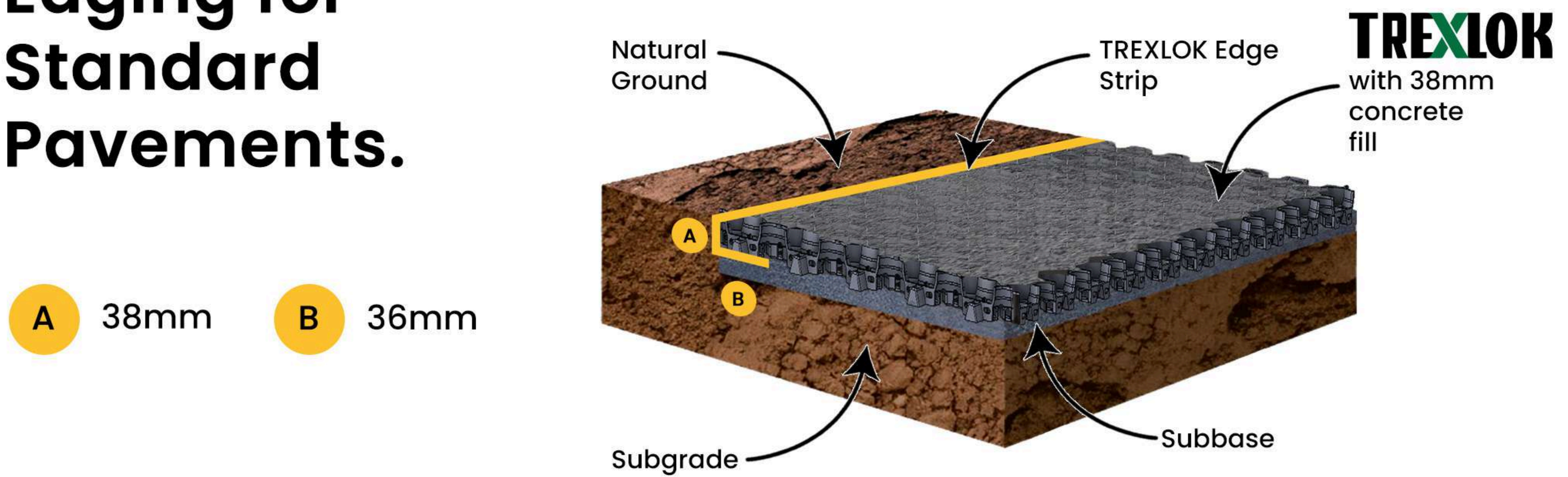

Edging for Heavy Duty Pavements.

Figure 6 - For pavements requiring heavy duty applications that are subjected to heavy loads, edge reinforcement through a flush kerb is required.

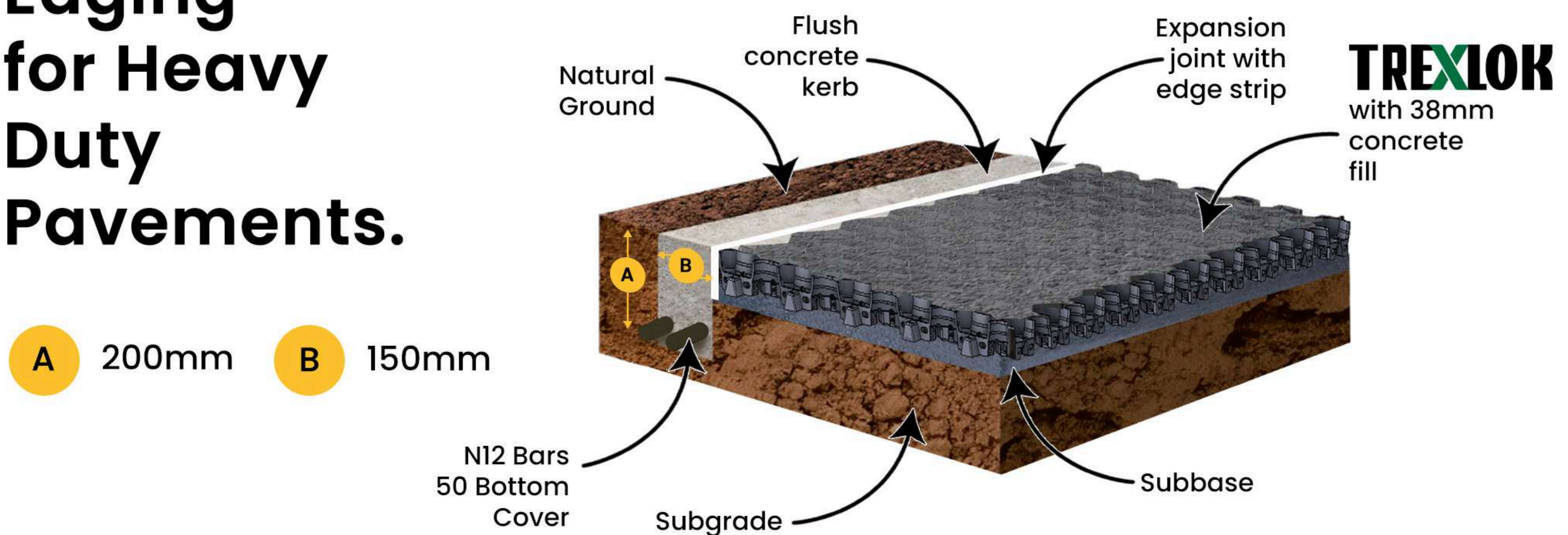

5

Secure the edges firmly to prevent movement, ensure a seamless transition with the pavement ensuring the edging is flush with the 38mm high TREXLOK. See Figures 5 and 6 Edge Diagrams for standard and heavy duty pavements.

6

Seal edges with a trafficable adhesive sealant or TREXLOK rubber extrusion seal after to prevent water ingress. See figure 7.

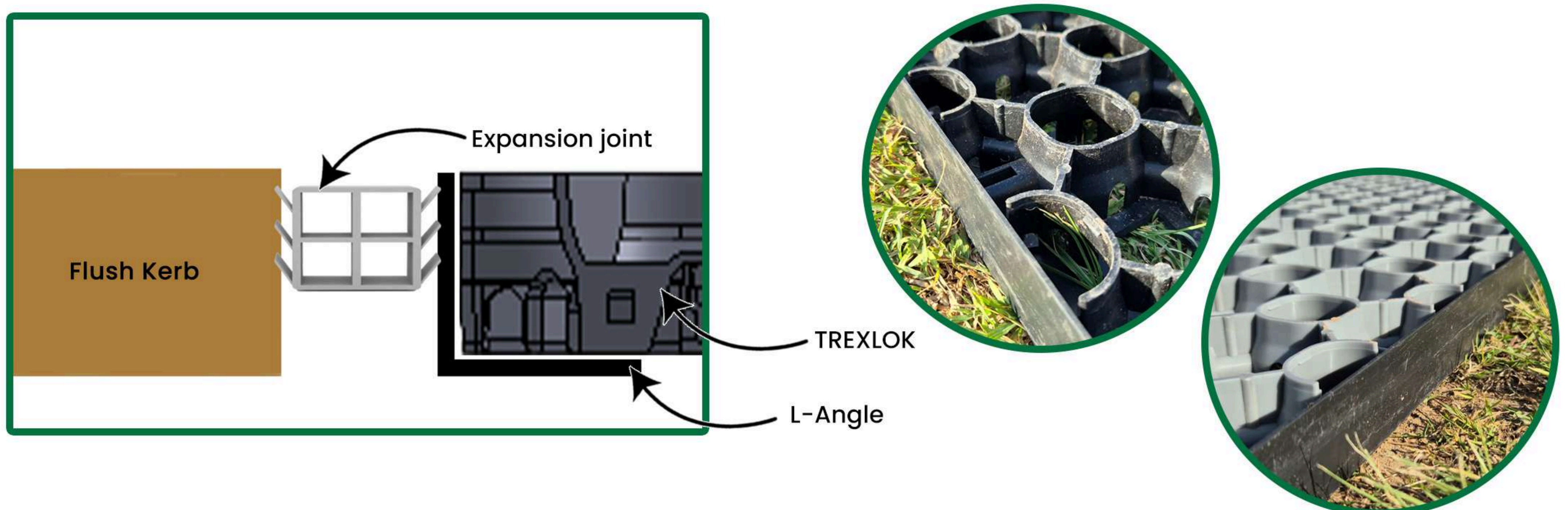

Figure 7 - TREXLOK and expansion joint installation adjacent to Edge Thickening

* More information on expansion joints page 7.

Implementation of TREXLOK

Installation Guide.

- i** Recommended to apply builders plastic before laying TREXLOK to assist in the curing process.
- 7** Begin to assemble the TREXLOK tiles in one corner of the defined area to be covered.
- 8** Lay TREXLOK across the area required starting in a corner with the male lugs facing the edge and the female connectors on the inside ready to connect the next grid. Depress each connection until flat and secure. See Figure 9 & 10 for clarification.
- 9** To cut TREXLOK around objects, use a circular saw or grinder.
- 10** Utilize a roller directly on the TREXLOK to stabilize any displaced tiles and achieve a level surface ready for concrete pour.
- i** **Minimum wastage:** offcuts can be used on opposite sides of the grid.

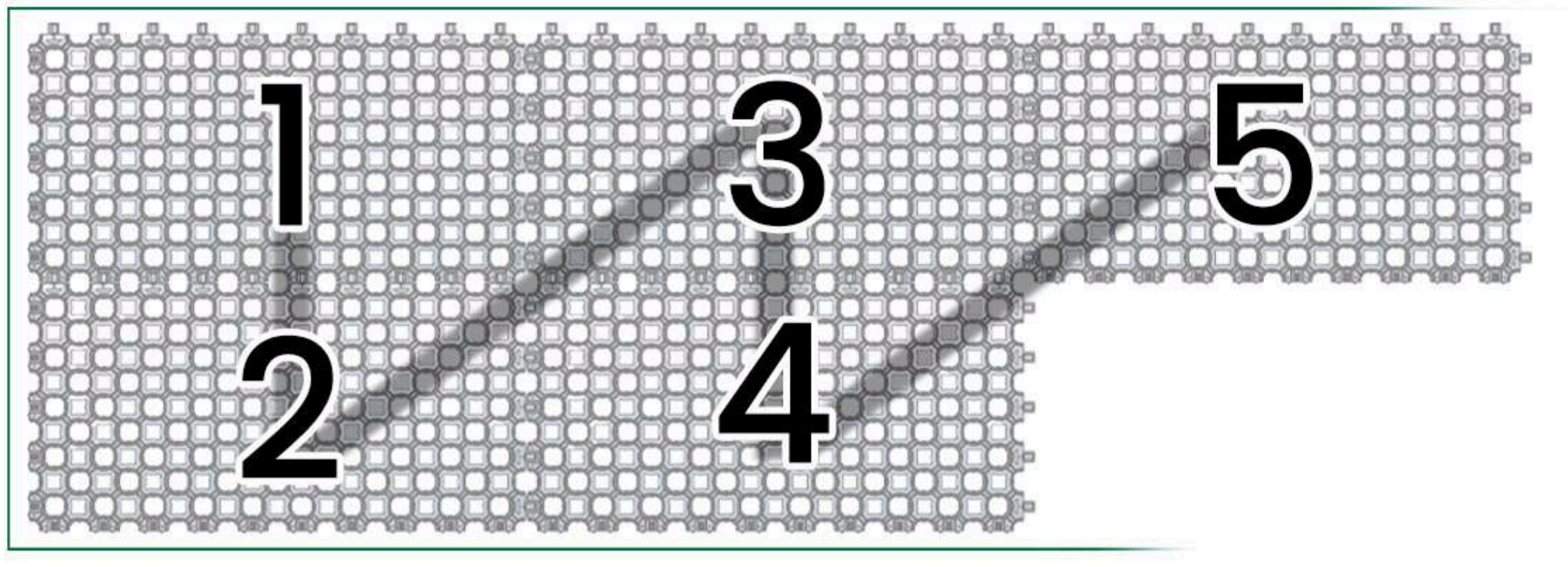

Figure 9 Diagram of laying TREXLOK pattern.

- 11** **Expansion Joints**
TREXLOK modular expansion joint system is crucial for accommodating the natural expansion and contraction of concrete surfaces due to temperature changes. These joints should be placed every 12m x 12m throughout the pavement area, and around any other infrastructure or up against other slabs or abutting pavements.
- *Joint calculation : Before installing TREXLOK for concrete fill we highly recommend you speak to a TrexLok representative regarding your project specifics.



Figure 10 - Cutting TREXLOK to fit around objects easily cut with a circular saw or grinder.



Figure 11 - Rolling in TREXLOK grid before concrete fill.

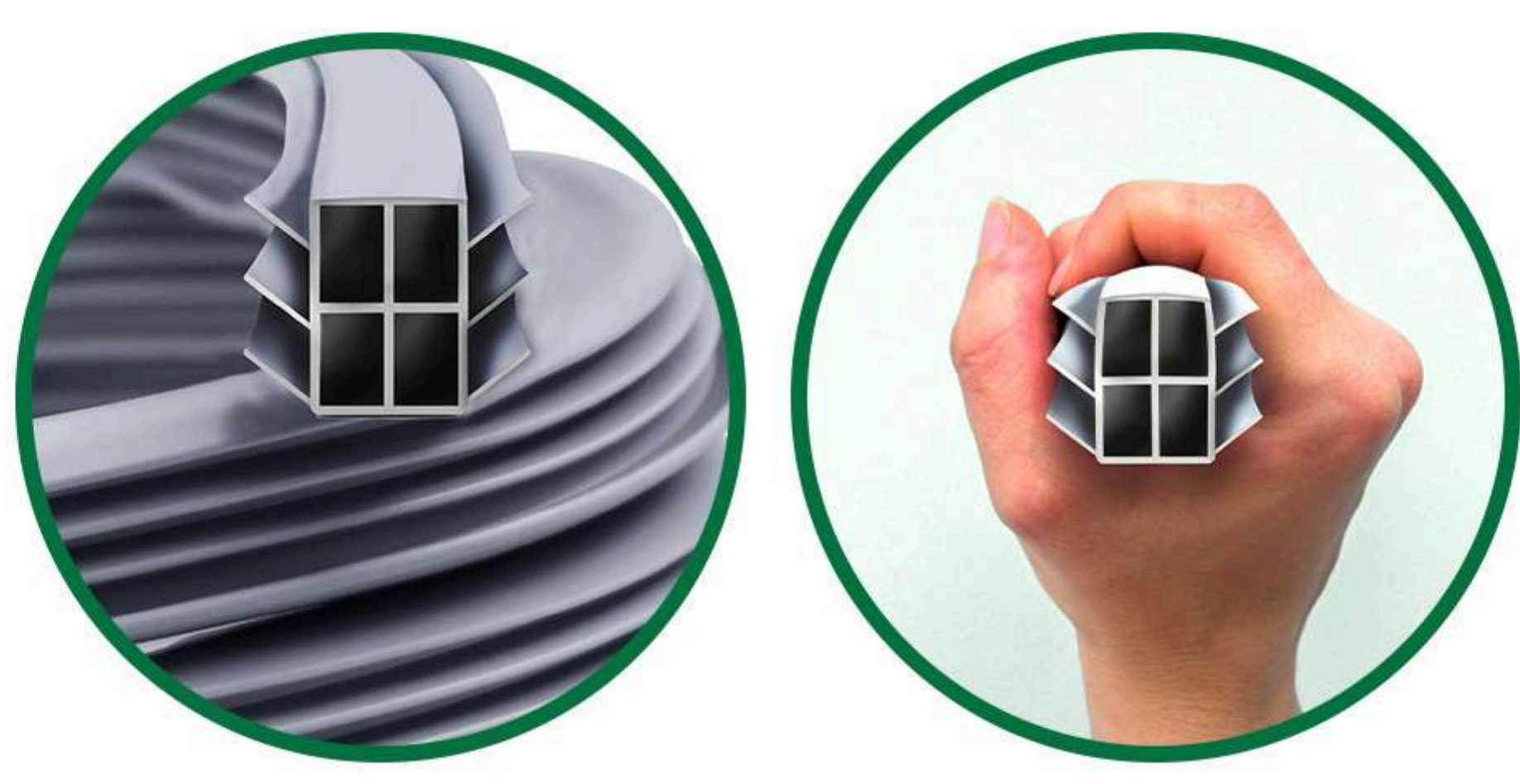
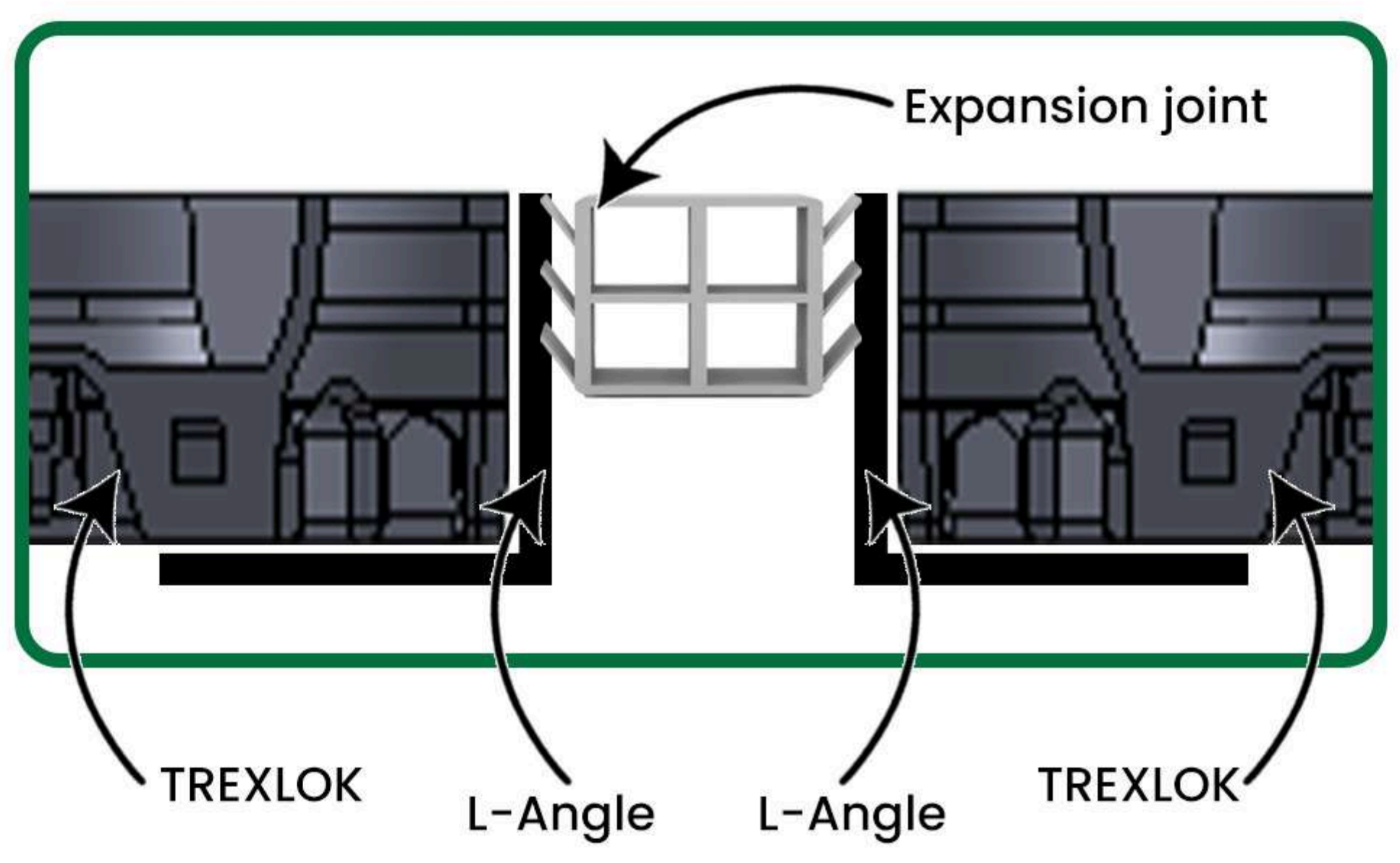

Concrete Fill and Finish of TREXLOK

Concrete Pavement Installation Guide.

Concrete Application.

- 12** Calculate the required volume of concrete.
- 13** If you haven't used builders plastic under the grid, wet the subbase prior to filling with concrete, this helps to slow down the concrete drying time.
- 14** The concrete mix design includes 58% 10mm coarse aggregate and 42% sand, and the amount of cement will depend on the application and the required strength. 120 slump low shrinkage mix is recommended. Discuss mix designs with your TREXLOK representative regarding suitable designs.
- 15** Spread concrete evenly over TREXLOK, filling all spaces with rakes and squeegees. We advise to use a vibrating screed for larger projects.
- 16** Work in sections, finishing using one of three options, a standard trowel machine, bull float or broom finish.
- 17** A curing compound should be applied to the slab surface once installed. Figure 14

i Finish concrete not to exceed the height of the TREXLOK

i Pavement can be used after 24 hours, but for optimal curing, wait up to 5 days



Figure 12 - Concrete mix should be approx 120 slump 10mm stone for easy pouring into TREXLOK.



Figure 13 - Spread concrete evenly over TREXLOK, filling all spaces by hand with rakes and squeegees or vibrating screed for larger projects.

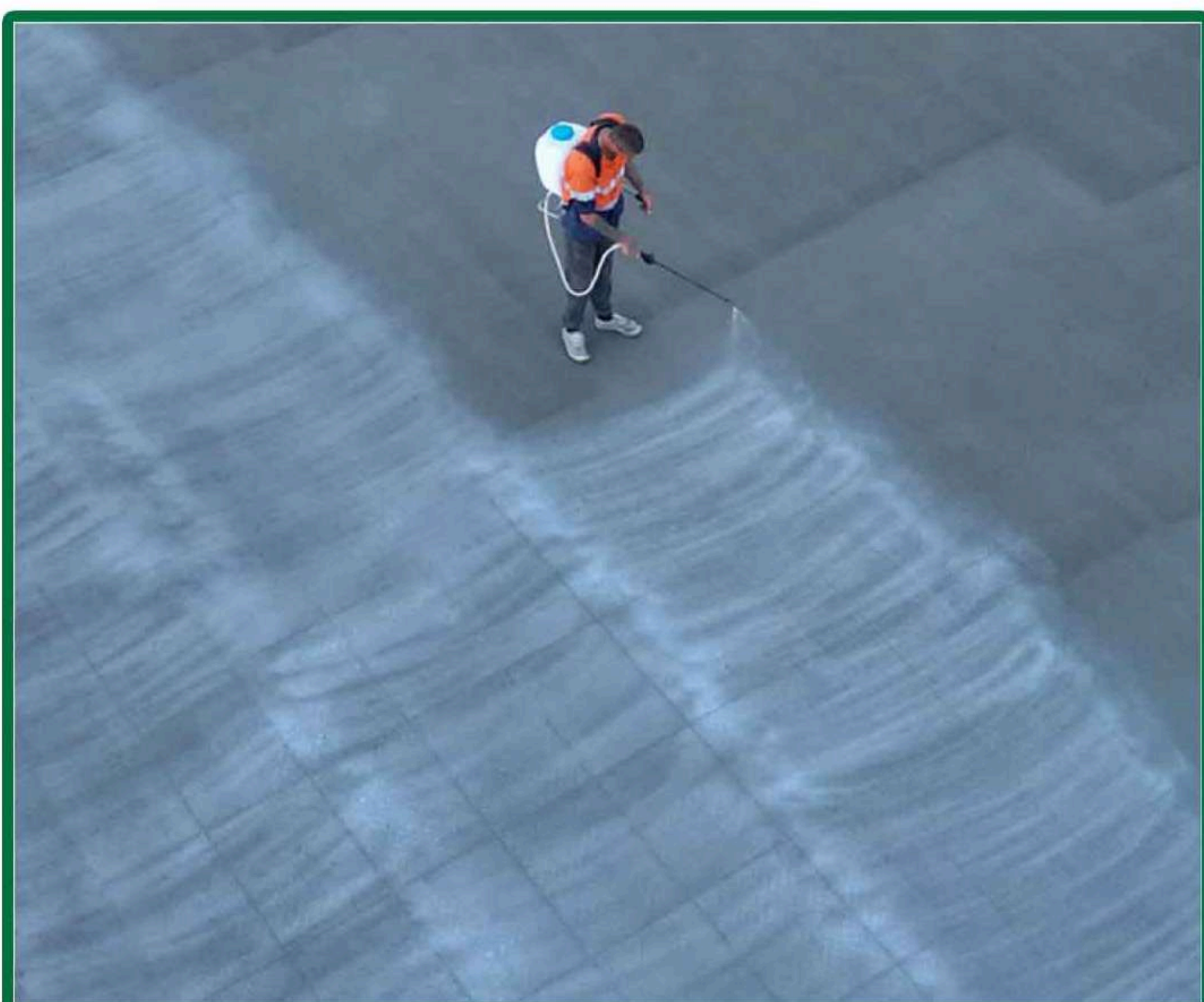

Figure 16 - A curing compound should be applied to the slab surface once installed.



Figure 15 - Concrete finishing work in sections, using a trowel machine.

Permeable Pavement with TREX

Unbound Pavement Installation Guide.

Subgrade Preparation.

- 1** Ensure the surface is cleared of all loose materials to provide a stable base.
- 2** Address any discontinuities, such as potholes or cracks, to prevent future structural issues.
- 3** Utilize a skid steer or posi-track equipped with a spreader bar, compact with a roller, to achieve a uniform and compacted surface suitable for the subsequent subbase application.



Figure 16 - Subgrade Preparation: Graded and compacted.

Subbase Preparation.

Figure 16 - Permeable Unbound Pavement with engineered subbase

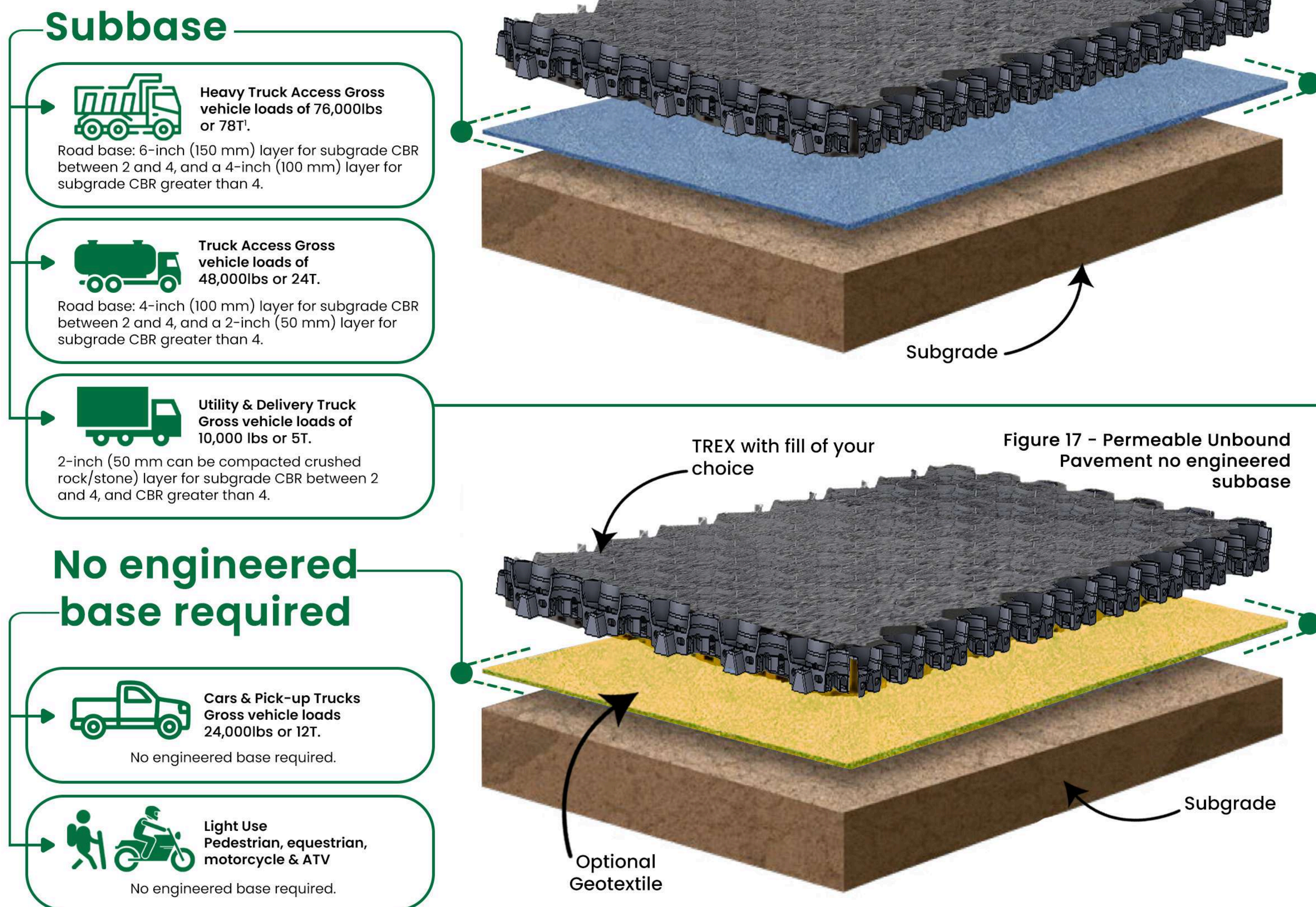
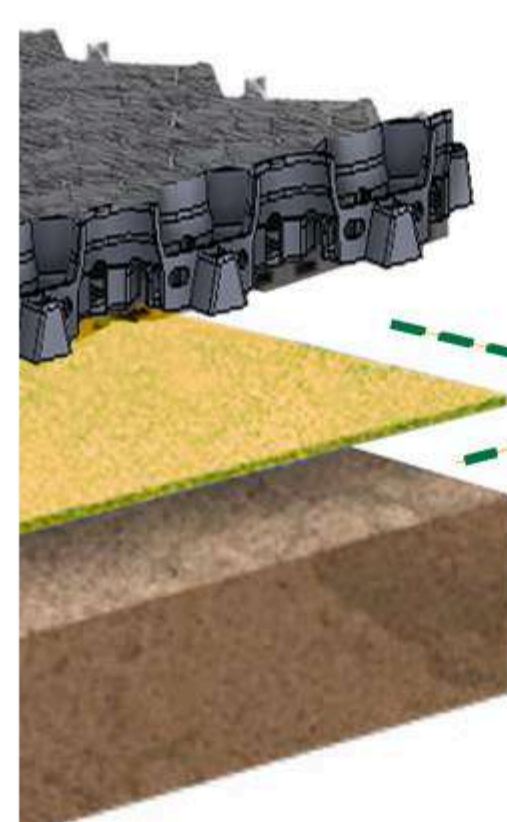

Figure 17 - Permeable Unbound Pavement no engineered subbase

i Light Traffic Permeable Unbound Pavement can be enhanced with an optional geotextile for added stability and performance.



If using a Geotextile, cover with road base and compact with rollers to a level 1.5" (38mm) below finish height.

i If the site is still uneven, 0.4" (10mm) of crushed 0.2" (5mm) minus rock and fines can be spread as bedding.

This guideline is provided as general advice. For specific information regarding surface preparation, please consult with a professional engineer.

Implementation of TREX

Installation Guide.

- 5** Begin to assemble the TREX tiles in one corner of the defined area to be covered.
 - 6** Lay TREX across the area required starting in a corner with the female lugs facing the edge and the male connectors on the inside ready to connect the next grid. Depress each connection until flat and secure. See Figures 21 - 23 for clarification.
 - 7** To cut TREX around contours and obstructions, use a circular saw or grinder.
 - 8** Utilize a roller directly on the TREX to stabilize any displaced tiles and achieve a level surface ready for fill.
- i** **Minimum wastage:** offcuts can be used on the opposite side

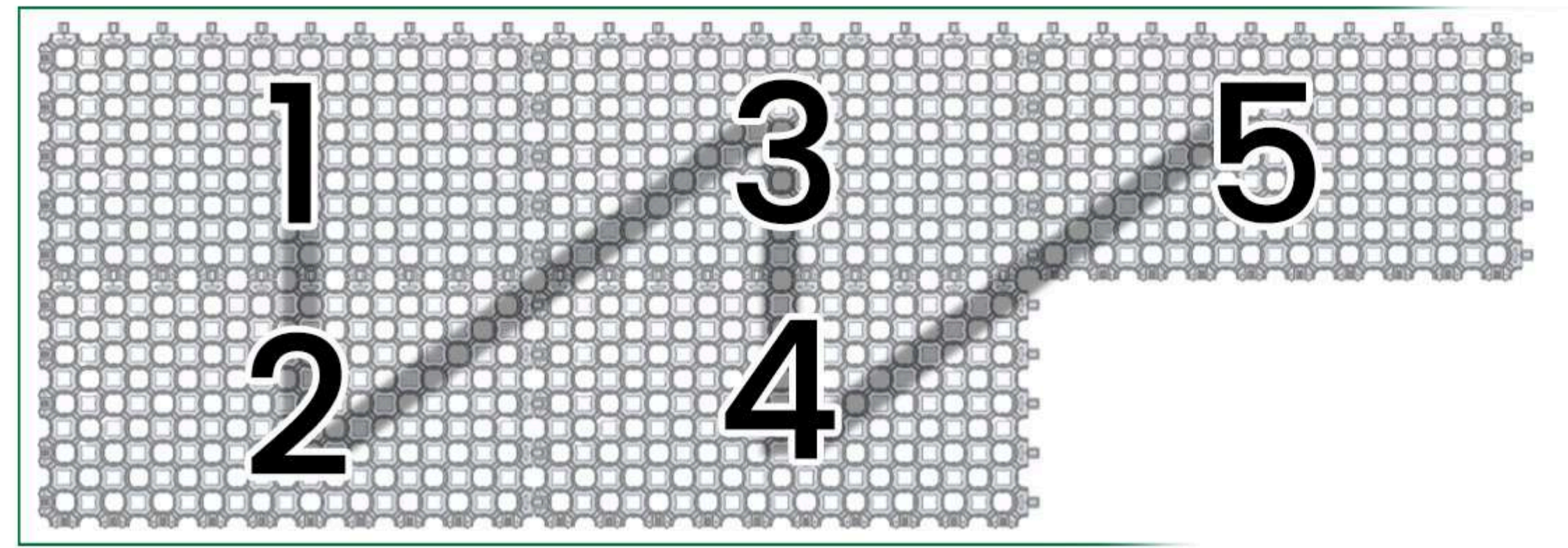

Figure 21 - Diagram of laying TREX pattern.



Figure 23 - laying TREX pattern.



Figure 24 - Depress each connection until flat and secure.



Figure 26 - TREX cut and ready for fill. Offcuts can be used on the opposite side ensuring minimum wastage.

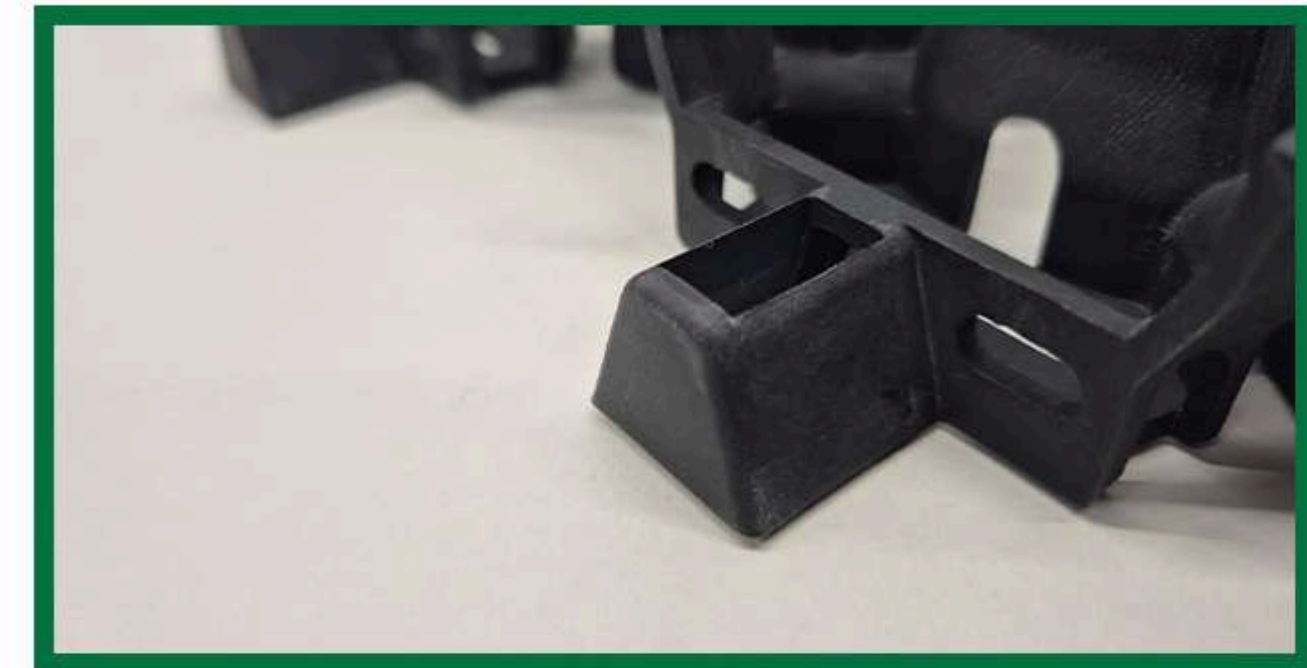

Female Connectors

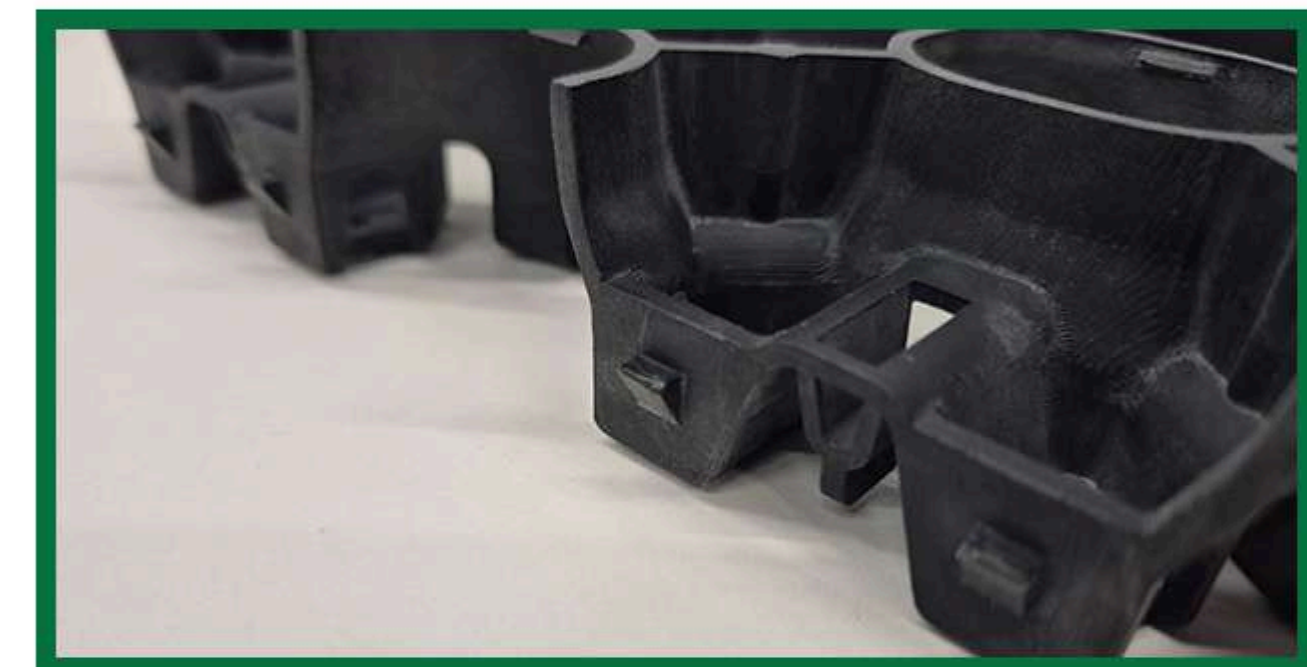

Male lugs

Figure 22 - Start laying TREX in a corner with male lugs facing the edge and female connectors ready to attach the next grid, depress each connection securely until flat.

Built to adapt, TREX offers a variety of fill applications for your project's suitability.



Asphalt

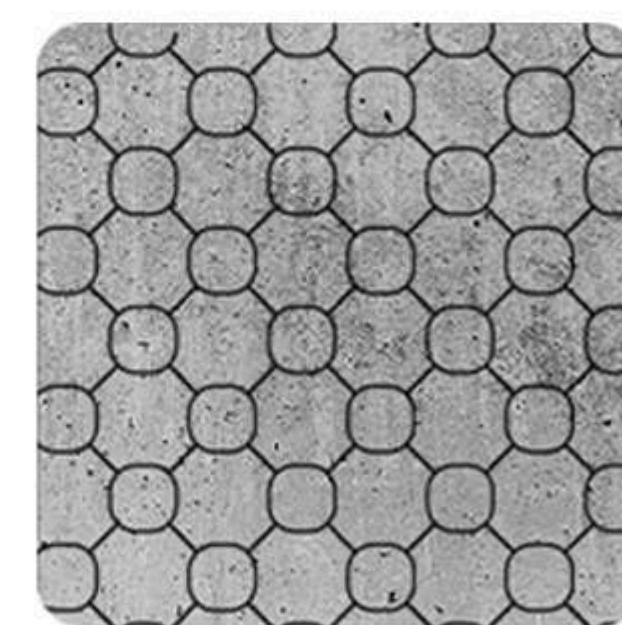

Concrete
only with TREXLOK



Stone



Turf



Roadbase

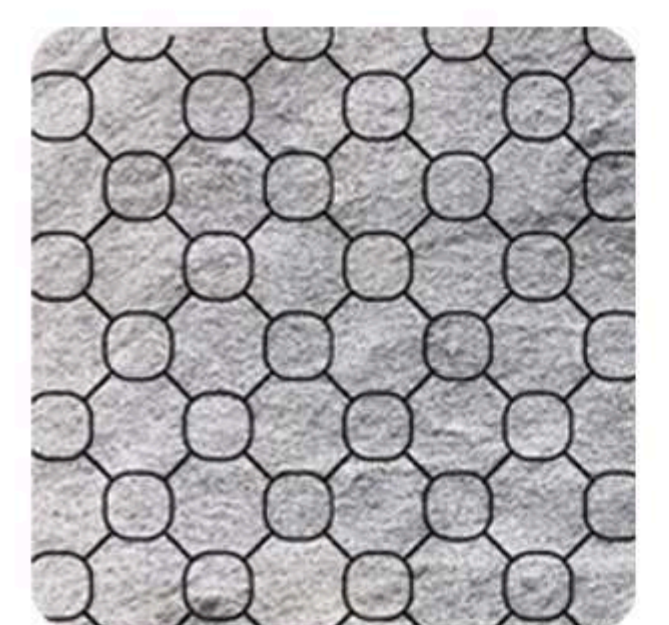

Crushed stone

9 Fill the TREX with your choice of recommended fill materials using a skid steer and spreader bar or similar.

The best type of fill ranges for a variety of different applications. Nothing larger than a 12mm aggregate should be placed into the grid.

10 In the initial weeks post-installation, assess the pavement to verify that the grid remains completely filled. Subsequently, conduct periodic maintenance checks and replenish the grid as necessary.

i Do not overfill the grid as this is likely to work against the performance of the grid.



Figure 27 - Filling TREX with aggregate.



Figure 30 - Completed TREX permeable unbound pavement.



Figure 28 - Utilizing a skid steer (ideally with a spreader bar) to efficiently infill TREX.



Figure 29 - Use a concrete rake to help spread evenly.

TREXSPOT Pavement delineators

TREXSPOT is a versatile delineation marker designed for use within the TREXPAVE and TREXLOK engineered trafficable surface systems.

Available in Yellow, Green, White, and Blue, TREXSPOT is ideal for line marking, pedestrian crossings, traffic arrows, or any area requiring clear guidance and separation.

Proudly made in Australia from recycled materials, TREXSPOT combines durability, sustainability, and functionality in one simple solution.

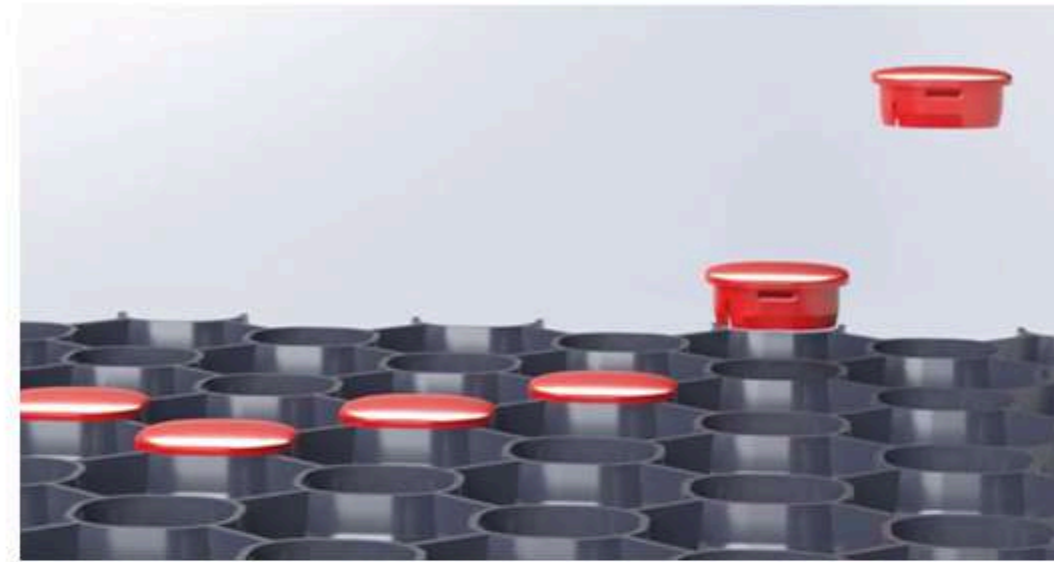

100%
Recycled



100%
Designed, crafted, and
proudly made in **Australia.**

Pavement delineators are used to improve visibility, safety, and traffic guidance in a variety of settings. They help drivers, pedestrians, and machinery operators identify road edges, lanes, and hazards – especially in low-light or poor-weather conditions.

Here's where they are commonly used:



Car Parks and Industrial Areas

- To define parking bays, loading zones, or pedestrian crossings.
- To guide traffic flow in warehouses, factories, or freight terminals.
- Around bollards or hazard zones to prevent vehicle collisions.



Construction and Mining Sites

- To delineate haul roads and safe zones for vehicles and personnel.
- Around equipment areas or storage zones to separate traffic and pedestrians.
- For temporary site access roads, particularly where visibility or dust is an issue.



Commercial and Public Spaces

- Along driveways, shopping centre car parks, and service lanes.
- At entry and exit points to control and guide vehicle movement.
- Around pedestrian pathways for safety demarcation.



Airports, Ports, and Water Infrastructure

- On apron areas, access roads, or maintenance zones.
- To highlight drainage channels, culverts, or edge drop-offs.

Pavement Design Specifications:

All pavement designs must adhere to the "Subbase Preparation Guide" to ensure optimal performance under expected loads and environmental conditions. TREX is not responsible for any issues arising from its use. For questions, please consult your TREX representative.

Installation Procedure:

Installation must follow the "Installation Guide," which provides essential instructions to ensure proper installation and the durability of the pavement system. TREX is not liable for any issues arising from its use. For questions or uncertainties, consult your TREX representative.

Consultation and Support:

If you have any uncertainties or questions during the design or installation process, it is important to consult your TREX representative. They can offer expert advice and ensure that all procedures are accurately followed.

Consultation and Support:

Refrain from Adding Water on-Site: It is crucial to not introduce water to the concrete during the on-site process. Incorporating water can disrupt the mix design and lead to reduced concrete strength.

Edge Leveling and Compaction:

Make sure that the completed edges are level with the adjacent ground. The foundation under the edges needs to be thoroughly compacted to avoid settling and to uphold structural stability.

Concrete Mix Designs

Importance of Mix Design:

The formulation of concrete mixtures is crucial and can differ greatly depending on regional factors. A carefully thought-out mix design guarantees that the concrete will fulfill the required strength and durability standards.

Factors Influencing Mix Design:

To determine the optimal mix design, please contact your TREX representative. The mix design will be customized based on the following factors:

Available Materials:

The local area has access to aggregates, sands, and various mixtures.

Weather Conditions:

The weather on the day of installation can influence how the concrete cures.

Installer Skill Level:

The proficiency of the installers can affect the mix design to suit different levels of expertise.

Application Type:

The particular application criteria, including load-bearing ability and environmental exposure conditions.

Summary:

Following these recommendations ensures the pavement's durability and efficiency. Effective consultation, careful concrete management, and consideration of local mix design factors are vital for successful installation.



Rugged Access



Reinvented.